

GENERAL DESCRIPTION

The SP6685 is a current-regulated charge pump ideal for powering high brightness LEDs for camera flash applications.

The charge pump can be set to regulated two current levels for FLASH and TORCH modes. The SP6685 automatically switches modes between step-up and step-down ensuring that LED current does not depend on the forward voltage. A low current sense reference voltage (50mV) allows the use of small 0603 current sensing resistors.

The SP6685 is designed to operate from a single cell lithium-ion battery or fixed 3.3V or 5.0V power rails and is available in a RoHS compliant, "green"/halogen free space saving 10-pin 3mmx3mm DFN package.

APPLICATIONS

- White LED Torch/Flash for Cell Phone, DSCs and Camcorders
- White LED Backlighting
- Generic Lighting/Flash Application
- General Purpose High Current Boost

FEATURES

- Output Current up to 700mA
- Up to 94% Efficiency in Torch Mode
- Minimum External Components: No Inductor
- Adjustable FLASH Mode Current
- 1x and 2x Charge Pump Operation
- 2.4MHz High Frequency Operation
- $I_Q < 1\mu A$ in Shutdown
- Built-In Soft Start Limit Inrush Current
- Output Overvoltage Protection
- Over current/Temperature Protection
- 10pin 3x3mm DFN Package

TYPICAL APPLICATION DIAGRAM

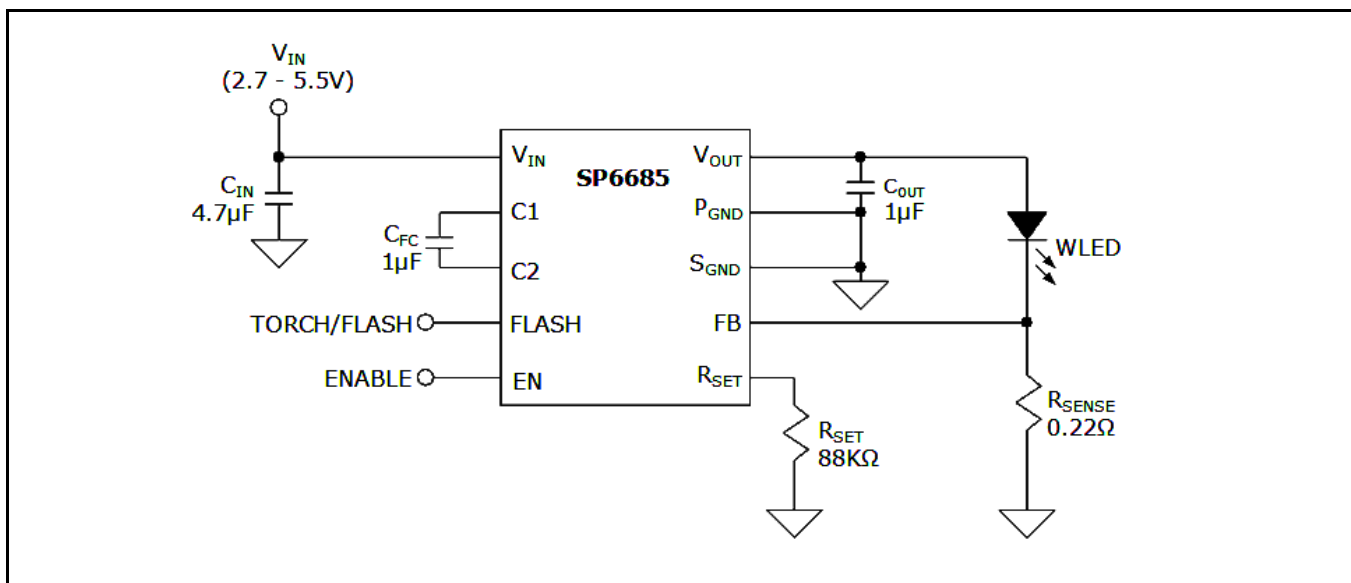

Fig. 1: SP6685 Application Diagram



ABSOLUTE MAXIMUM RATINGS

These are stress ratings only and functional operation of the device at these ratings or any other above those indicated in the operation sections of the specifications below is not implied. Exposure to absolute maximum rating conditions for extended periods of time may affect reliability.

- V_{IN}, V_{OUT} -0.3V to 6.0V
- Output Current Pulse (FLASH) 1A
- Output Current Continuous (TORCH) 0.4A
- V_{EN} 0V to 7V
- Storage Temperature -65°C to 150°C
- Lead Temperature (Soldering, 10 sec) 260°C
- ESD Rating EN pin (HBM - Human Body Model) 1kV
- ESD Rating All Other Pins (HBM) 2kV

OPERATING RATINGS

- Input Voltage Range V_{IN} 2.7V to 5.5V
- Operating Temperature Range -40°C to 85°C
- Thermal Resistance θ_{JA} 57.1°C/W

ELECTRICAL SPECIFICATIONS

Specifications with standard type are for an Operating Junction Temperature of T_J = 25°C only; limits applying over the full Operating Junction Temperature range are denoted by a “•”. Minimum and Maximum limits are guaranteed through test, design, or statistical correlation. Typical values represent the most likely parametric norm at T_J = 25°C, and are provided for reference purposes only. Unless otherwise indicated, V_{IN} = 3.6, C_{IN} = 4.7µF, C_{FC} = C_{OUT} = 1µF. T_A = -40°C to 85°C.

Parameter	Min.	Typ.	Max.	Units	Conditions
Operating Input Voltage	2.7		5.5	V	•
Quiescent Current		0.5	3	mA	• V _{IN} = 2.7 – 5.5V FLASH = 0V I _{LOAD} = 100 µA
		2			
Shutdown Current			1	µA	V _{IN} = 5.5V, V _{EN} = 0V
Oscillator Frequency		2.4		MHz	
Charge Pump Equivalent Resistance (x2 Mode)		5		Ω	V _{FB} = 0V, V _{IN} = 3.6V
Charge Pump Equivalent Resistance (x1 Mode)		0.6	0.8	Ω	V _{IN} = 3.6V
FB Reference Voltage	138	150	162	mV	• FLASH = V _{IN} , R _{SET} = 88.7K
FB Reference Voltage	45	50	55	mV	• FLASH = GND
FB Pin Current			0.5	µA	V _{FB} = 0.3V
EN, Flash Logic Low			0.4	V	•
EN, Flash Logic High	1.3			V	•
EN, Flash Pin Current			0.5	µA	•
V _{OUT} Turn-on Time		250	500	µS	• V _{IN} = 3.6V, FB within 90% of regulation
Thermal Shutdown Temperature		145		°C	

BLOCK DIAGRAM

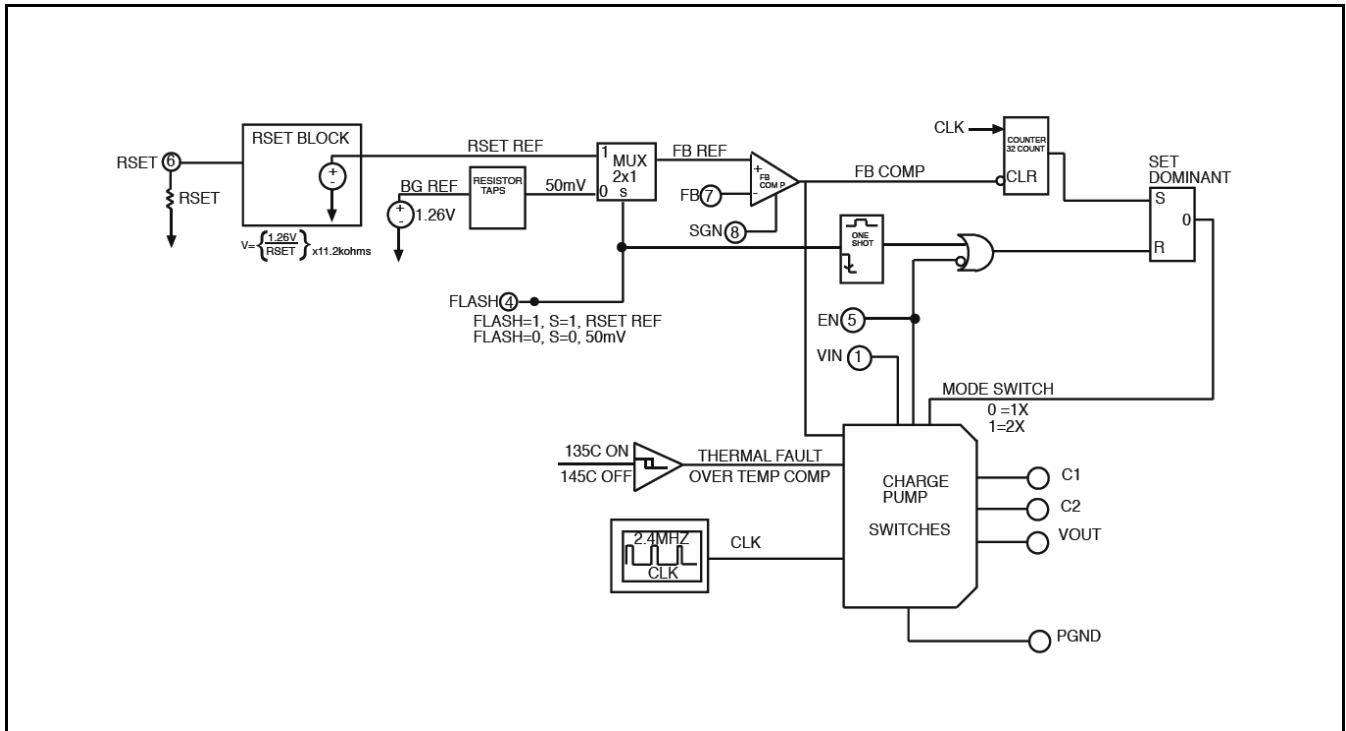

Fig. 2: SP6685 Block Diagram

PIN ASSIGNMENT

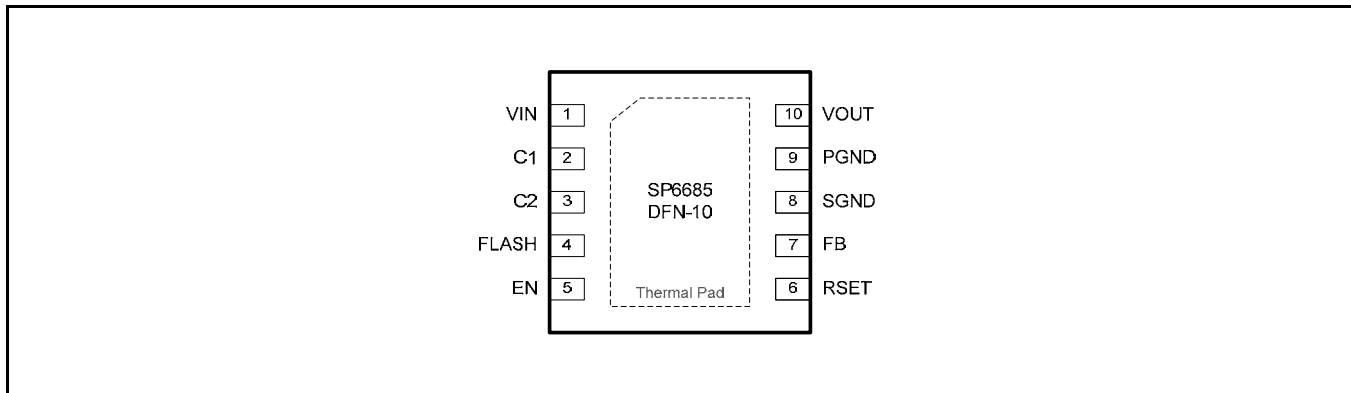

Fig. 3: SP6685 Pin Assignment



PIN DESCRIPTION

Name	Pin Number	Description
V _{IN}	1	Input voltage for the charge pump. Decouple with 4.7µF ceramic capacitor close to the pins of the IC.
C1	2	Positive input for the external fly capacitor. Connect a ceramic 1µF capacitor close to the pins of the IC.
C2	3	Negative input for the external fly capacitor. Connect a ceramic 1µF capacitor close to the pins of the IC.
FLASH	4	Logic input to toggle between FLASH and TORCH mode. In TORCH Mode FB is regulated to the internal 50mV reference. In FLASH Mode FB reference voltage can be adjusted by changing the resistor from R _{SET} pin to ground. Choose the external current sense Resistor (R _{SENSE}) based on desired current in TORCH Mode.
EN	5	Shutdown control input. Connect to V _{IN} for normal operation, connect to ground for shutdown.
R _{SET}	6	Connect a resistor from this pin to ground. When in FLASH Mode (FLASH = High) this resistor sets the current regulation point according to the following: $V_{FB} = (1.26V/R_{SET}) * 11.2K\Omega$
FB	7	Feedback input for the current control loop. Connect directly to the current sense resistor.
S _{GND}	8	Internal ground pin. Control circuitry returns current to this pin.
P _{GND}	9	Power ground pin. Fly capacitor current returns through this pin.
V _{OUT}	10	Charge Pump Output Voltage. Decouple with an external capacitor. At least 1µF is recommended. Higher capacitor values reduce output ripple.

ORDERING INFORMATION

Part Number	Temperature Range	Marking	Package	Packing Quantity	Note 1	Note 2
SP6685ER-L	-40°C ≤ T _A ≤ +85°C	SP66 85ER WWX	DFN-10	Bulk	RoHS Compliant Halogen Free	
SP6685ER-L/TR	-40°C ≤ T _A ≤ +85°C	SP66 85ER WWX	DFN-10	3K/Tape & Reel	RoHS Compliant Halogen Free	
SP6685EB	SP6685 Evaluation Board					

“WW” = Work Week – “X” = Lot Number

TYPICAL PERFORMANCE CHARACTERISTICS

All data taken at $V_{IN} = 3.6V$, Typical Application Circuit, D1 = Luxeon LXCL-PWF1, $T_J = T_A = 25^\circ C$, unless otherwise specified.

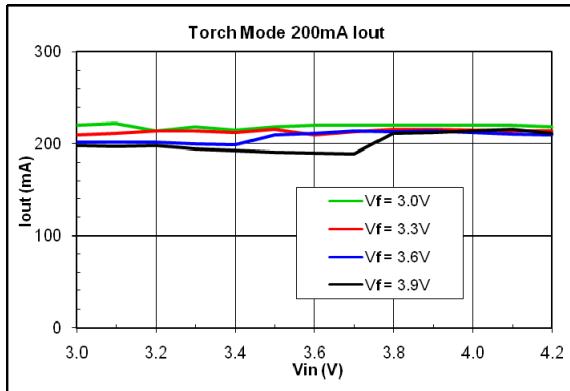

Fig. 4: TORCH Mode Output Current

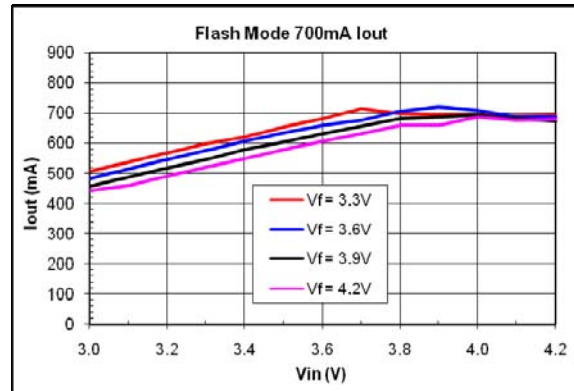

Fig. 5: FLASH Mode Output Current

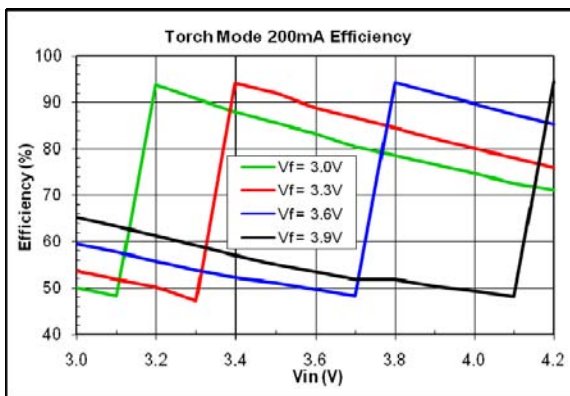

Fig. 6: TORCH Mode Output Efficiency

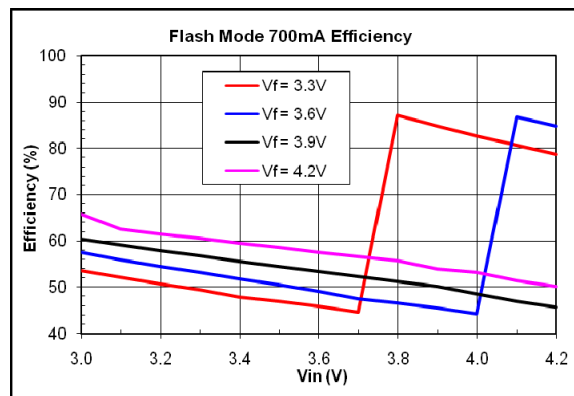

Fig. 7: FLASH Mode Output Efficiency

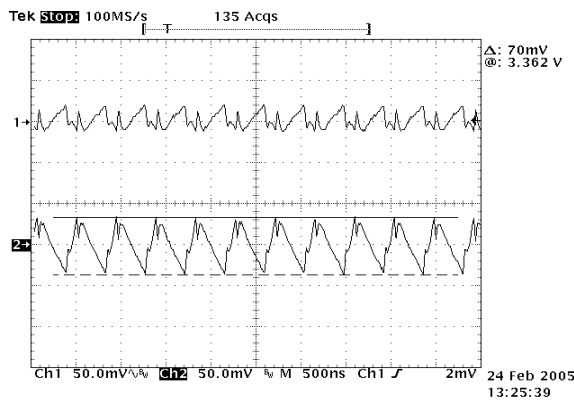

Fig. 8: Ripple 1x FLASH Mode 700mA, CH1 = V_{IN} , CH2 = V_{OUT} , $V_{IN} = 4.2V$, $C_{IN} = 10\mu F$, $C_F = 1\mu F$, $C_{OUT} = 4.7\mu F$

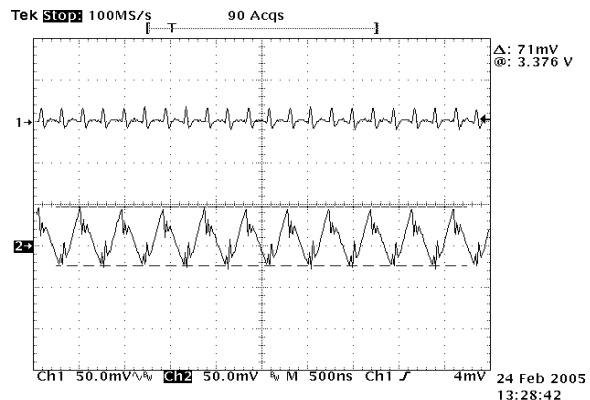

Fig. 9: Ripple 2x FLASH Mode 700mA, CH1 = V_{IN} , CH2 = V_{OUT} , $V_{IN} = 3.6V$, $C_{IN} = 10\mu F$, $C_F = 1\mu F$, $C_{OUT} = 4.7\mu F$

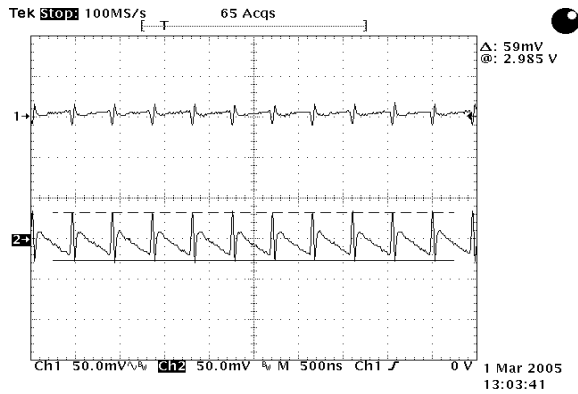

Fig. 10: Ripple 1x TORCH Mode 200mA. CH1 = V_{IN} , CH2 = V_{OUT} , $V_{IN} = 4.2V$, $C_{IN} = 10\mu F$, $C_F = 1\mu F$, $C_{OUT} = 4.7\mu F$

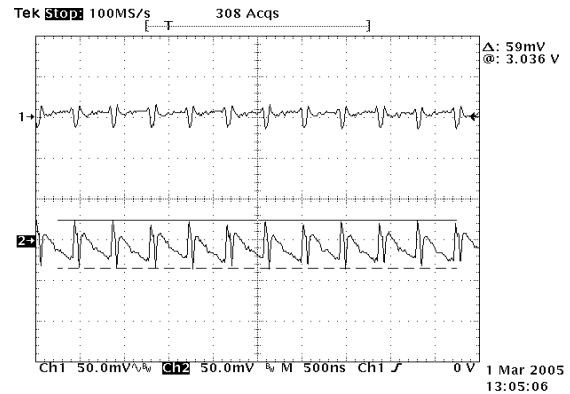

Fig. 11: Ripple 2x TORCH Mode 200mA. CH1 = V_{IN} , CH2 = V_{OUT} , $V_{IN} = 3.0V$, $C_{IN} = 10\mu F$, $C_F = 1\mu F$, $C_{OUT} = 4.7\mu F$

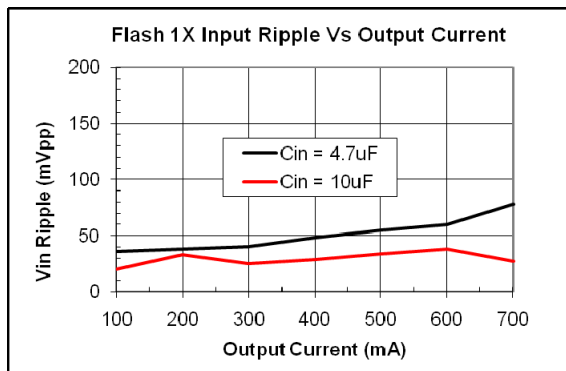

Fig. 12: $C_{OUT} = 4.7\mu F$

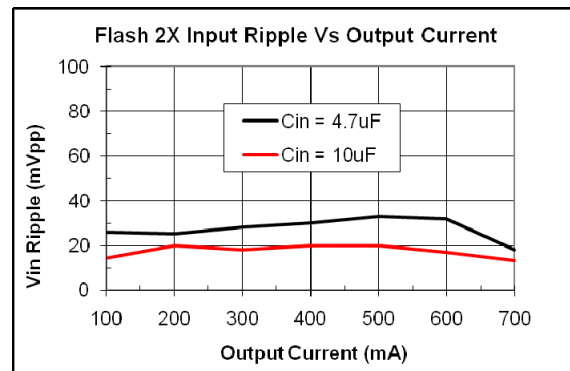

Fig. 13: $C_{OUT} = 4.7\mu F$

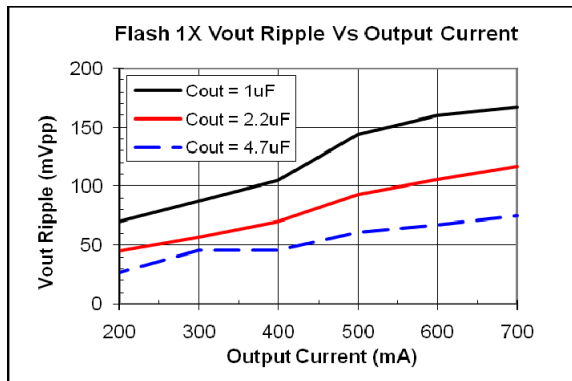

Fig. 14: $C_{IN} = 10\mu F$

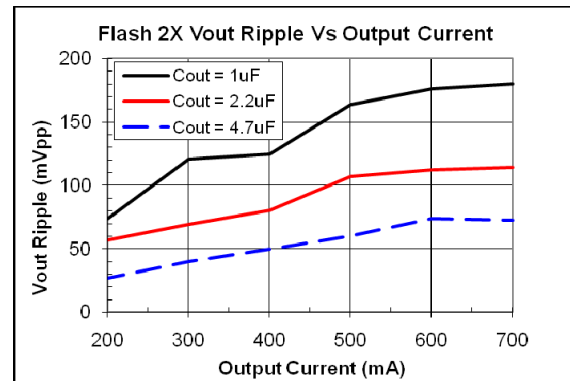

Fig. 15: $C_{IN} = 10\mu F$

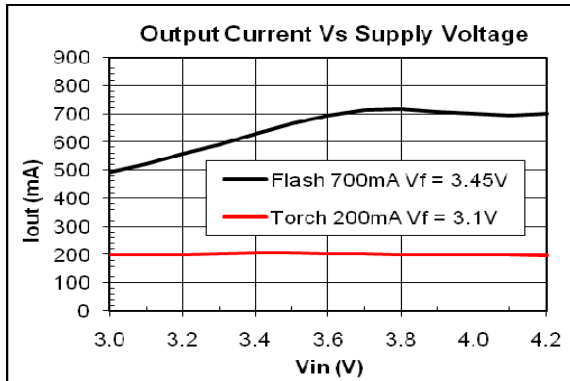

Fig. 16: Output Current vs Supply Voltage

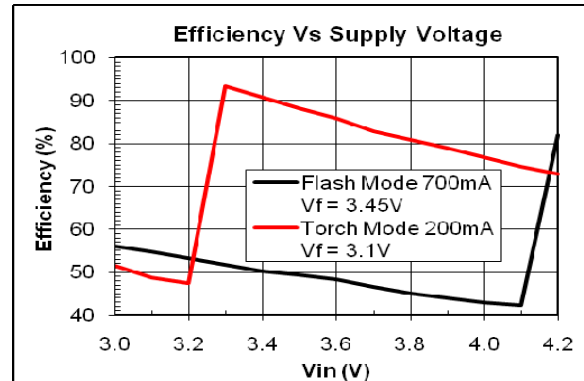

Fig. 17: Efficiency vs Supply Voltage

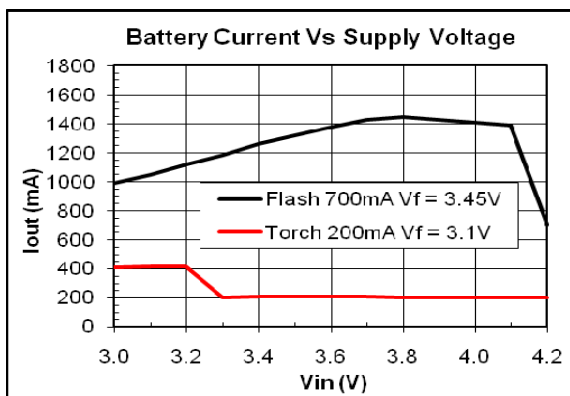

Fig. 18: Battery Current vs Supply Voltage

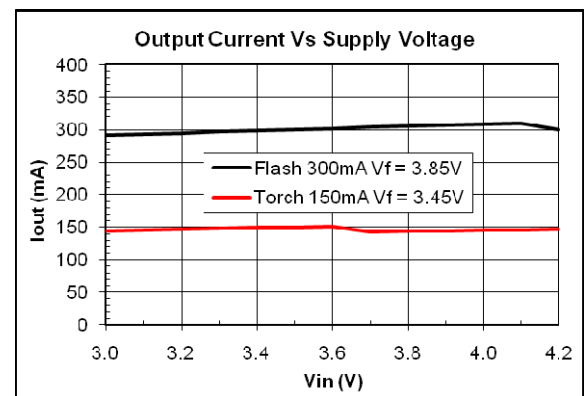

Fig. 18: D1 = AOT 3228HPW0303B LED, $R_{SENSE} = 0.33\Omega$
 $R_{SET} = 162K$, $C_{IN} = 4.7\mu F$, $C_F = 0.47\mu F$, $C_{OUT} = 1\mu F$

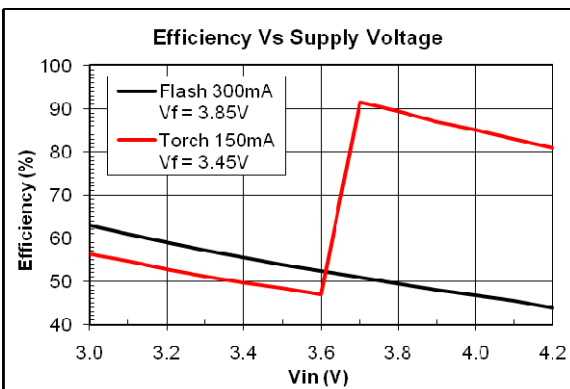

Fig. 20: D1 = AOT 3228HPW0303B LED, $R_{SENSE} = 0.33\Omega$
 $R_{SET} = 162K$, $C_{IN} = 4.7\mu F$, $C_F = 0.47\mu F$, $C_{OUT} = 1\mu F$

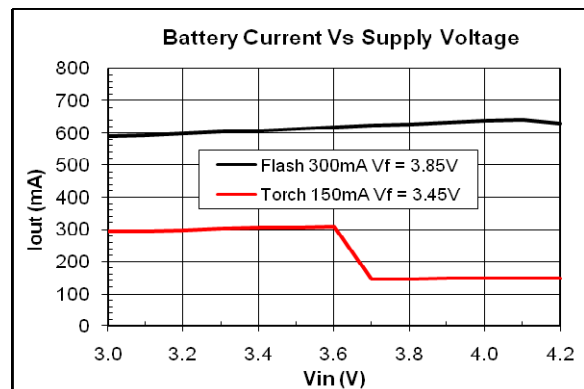

Fig. 21: D1 = AOT 3228HPW0303B LED, $R_{SENSE} = 0.33\Omega$
 $R_{SET} = 162K$, $C_{IN} = 4.7\mu F$, $C_F = 0.47\mu F$, $C_{OUT} = 1\mu F$

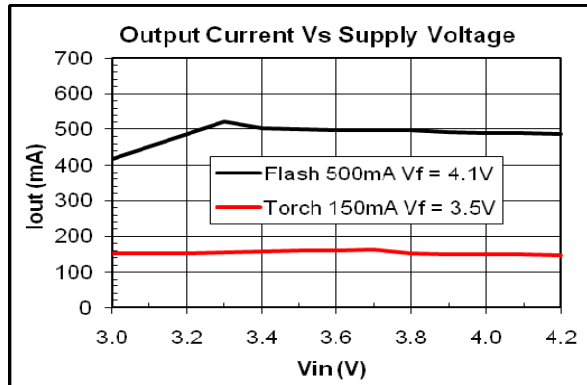

Fig. 22: D1 = AOT 6060HPW0305B LED, $R_{SENSE} = 0.33\Omega$
 $R_{SET} = 75K$, $C_{IN} = 4.7\mu F$, $C_F = 1\mu F$, $C_{OUT} = 1\mu F$

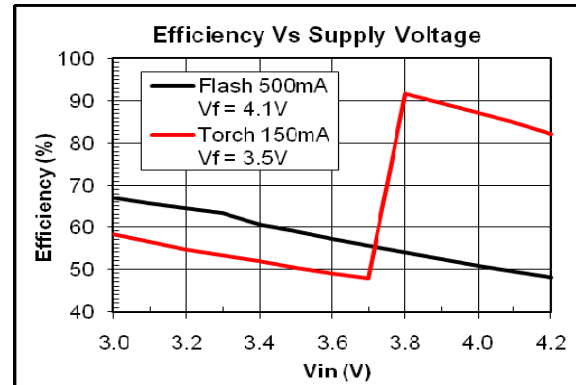

Fig. 23: D1 = AOT 6060HPW0305B LED, $R_{SENSE} = 0.33\Omega$
 $R_{SET} = 75K$, $C_{IN} = 4.7\mu F$, $C_F = 1\mu F$, $C_{OUT} = 1\mu F$

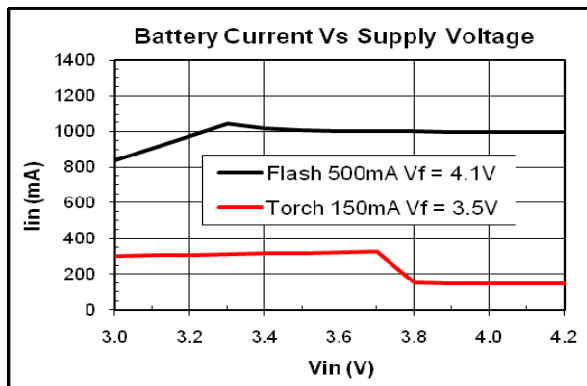

Fig. 19: D1 = AOT 6060HPW0305B LED, $R_{SENSE} = 0.33\Omega$
 $R_{SET} = 75K$, $C_{IN} = 4.7\mu F$, $C_F = 1\mu F$, $C_{OUT} = 1\mu F$

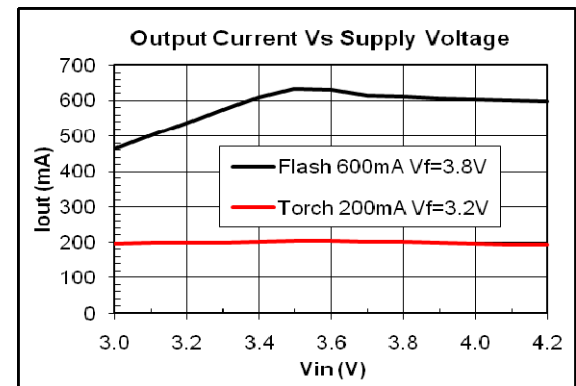

Fig. 20: D1 = AOT 2015HPW1915B LED, $R_{SENSE} = 0.22\Omega$
 $R_{SET} = 80.6K$, $C_{IN} = 4.7\mu F$, $C_F = 1\mu F$, $C_{OUT} = 1\mu F$

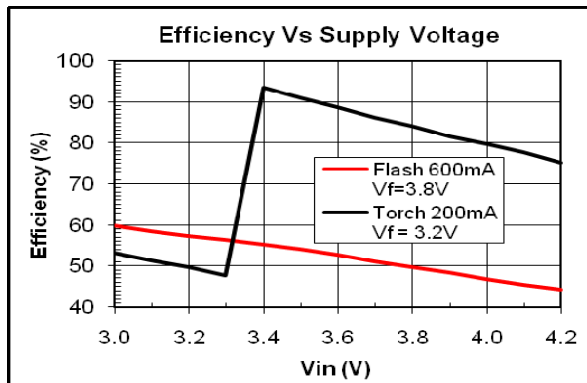

Fig. 26: D1 = AOT 2015HPW1915B LED, $R_{SENSE} = 0.22\Omega$
 $R_{SET} = 80.6K$, $C_{IN} = 4.7\mu F$, $C_F = 1\mu F$, $C_{OUT} = 1\mu F$

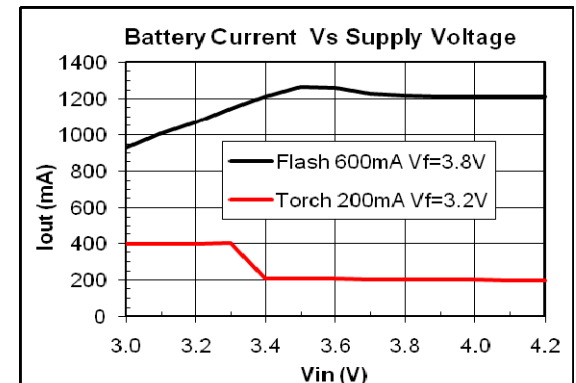

Fig. 27: D1 = AOT 2015HPW1915B LED, $R_{SENSE} = 0.22\Omega$
 $R_{SET} = 80.6K$, $C_{IN} = 4.7\mu F$, $C_F = 1\mu F$, $C_{OUT} = 1\mu F$

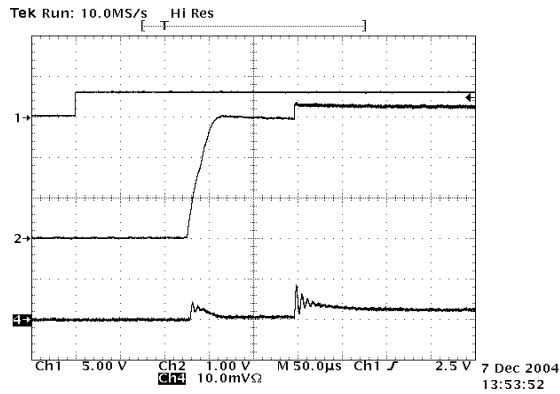

Fig. 28: Startup 200mA Torch
 $V_{IN} = 3.6V, V_{OUT} = 3.2V$

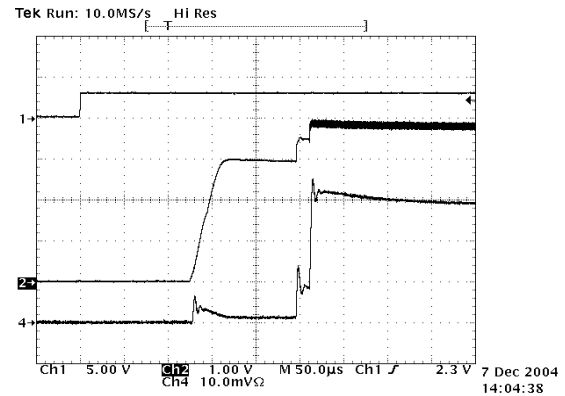

Fig. 29: Startup 700mA Flash
 $V_{IN} = 3.6V, V_{OUT} = 3.6V$

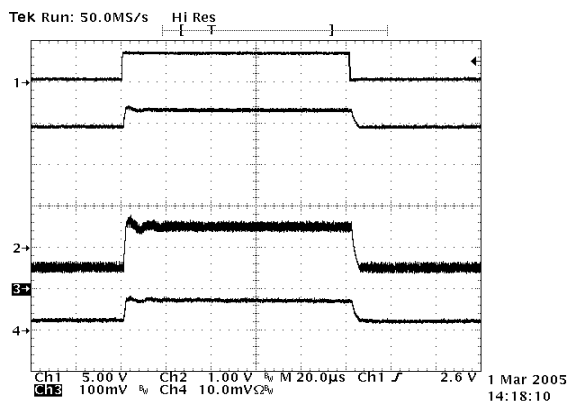

Fig. 30: Torch in 1X to Flash in 1X Mode, $V_{IN} = 4.2V$
 CH1 = FLASH, CH2 = V_{OUT} , CH3 = V_{FB} , CH4 = I_{OUT} 1A/div

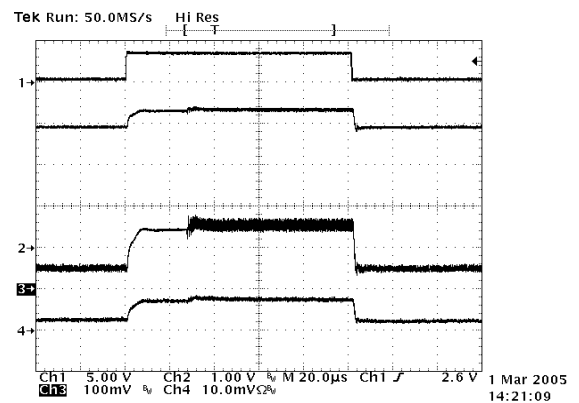

Fig. 31: Torch in 1X to Flash in 2X Mode, $V_{IN} = 3.6V$
 CH1 = FLASH, CH2 = V_{OUT} , CH3 = V_{FB} , CH4 = I_{OUT} 1A/div

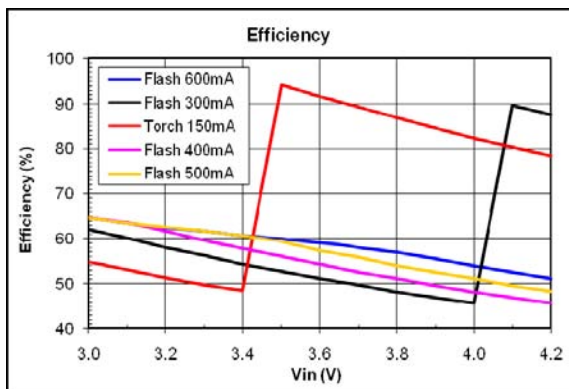

Fig. 32: Efficiency
 See fig.34 for Application Circuit

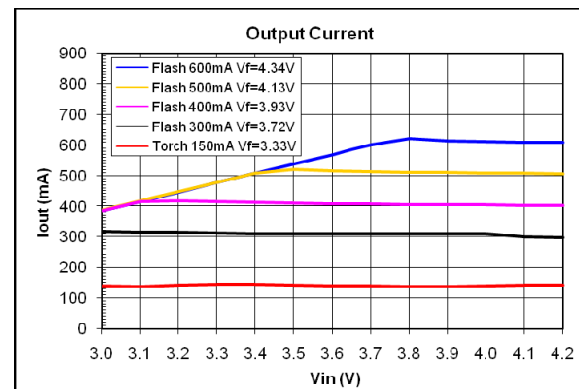

Fig. 33: Output Current
 See fig.34 for Application Circuit

APPLICATION INFORMATION

The SP6685 can be used with multiple LEDs in parallel as shown in figure 34. For best performance, the LEDs should be in a single package, preferably from a single die to have better matching for forward voltage V_f for a given forward current I_f . In practice, if the V_f of one LED is higher than the others, it will consume a larger I_f , which will raise its

temperature which will then cause its V_f to reduce, correcting the imbalance. The overall current will be the sum of the individual currents, for example $I_{total} = 4 \cdot I_{LED}$.

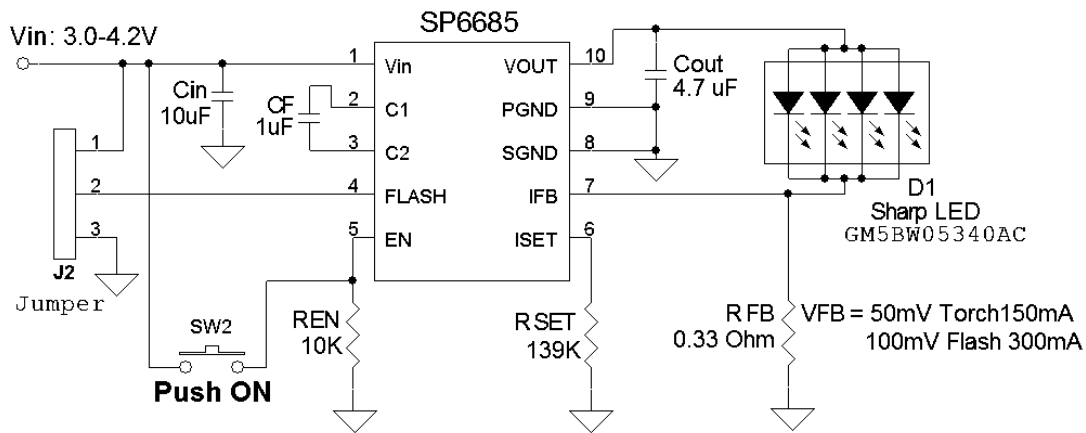

Fig. 34: Multiple LED Flash Circuit

THEORY OF OPERATION

The SP6685 is a charge pump regulator designed for converting a Li-Ion battery voltage of 2.7V to 4.2V to drive a white LED used in digital still camera Flash and Torch applications. The SP6685 has two modes of operation which are pin selectable for either Flash or Torch. Flash mode is usually used with a pulse of about 200 to 300 millisecond to generate a high intensity Flash. Torch can be used continuously at a lower output current than Flash and is often used for several seconds in a digital still camera "movie" mode.

The SP6685 also has two modes of operation to control the output current: the 1X mode and 2X mode. Operation begins after the enable pin EN receives a logic high, the bandgap reference wakes up after about 200µsec, and then SP6685 goes through a soft-start mode designed to reduce inrush current. The SP6685 starts in the 1X mode,

which acts like a linear regulator to control the output current by continuously monitoring the feedback pin FB. In 1X mode, if the SP6685 auto detects a dropout condition, which is when the FB pin is below the regulation point for more than 32 cycles of the internal clock, the SP6685 automatically switches to the 2X mode. The SP6685 remains in the 2X mode until one of four things happens: 1) the enable pin EN has been toggled, 2) the Flash pin has changed from High to Low, 3) V_{IN} is cycled. 4) a thermal fault occurs.

The 2X mode is the charge pump mode where the output can be pumped as high as two times the input voltage, provided the output does not exceed the maximum voltage for the SP6685, which is internally limited to about 5.5V. In the 2X mode, as in the 1X mode, the output current is regulated by the voltage at the FB pin.

In the Torch mode, (Flash = GND) the Flash pin is set to logic low and the SP6685 IFB pin regulates to 50mV output:

$$V_{FB} = 50\text{mV} \quad (\text{Torch Mode})$$

When in Flash mode, (Flash = V_{IN}), the FB regulation voltage is set by the resistor R_{SET} connected between the R_{SET} pin and S_{GND} and the equation:

$$V_{FB} = (1.26\text{V} / R_{SET}) * 11.2\text{K}\Omega \quad (\text{Flash Mode})$$

Where the 1.26V is the internal bandgap reference voltage and the 11.2K Ω is an internal resistance used to scale the R_{SET} current. Typical values of R_{SET} are 40K Ω to 180K Ω for a range of $V_{FB} = 300\text{mV}$ to 75mV in Flash mode.

The output current is then set in either Flash or Torch mode by the equation:

$$I_{OUT} = V_{FB} / R_{sense}$$

OVERTEMPERATURE PROTECTION

When the temperature of the SP6685 rises above 145°C, the over temperature protection circuitry turns off the output switches to prevent damage to the device. If the temperature drops back down below 135°C, the part automatically recovers and executes a soft start cycle.

OVERVOLTAGE PROTECTION

The SP6685 has over voltage protection. If the output voltage rises above the 5.5V threshold, the over voltage protection shuts off all of the output switches to prevent the output voltage from rising further. When the output decreases below 5.5V, the device resumes normal operation.

OVERCURRENT PROTECTION

The over current protection circuitry monitors the average current out of the $V_{OUT} = 50\text{mV}$ (Torch Mode) pin. If the average output

current exceeds approximately 1Amp, then the over current protection circuitry shuts off the output switches to protect the chip.

COMPONENT SELECTION

The SP6685 charge pump circuit requires 3 capacitors: 4.7 μF input, 1 μF output and 1 μF fly capacitor are typically recommended. For the input capacitor, a larger value of 10 μF will help reduce input voltage ripple for applications sensitive to ripple on the battery voltage. All the capacitors should be surface mount ceramic for low lead inductance necessary at the 2.4MHz switching frequency of the SP6685 and to obtain low ESR, which improves bypassing on the input and output and improves output voltage drive by reducing output resistance. Ceramic capacitors with X5R or X7R temperature grade are recommended for most applications. A selection of recommended capacitors is included in Table 1 below.

Manufacturer	Part Number	Value	Size/Type
muRata	GRM155R60J105K	1 $\mu\text{F}/6.3\text{V}$	0402/X5R
muRata	GRM188R60J475K	4.7 $\mu\text{F}/6.3\text{V}$	0603/X5R
muRata	GRM21BR60J106K	10 $\mu\text{F}/6.3\text{V}$	0805/X5R

Table 1: Recommended Capacitors

The input and output capacitors should be located as close to the V_{IN} and V_{OUT} pins as possible to obtain best bypassing, and the returns should be connected directly to the P_{GND} pin or to the thermal pad ground located under the SP6685. The fly capacitor should be located as close to the C1 and C2 pins as possible. See typical circuit layout (page 13) for details on the recommended layout.

To obtain lower output ripple, the C_{OUT} value can be increased from 1 μF to 2.2 μF or 4.7 μF with a corresponding decrease in output ripple as shown in the Typical Performance Characteristic curves. For output currents of 500mA to 700mA, the recommended C_{FC} fly capacitor value of 1 μF should be used. Output currents in Flash of 100mA to 400mA can use a 0.47 μF C_{FC} but a minimum 1 μF C_{OUT} is still needed.

RESISTOR SELECTION

The sense resistor R_{SENSE} is determined by the value needed in the Torch mode for the desired output current by the equation:

$$R_{SENSE} = V_{FB}/I_{OUT}$$

Where $V_{FB} = 50mV$ (Torch Mode)

Once the R_{SENSE} resistor has been selected for Torch mode, the V_{FB} voltage can be selected for Flash mode using the following equation:

$$V_{FB} = I_{OUT} * R_{SENSE} \text{ (Flash Mode)}$$

Where I_{OUT} is for Flash Mode.

Next, the R_{SET} resistor can be selected for Flash mode using the following equation:

$$R_{SET} = (1.26V/ V_{FB}) * 11.2K\Omega \text{ (Flash Mode)}$$

For an example of 200mA Torch mode and 600mA Flash mode, the values $R_{SENSE} = 0.25\Omega$, $V_{FB} = 150mV$ (Flash Mode), and $R_{SET} = 94K\Omega$ are calculated. The power obtained in the Flash mode would be:

$$P_{FLASH} = V_{FB} * I_{OUT} = 150mV * 600mA = 90mW.$$

The typical 0603 surface mount resistor is rated 1/10 Watt continuous power and 1/5 Watt pulsed power, more than enough for this application. For other applications, the P_{FLASH} power can be calculated and resistor size selected. The R_{SENSE} resistor is recommended to be size 0603 for most applications. The

range of typical resistor values and sizes are shown in table 2.

Part Ref.	Value	Tolerance	Size
R _{SET}	68KΩ	5%	0402
R _{SET}	75KΩ	5%	0402
R _{SET}	82KΩ	5%	0402
R _{SET}	91KΩ	5%	0402
R _{SET}	100KΩ	5%	0402
R _{SET}	110KΩ	5%	0402
R _{SET}	120KΩ	5%	0402
R _{SET}	130KΩ	5%	0402
R _{SET}	140KΩ	5%	0402
R _{SET}	150KΩ	5%	0402
R _{SENSE}	0.22Ω	5%	0603
R _{SENSE}	0.27Ω	5%	0603
R _{SENSE}	0.33Ω	5%	0603
R _{SENSE}	0.39Ω	5%	0603
R _{SENSE}	0.47Ω	5%	0603

Table 2: Resistor Value and Sizes

EVALUATION BOARD CIRCUIT LAYOUT

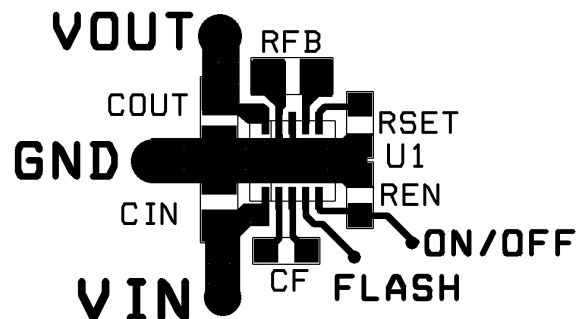

PACKAGE SPECIFICATION

10-PIN DFN

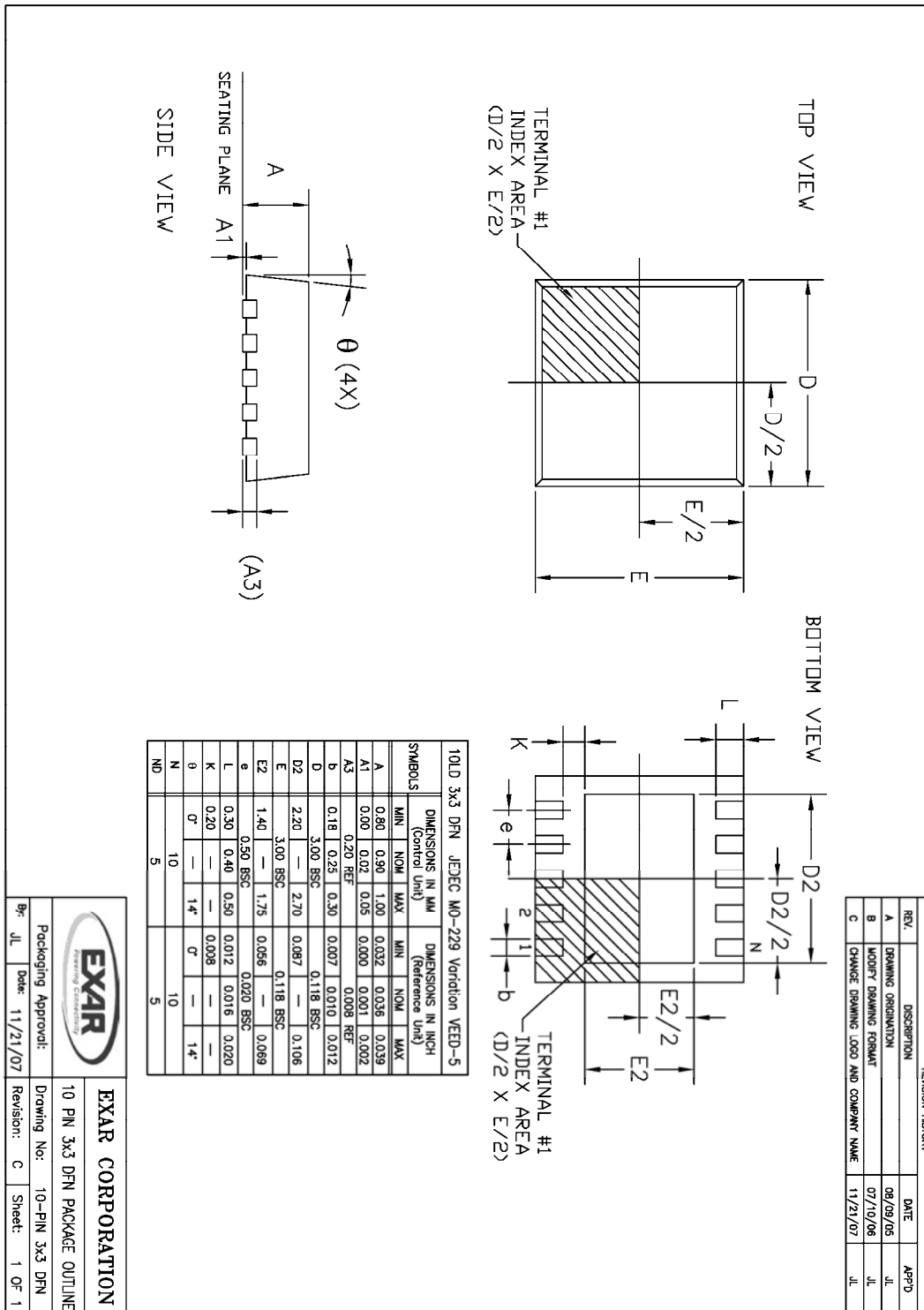

REVISION HISTORY			
REV.	DESCRIPTION	DATE	APP'D
A	DRAWING ORIGINATOR	08/09/05	JL
B	MODIFY DRAWING FORMAT	07/19/06	JL
C	CHANGE DRAWING LOGO AND COMPANY NAME	11/21/07	JL

EXAR CORPORATION

10 PIN 3x3 DFN PACKAGE OUTLINE

Packaging Approval: JL Date: 11/21/07

Drawing No: 10-PIN 3x3 DFN

Revision: C Sheet: 1 OF 1



REVISION HISTORY

Revision	Date	Description
2.0.0	06/18/2009	Reformatted to corporate standard Updated ESD level for EN pin.

FOR FURTHER ASSISTANCE

Email: customersupport@exar.com
Exar Technical Documentation: <http://www.exar.com/TechDoc/default.aspx?>

EXAR CORPORATION

HEADQUARTERS AND SALES OFFICES

48720 Kato Road
Fremont, CA 94538 – USA
Tel.: +1 (510) 668-7000
Fax: +1 (510) 668-7030
www.exar.com



NOTICE

EXAR Corporation reserves the right to make changes to the products contained in this publication in order to improve design, performance or reliability. EXAR Corporation assumes no responsibility for the use of any circuits described herein, conveys no license under any patent or other right, and makes no representation that the circuits are free of patent infringement. Charts and schedules contained here in are only for illustration purposes and may vary depending upon a user's specific application. While the information in this publication has been carefully checked; no responsibility, however, is assumed for inaccuracies.

EXAR Corporation does not recommend the use of any of its products in life support applications where the failure or malfunction of the product can reasonably be expected to cause failure of the life support system or to significantly affect its safety or effectiveness. Products are not authorized for use in such applications unless EXAR Corporation receives, in writing, assurances to its satisfaction that: (a) the risk of injury or damage has been minimized; (b) the user assumes all such risks; (c) potential liability of EXAR Corporation is adequately protected under the circumstances.

Reproduction, in part or whole, without the prior written consent of EXAR Corporation is prohibited.