



N-Channel Enhancement Mode Field Effect Transistor

PRODUCT SUMMARY

V _{DSS}	I _D	R _{DS(ON)} (mΩ) Max
24V	12.5A	4.5 @ V _{GS} =4.5V
		4.7 @ V _{GS} =4.0V
		4.9 @ V _{GS} =3.7V
		5.5 @ V _{GS} =3.1V
		6.0 @ V _{GS} =2.5V

FEATURES

- Super high dense cell design for low R_{DS(ON)}.
- Rugged and reliable.
- Surface Mount Package.
- ESD Protected.

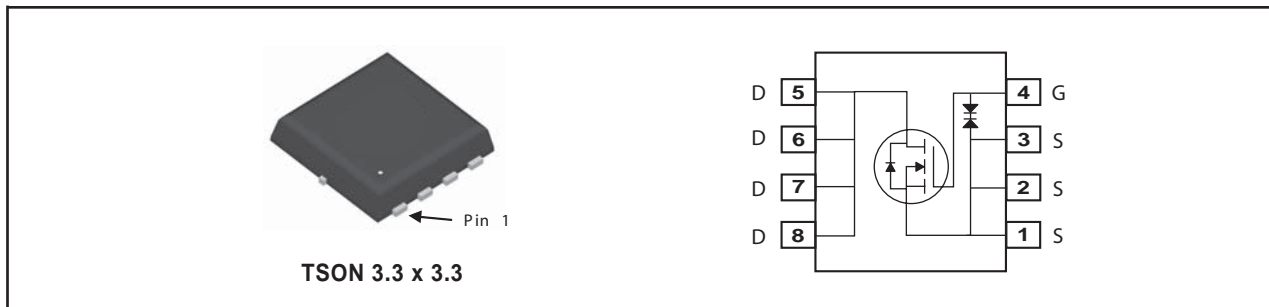

ABSOLUTE MAXIMUM RATINGS (T_A=25°C unless otherwise noted)

Symbol	Parameter	Limit	Units
V _{DS}	Drain-Source Voltage	24	V
V _{GS}	Gate-Source Voltage	±12	V
I _D	Drain Current-Continuous ^a	T _A =25°C	12.5
		T _A =70°C	10
I _{DM}	-Pulsed ^b	81	A
P _D	Maximum Power Dissipation ^a	T _A =25°C	1.67
		T _A =70°C	1.07
T _J , T _{STG}	Operating Junction and Storage Temperature Range	-55 to 150	°C

THERMAL CHARACTERISTICS

Symbol	Parameter	Limit	Units
R _{θJA}	Thermal Resistance, Junction-to-Ambient ^a	75	°C/W

SP8006

Ver 1.1

ELECTRICAL CHARACTERISTICS (T_A=25°C unless otherwise noted)

Symbol	Parameter	Conditions	Min	Typ	Max	Units
OFF CHARACTERISTICS						
BV _{DSS}	Drain-Source Breakdown Voltage	V _{GS} =0V, I _D =250uA	24			V
I _{DSS}	Zero Gate Voltage Drain Current	V _{DS} =20V, V _{GS} =0V			1	uA
I _{GSS}	Gate-Body Leakage Current	V _{GS} = ±12V, V _{DS} =0V			±10	uA
ON CHARACTERISTICS						
V _{GS(th)}	Gate Threshold Voltage	V _{DS} =V _{GS} , I _D =1.0mA	0.5	0.85	1.5	V
R _{DS(ON)}	Drain-Source On-State Resistance	V _{GS} =4.5V, I _D =6.25A	3.3	3.8	4.5	m ohm
		V _{GS} =4.0V, I _D =6.25A	3.5	4.0	4.7	m ohm
		V _{GS} =3.8V, I _D =6.25A	3.6	4.1	4.9	m ohm
		V _{GS} =3.1V, I _D =6.25A	3.8	4.3	5.5	m ohm
		V _{GS} =2.5V, I _D =6.25A	4.0	4.5	6.0	m ohm
g _{FS}	Forward Transconductance	V _{DS} =5V, I _D =6.25A		39		S
DYNAMIC CHARACTERISTICS ^c						
C _{ISS}	Input Capacitance	V _{DS} =10V, V _{GS} =0V f=1.0MHz		2400		pF
C _{OSS}	Output Capacitance			422		pF
C _{RSS}	Reverse Transfer Capacitance			376		pF
SWITCHING CHARACTERISTICS ^c						
t _{D(ON)}	Turn-On Delay Time	V _{DD} =20V I _D =6.25A		50		ns
t _r	Rise Time			139		ns
t _{D(OFF)}	Turn-Off Delay Time	V _{GS} =4.5V R _{GEN} = 6 ohm		110		ns
t _f	Fall Time			59		ns
Q _g	Total Gate Charge	V _{DS} =20V, I _D =12.5A, V _{GS} =4.5V		24		nC
Q _{gs}	Gate-Source Charge			4		nC
Q _{gd}	Gate-Drain Charge			12		nC
DRAIN-SOURCE DIODE CHARACTERISTICS AND MAXIMUM RATINGS						
V _{SD}	Diode Forward Voltage	V _{GS} =0V, I _S =12.5A		0.82	1.2	V
Notes						
a.Surface Mounted on FR4 Board, t ≤ 10sec.						
b.Pulse Test:Pulse Width < 10us, Duty Cycle < 1%.						
c.Guaranteed by design, not subject to production testing.						

Jul,18,2013

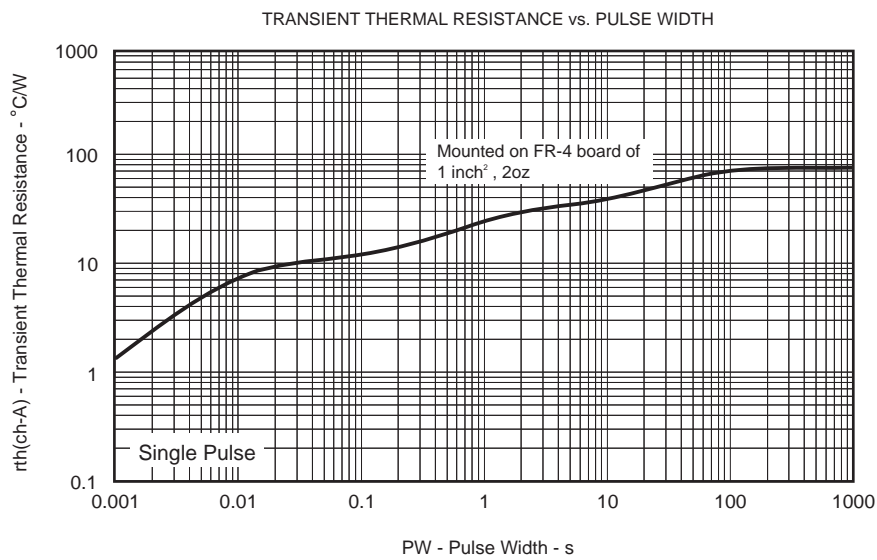
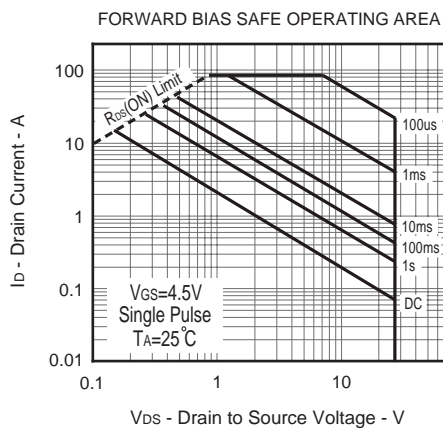
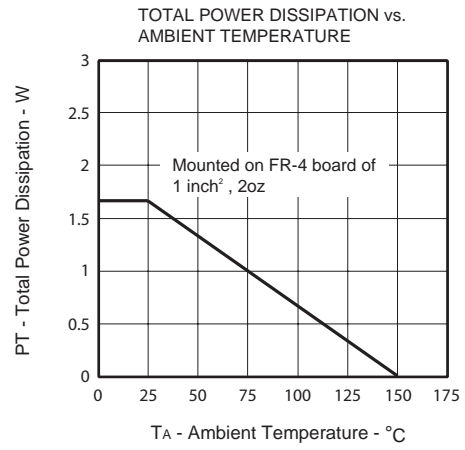
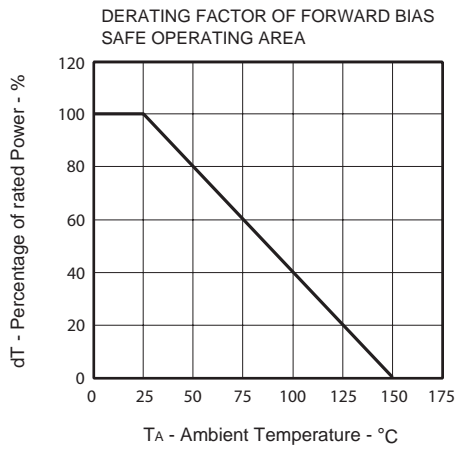

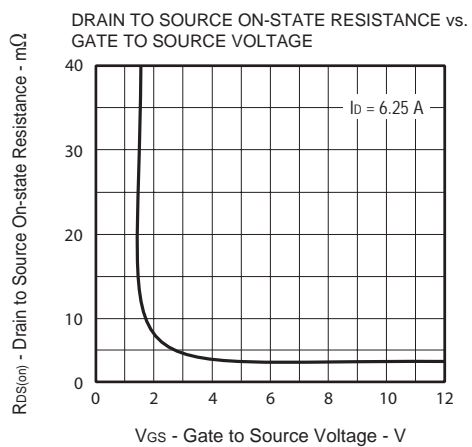
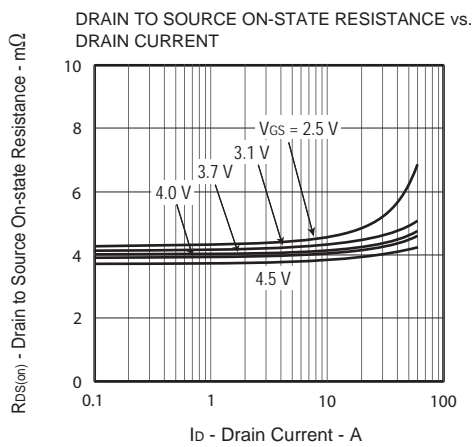
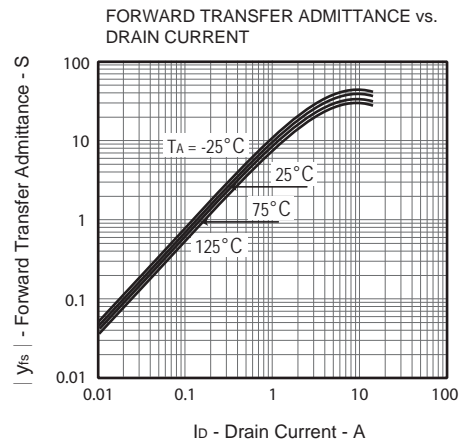
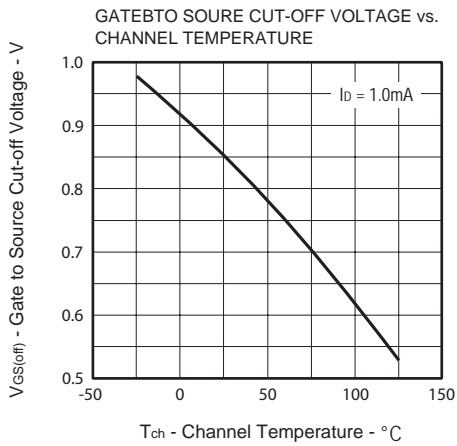
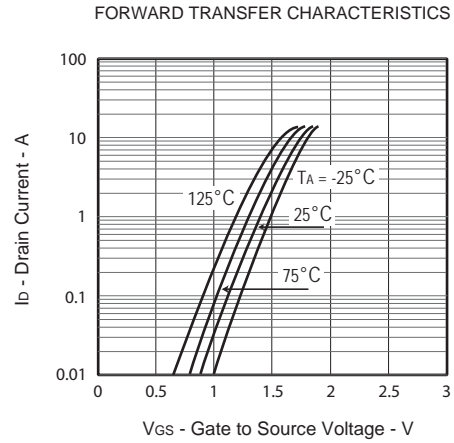
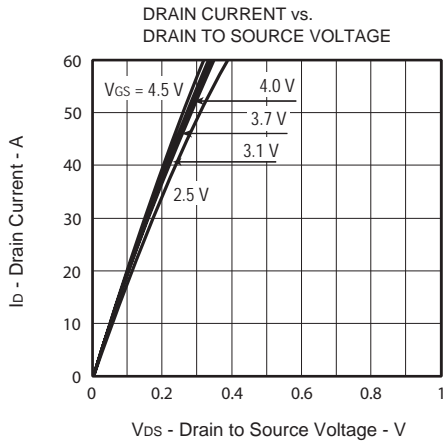

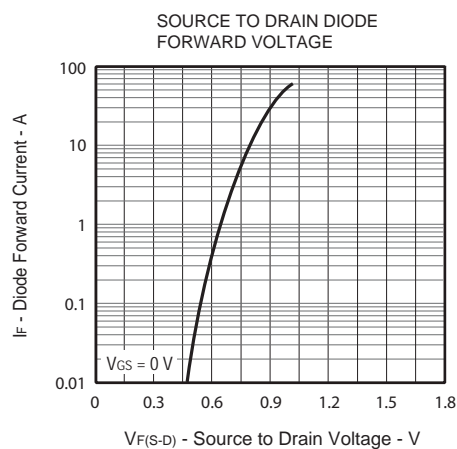
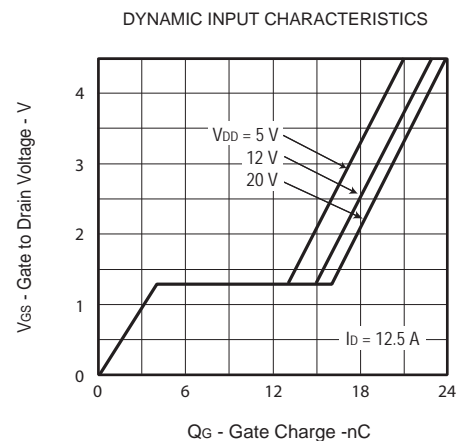
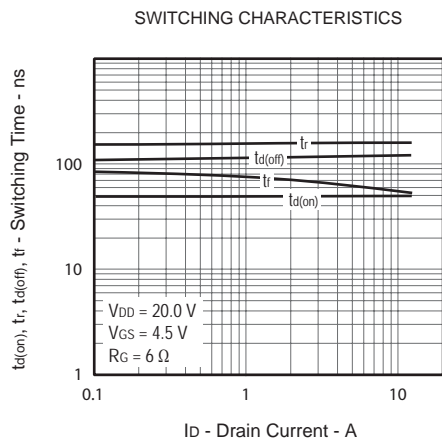
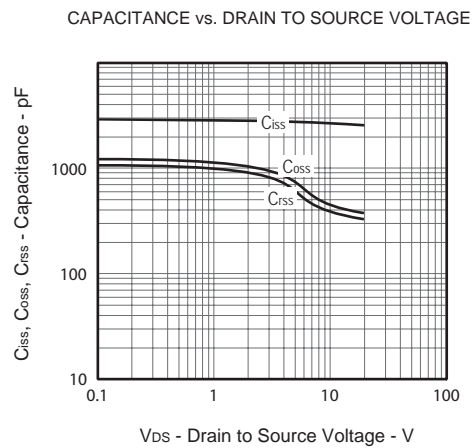
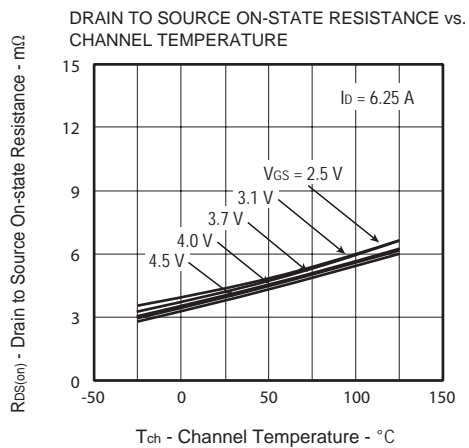

PACKAGE OUTLINE DIMENSIONS

TSON 3.3 x 3.3

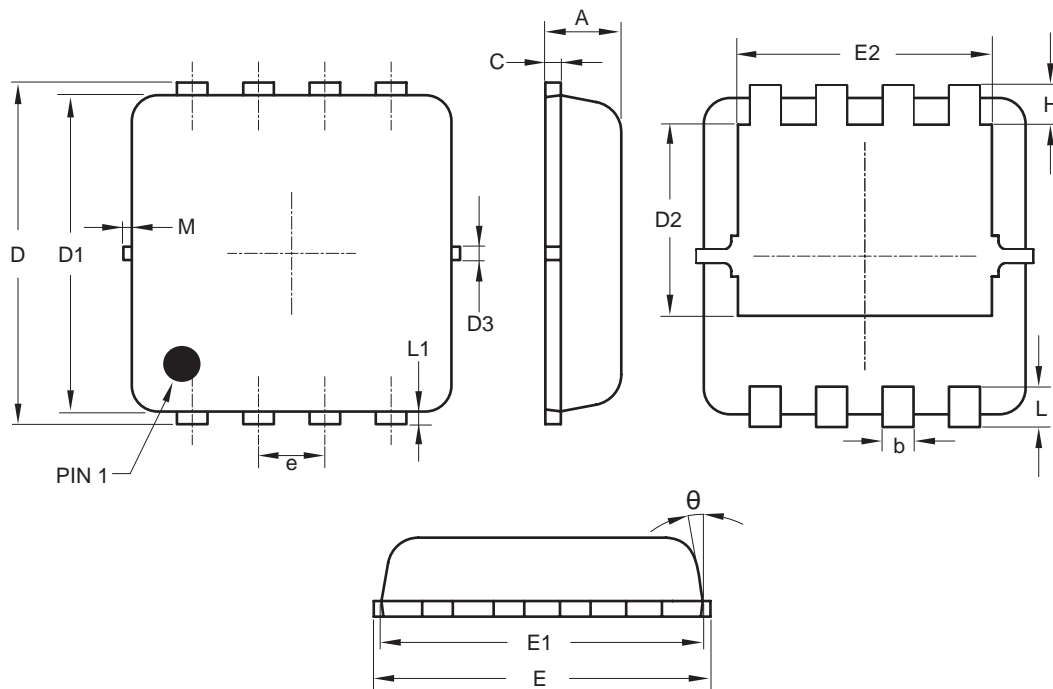

SYMBOLS	MILLIMETERS		
	MIN.	NOM.	MAX.
A	0.70	0.75	0.80
b	0.25	0.30	0.35
C	0.10	0.15	0.25
D	3.25	3.35	3.45
D1	3.00	3.10	3.20
D2	1.78	1.88	1.98
D3	—	0.13	—
E	3.20	3.30	3.40
E1	3.00	3.15	3.20
E2	2.39	2.49	2.59
e	0.65 BSC		
H	0.30	0.39	0.50
L	0.30	0.40	0.50
L1	—	0.13	—
M	—	—	0.15
θ	—	10°	12°

TSON 3.3 x 3.3 Tape and Reel Data

TSON 3.3 x 3.3 Tape

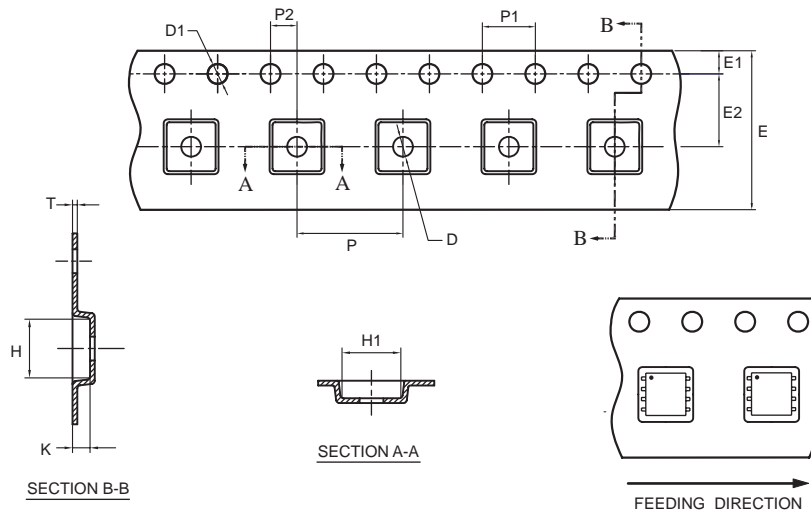

unit:mm

PACKAGE	D	D1	E	E1	E2	H	H1	K	P	P1	P2	T
S mini 8	$\phi 1.50$ (MIN)	$\phi 1.50$ +0.10 -0.00	12.0 +0.30 -0.10	1.75 ± 0.10	5.50 ± 0.05	3.70 ± 0.10	3.70 ± 0.10	1.10 ± 0.10	8.0 ± 0.10	4.0 ± 0.10	2.0 ± 0.05	0.3 ± 0.05

TSON 3.3 x 3.3 Reel

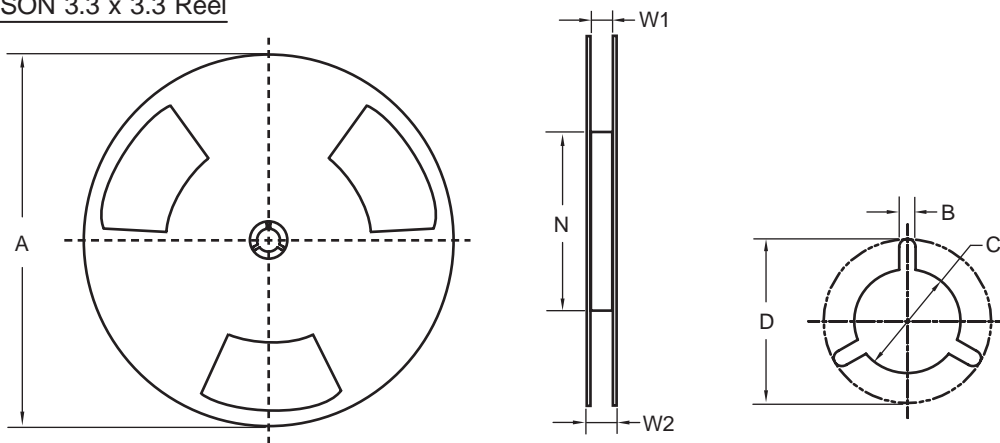

UNIT:mm

TAPE SIZE	REEL SIZE	A	B	C	D	N	W1	W2
12 mm	13 "	330 \pm 1.0	1.5 $\begin{smallmatrix} +0.5 \\ -0.2 \end{smallmatrix}$	$\phi 13.0$ $\begin{smallmatrix} +0.5 \\ -0.2 \end{smallmatrix}$	20.2(ref.)	178 $\begin{smallmatrix} +0.0 \\ -2.0 \end{smallmatrix}$	12.4 $\begin{smallmatrix} +2.0 \\ -0.0 \end{smallmatrix}$	18.4(ref.)

TOP MARKING DEFINITION

