



## N-Channel Enhancement Mode Field Effect Transistor

### PRODUCT SUMMARY

V <sub>DSS</sub>	I <sub>D</sub>	R <sub>DS(ON)</sub> (mΩ) Max
24V	27A	3.8 @ V <sub>GS</sub> =4.5V
		3.9 @ V <sub>GS</sub> =4.0V
		4.6 @ V <sub>GS</sub> =3.7V
		5.1 @ V <sub>GS</sub> =3.1V
		5.9 @ V <sub>GS</sub> =2.5V

### FEATURES

- Super high dense cell design for low R<sub>DS(ON)</sub>.
- Rugged and reliable.
- Surface Mount Package.
- ESD Protected.

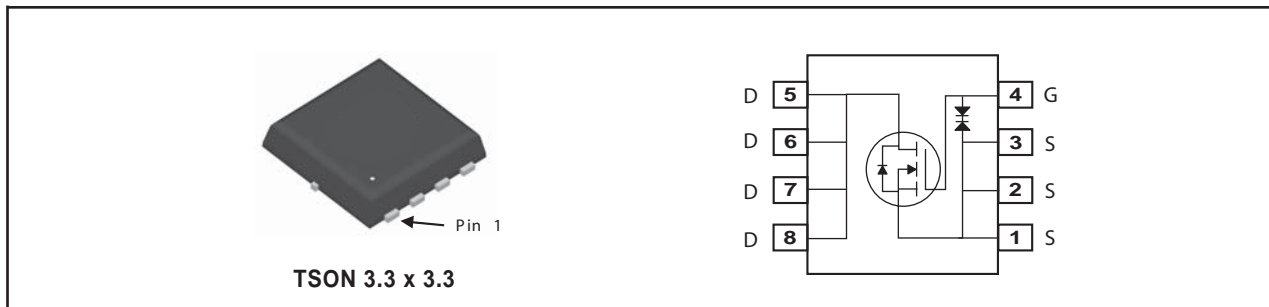

### ABSOLUTE MAXIMUM RATINGS (T<sub>A</sub>=25°C unless otherwise noted)

Symbol	Parameter	Limit	Units
V <sub>DS</sub>	Drain-Source Voltage	24	V
V <sub>GS</sub>	Gate-Source Voltage	±12	V
I <sub>D</sub>	Drain Current-Continuous <sup>a d</sup>	T <sub>A</sub> =25°C	27
		T <sub>A</sub> =70°C	21.6
I <sub>DM</sub>	-Pulsed <sup>b</sup>	81	A
P <sub>D</sub>	Maximum Power Dissipation <sup>a</sup>	T <sub>A</sub> =25°C	1.67
		T <sub>A</sub> =70°C	1.07
T <sub>J</sub> , T <sub>STG</sub>	Operating Junction and Storage Temperature Range	-55 to 150	°C

### THERMAL CHARACTERISTICS

R <sub>θJA</sub>	Thermal Resistance, Junction-to-Ambient	75	°C/W
------------------	---	----	------

# SP8007

Ver 1.0

## ELECTRICAL CHARACTERISTICS (T<sub>A</sub>=25°C unless otherwise noted)

Symbol	Parameter	Conditions	Min	Typ	Max	Units
<b>OFF CHARACTERISTICS</b>						
BV <sub>bss</sub>	Drain-Source Breakdown Voltage	V <sub>GS</sub> =0V, I <sub>D</sub> =250uA	24			V
I <sub>DSS</sub>	Zero Gate Voltage Drain Current	V <sub>DS</sub> =20V, V <sub>GS</sub> =0V			1	uA
I <sub>GSS</sub>	Gate-Body Leakage Current	V <sub>GS</sub> = ±12V, V <sub>DS</sub> =0V			±10	uA
<b>ON CHARACTERISTICS</b>						
V <sub>GS(th)</sub>	Gate Threshold Voltage	V <sub>DS</sub> =V <sub>GS</sub> , I <sub>D</sub> =1.0mA	0.5	0.9	1.5	V
R <sub>DS(ON)</sub>	Drain-Source On-State Resistance	V <sub>GS</sub> =4.5V, I <sub>D</sub> =13.5A	2.5	3.3	3.8	m ohm
		V <sub>GS</sub> =4.0V, I <sub>D</sub> =13.5A	2.6	3.4	3.9	m ohm
		V <sub>GS</sub> =3.7V, I <sub>D</sub> =13.5A	2.7	3.5	4.6	m ohm
		V <sub>GS</sub> =3.1V, I <sub>D</sub> =13.5A	2.9	3.8	5.1	m ohm
		V <sub>GS</sub> =2.5V, I <sub>D</sub> =13.5A	3.5	4.6	5.9	m ohm
g <sub>FS</sub>	Forward Transconductance	V <sub>DS</sub> =5V, I <sub>D</sub> =13.5A		34		S
<b>DYNAMIC CHARACTERISTICS <sup>c</sup></b>						
C <sub>ISS</sub>	Input Capacitance	V <sub>DS</sub> =10V, V <sub>GS</sub> =0V f=1.0MHz		2805		pF
C <sub>OSS</sub>	Output Capacitance			580		pF
C <sub>RSS</sub>	Reverse Transfer Capacitance			517		pF
<b>SWITCHING CHARACTERISTICS <sup>c</sup></b>						
t <sub>D(ON)</sub>	Turn-On Delay Time	V <sub>DD</sub> =20V I <sub>D</sub> =13.5A		68		ns
t <sub>r</sub>	Rise Time			191		ns
t <sub>D(OFF)</sub>	Turn-Off Delay Time	V <sub>GS</sub> =4.5V R <sub>GEN</sub> = 6 ohm		152		ns
t <sub>f</sub>	Fall Time			80		ns
Q <sub>g</sub>	Total Gate Charge	V <sub>DS</sub> =20V, I <sub>D</sub> =27A, V <sub>GS</sub> =4.5V		38		nC
Q <sub>gs</sub>	Gate-Source Charge			4.6		nC
Q <sub>gd</sub>	Gate-Drain Charge			20		nC
<b>DRAIN-SOURCE DIODE CHARACTERISTICS AND MAXIMUM RATINGS</b>						
V <sub>SD</sub>	Diode Forward Voltage	V <sub>GS</sub> =0V, I <sub>S</sub> =27A		0.82	1.2	V
<b>Notes</b>						
<p>a.Surface Mounted on FR4 Board,t ≤ 10sec.  b.Pulse Test:Pulse Width &lt; 10us, Duty Cycle &lt; 1%.  c.Guaranteed by design, not subject to production testing.  d.Drain current limited by maximum junction temperature.</p>						

Jul,08,2013

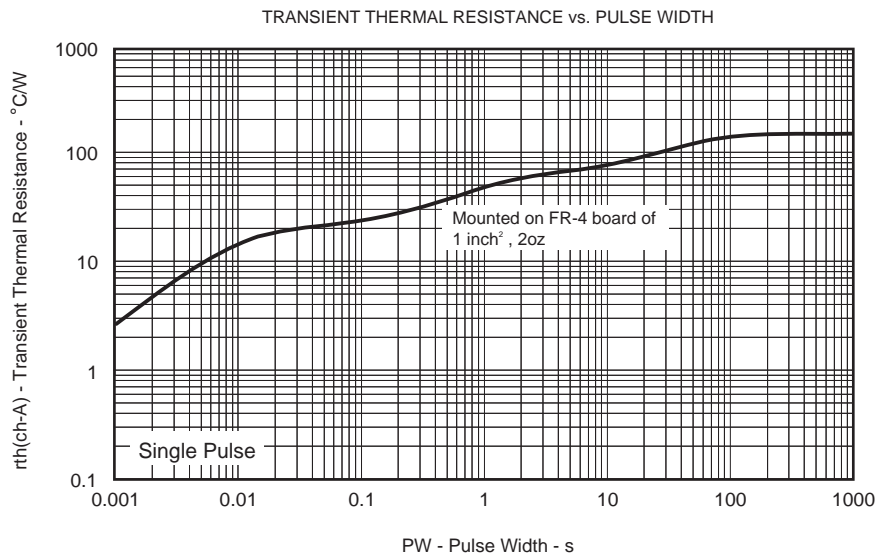
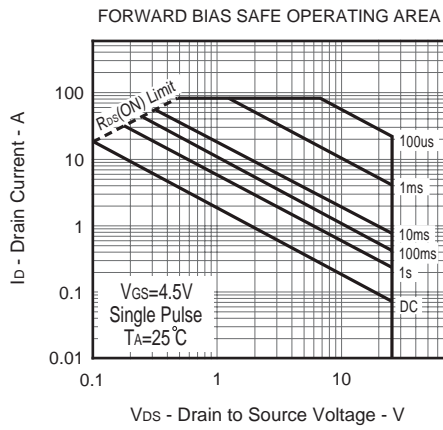
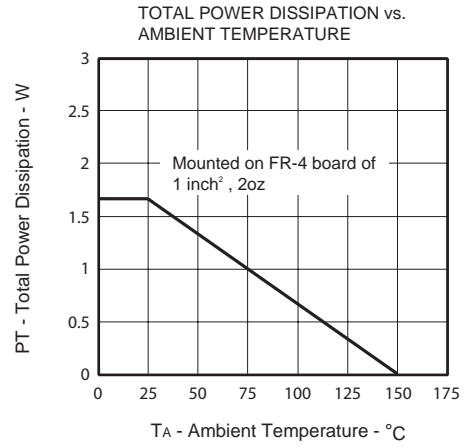
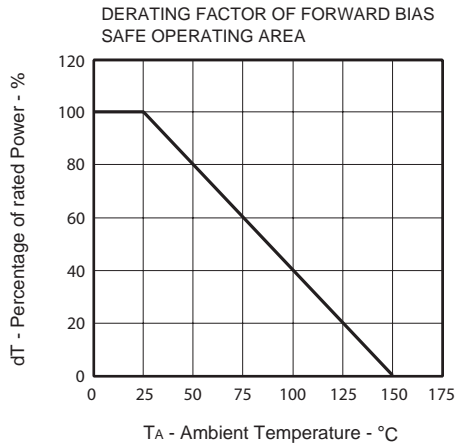

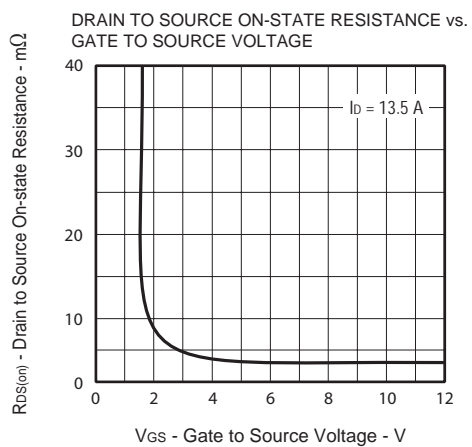
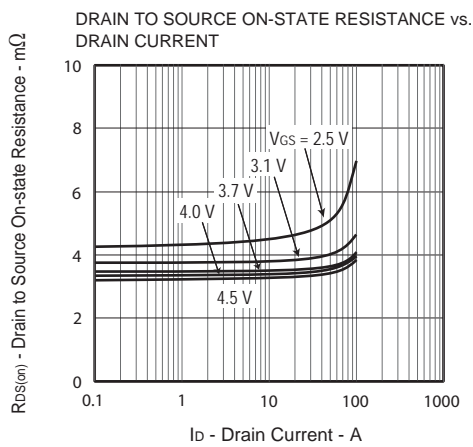
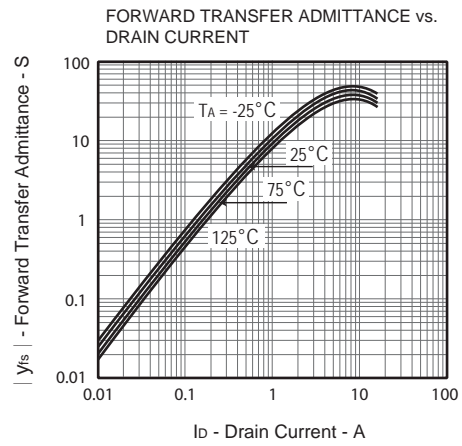
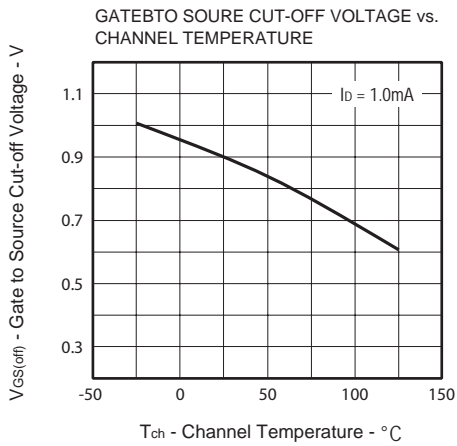
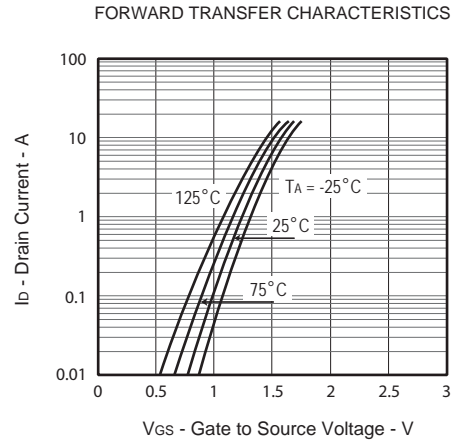
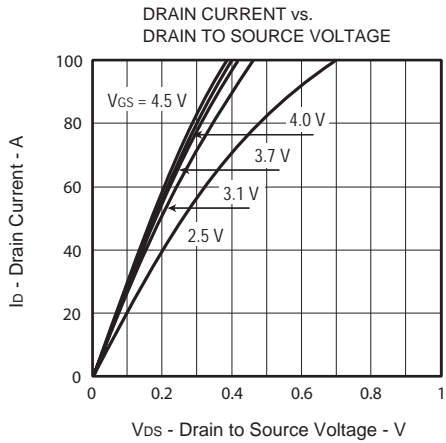

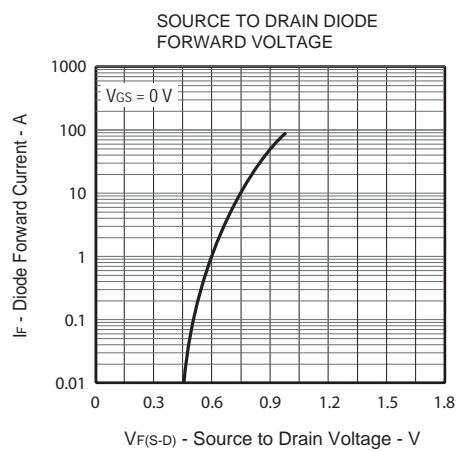
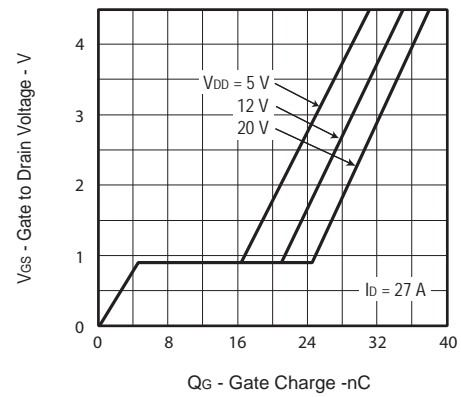
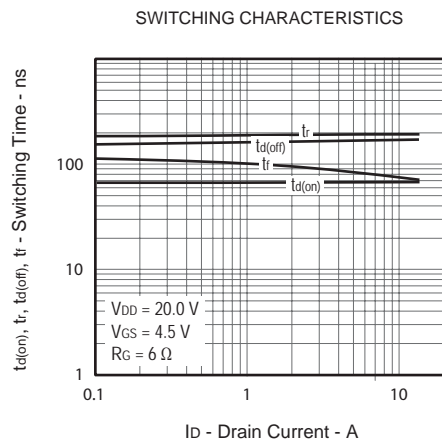
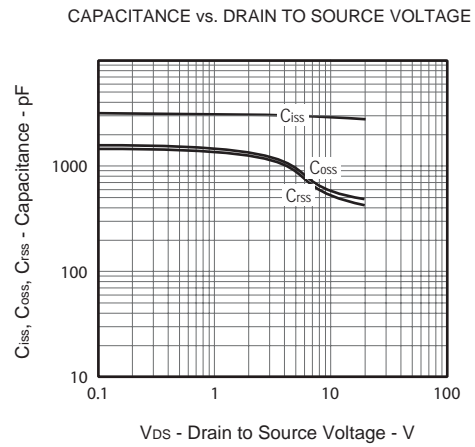
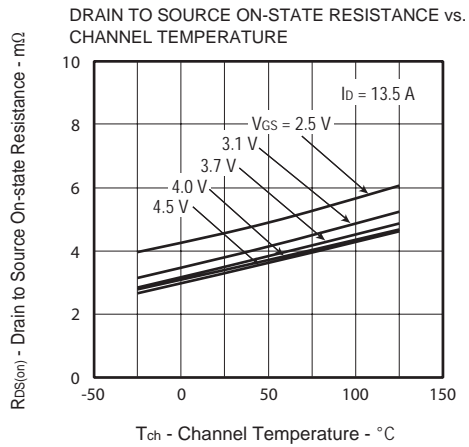

## PACKAGE OUTLINE DIMENSIONS

### TSON 3.3 x 3.3

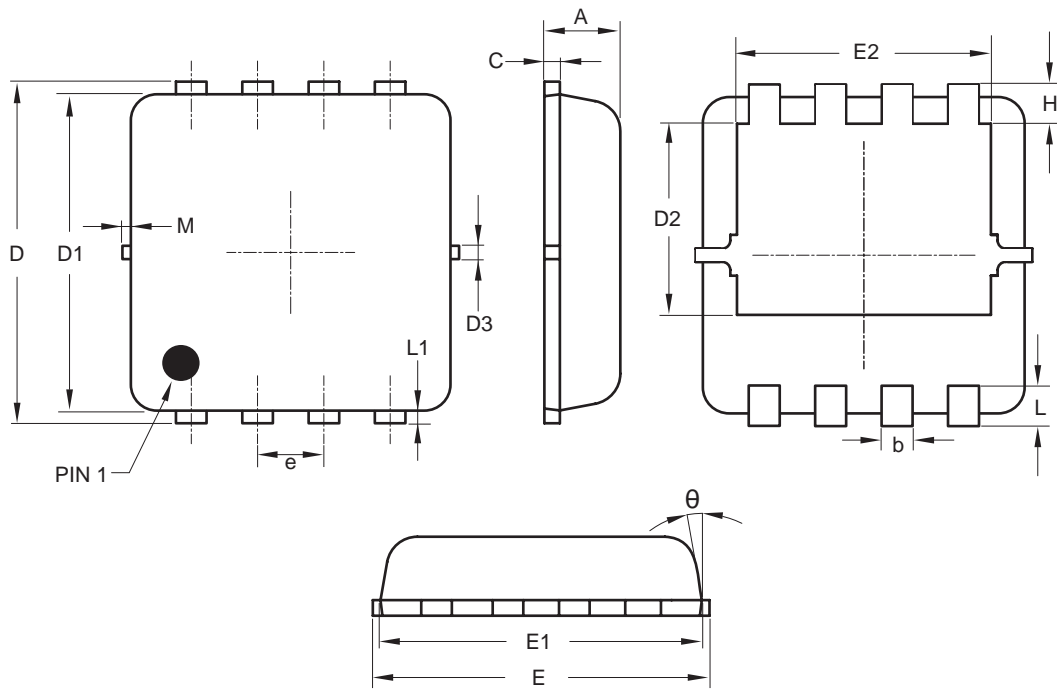

SYMBOLS	MILLIMETERS		
	MIN.	NOM.	MAX.
A	0.70	0.75	0.80
b	0.25	0.30	0.35
C	0.10	0.15	0.25
D	3.25	3.35	3.45
D1	3.00	3.10	3.20
D2	1.78	1.88	1.98
D3	—	0.13	—
E	3.20	3.30	3.40
E1	3.00	3.15	3.20
E2	2.39	2.49	2.59
e	0.65 BSC		
H	0.30	0.39	0.50
L	0.30	0.40	0.50
L1	—	0.13	—
M	—	—	0.15
θ	—	10°	12°

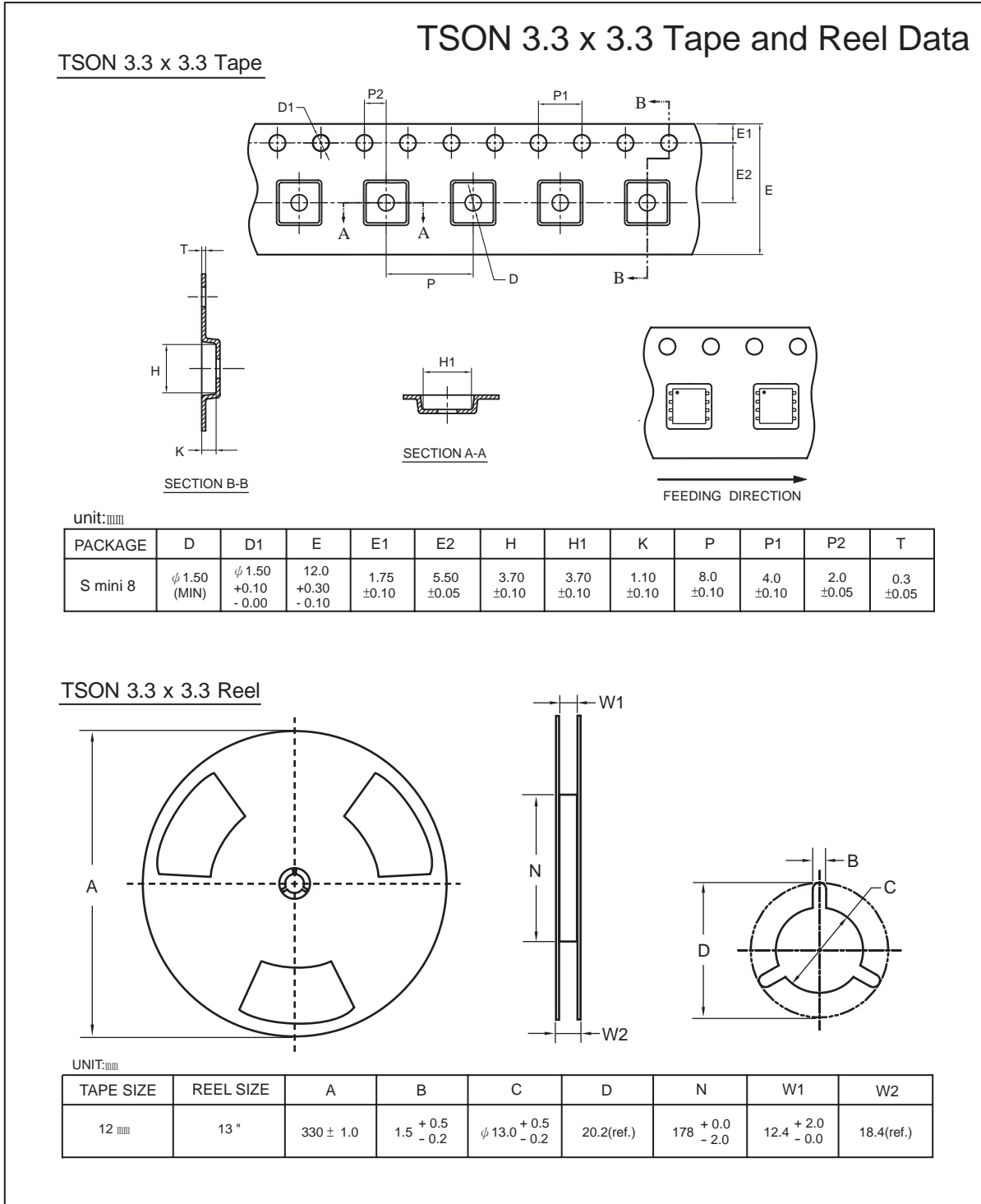

## TOP MARKING DEFINITION

