

1A Low Dropout Voltage Regulator

Fixed Output, Fast Response

FEATURES

- 1% Output Accuracy SPX3940A
- Guaranteed 1.5A Peak Current
- Low Quiescent Current
- Low Dropout Voltage of 280mV at 1A
- Extremely Tight Load and Line Regulation
- Extremely Fast Transient Response
- Reverse-battery Protection
- Internal Thermal Protection
- Internal Short Circuit Current Limit
- Replacement for LM3940
- Standard SOT-223, TO-220 and TO-263 packages

APPLICATIONS

- Powering VGA & Sound Card
- Automotive Electronics
- LCD Monitors
- Cordless Telephones
- Power PC™ Supplies

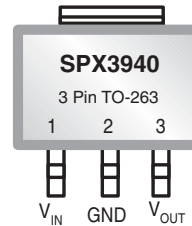

Now Available in Lead Free Packaging

- SMPS Post-Regulator
- Laptop, Palmtop, and Notebook Computer
- High Efficiency Linear Power Supplies
- Portable Instrumentation
- Constant Current Regulators

DESCRIPTION

The SPX3940 is a 1A, accurate voltage regulators with a low drop out voltage of 280mV(typical) at 1A. These regulators are specifically designed for low voltage applications that require a low dropout voltage and a fast transient response. They are fully fault protected against over-current, reverse battery, and positive and negative voltage transients.

The SPX3940 is offered in 3-pin SOT-223, TO-220 & TO-263 packages. For a 3A version, refer to the SPX29300 data sheet.

TYPICAL APPLICATIONS CIRCUIT

Figure 1. Fixed Output Linear Regulator.

ABSOLUTE MAXIMUM RATINGS

Lead Temperature (soldering, 5 seconds)	260°C
Storage Temperature Range	-65°C to +150°C
Operating Junction Temperature Range	-40°C to +125°C
Input Voltage (Note 5)	16V

ELECTRICAL CHARACTERISTICS

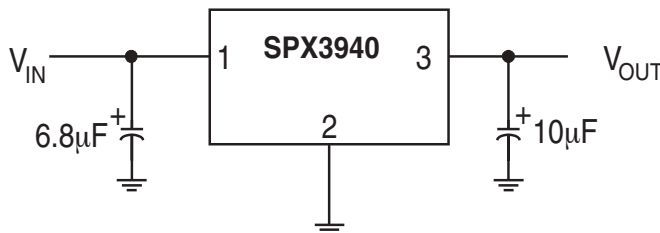
At $V_{IN} = V_{OUT} + 1V$ and $I_{OUT} = 10\text{ mA}$, $C_{IN} = 6.8\ \mu\text{F}$, $C_{OUT} = 10\ \mu\text{F}$; $T_A = 25^\circ\text{C}$, unless otherwise specified. The Boldface applies over the junction temperature range. Adjustable versions are set at 5.0V.

PARAMETER	CONDITIONS	TYP	MIN	MAX	MIN	MAX	UNITS
			SPX3940A (1%)		SP3940 (2%)		
1.8V Version							
Output Voltage	$I_{OUT} = 10\text{mA}$	1.8	1.782	1.818	1.764	1.836	V
	$10\text{mA} \leq I_{OUT} \leq 1\text{A}$, $6V \leq V_{IN} \leq 16V$	1.8	1.755	1.845	1.737	1.863	
2.5V Version							
Output Voltage	$I_{OUT} = 10\text{mA}$	2.5	2.475	2.525	2.450	2.550	V
	$10\text{mA} \leq I_{OUT} \leq 1\text{A}$, $6V \leq V_{IN} \leq 16V$	2.5	2.437	2.563	2.412	2.588	
3.3V Version							
Output Voltage	$I_{OUT} = 10\text{mA}$	3.3	3.267	3.333	3.234	3.366	V
	$10\text{mA} \leq I_{OUT} \leq 1\text{A}$, $6V \leq V_{IN} \leq 16V$	3.3	3.217	3.383	3.184	3.416	
5.0V Version							
Output Voltage	$I_{OUT} = 10\text{mA}$	5.0	4.950	5.050	4.900	5.100	V
	$10\text{mA} \leq I_{OUT} \leq 1\text{A}$, $6V \leq V_{IN} \leq 16V$	5.0	4.875	5.125	4.825	5.175	
All Voltage Options							
Line Regulation	$I_O = 10\text{mA}$, $(V_{OUT} + 1V) \leq V_{IN} \leq 16V$	0.2		1.0		1.0	%
Load Regulation	$V_{IN} = V_{OUT} + 1V$, $10\text{mA} \leq I_{OUT} \leq 1\text{A}$	0.3		1.5		1.5	%
ΔV	Output Voltage	20		100		100	ppm/°C
ΔT	Temperature Coef.						
Dropout Voltage (Note 1) (except 1.8V version)	$I_O = 100\text{mA}$	70		200		200	mV
	$I_O = 1\text{A}$	280		550		550	
Ground Current (Note 3)	$I_O = 750\text{mA}$, $V_{IN} = V_{OUT} + 1V$	12		25		25	mA
	$I_O = 1\text{A}$	18					
I_{GNDDO} Ground Pin Current at Dropout	$V_{IN} = 0.1V$ less than specified V_{OUT} $I_{OUT} = 10\text{mA}$	1.2					mA
Current Limit	$V_{OUT} = 0V$ (Note 2)	2.2	1.5		1.5		A
Output Noise Voltage (10Hz to 100kHz)	$C_L = 10\ \mu\text{F}$	400					μV_{RMS}
	$I_L = 100\text{mA}$ $C_L = 33\ \mu\text{F}$	260					
Thermal Resistance	TO-220 Junction to Case, at Tab	3					°C/W
	TO-220 Junction to Ambient	60					
	TO-263 Junction to Case, at Tab	3					°C/W
	TO-263 Junction to Ambient	60					
	SOT-223 Junction to Case, at Tab	15					°C/W
	SOT-223 Junction to Ambient	150					

NOTES:

Note 1: Dropout voltage is defined as the input to output differential when the output voltage drops to 99% of its normal value.

Note 2: $V_{IN} = V_{OUT}(\text{NOMINAL}) + 1V$. For example, use $V_{IN} = 4.3V$ for a 3.3V regulator. Employ pulse-testing procedures to minimize temperature rise.

Note 3: Ground pin current is the regulator quiescent current. The total current drawn from the source is the sum of the load current to the ground current.

Note 4: Thermal regulation is defined as the change in the output voltage at a time T after a change in power dissipation is applied, excluding load or line regulation effects.

Note 5: Maximum positive supply voltage of 20V must be of limited duration (<100ms) and duty cycle (<1%). The maximum continuous supply voltage is 16V.

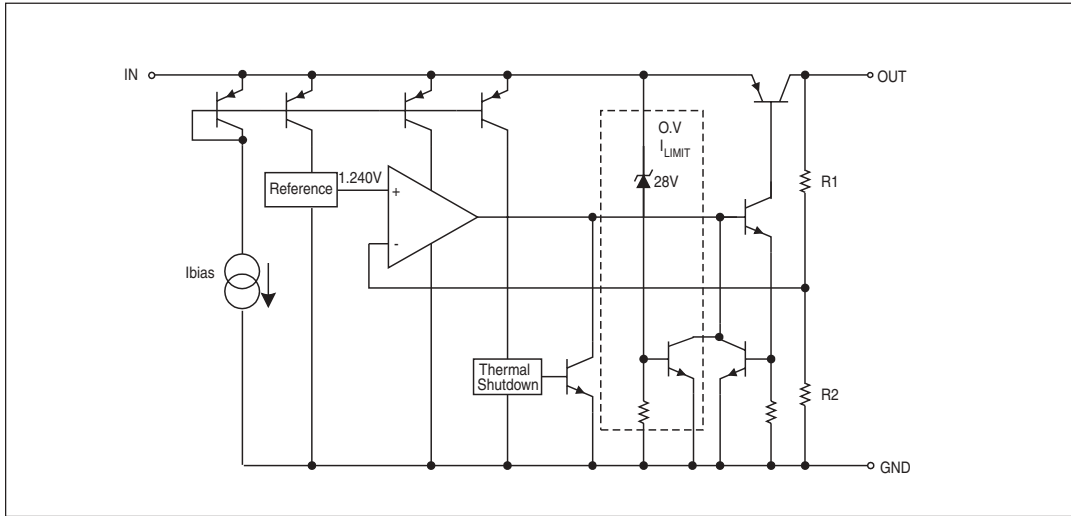

TYPICAL PERFORMANCE CHARACTERISTICS

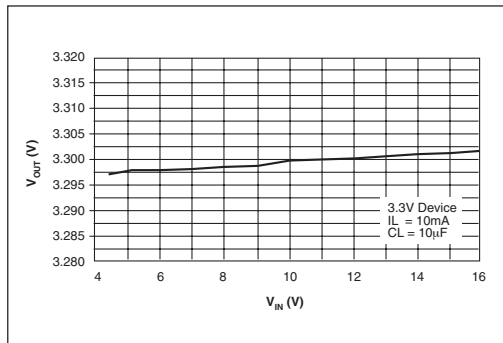

Figure 2. Line Regulation

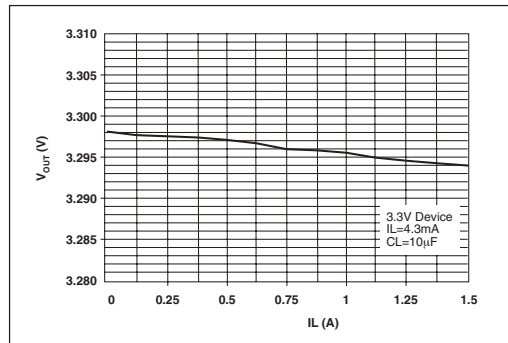

Figure 3. Load Regulation

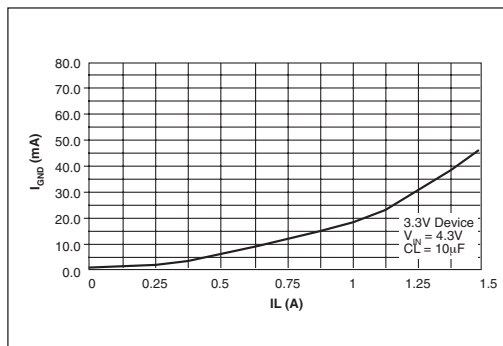

Figure 4. Ground Current vs Load Current

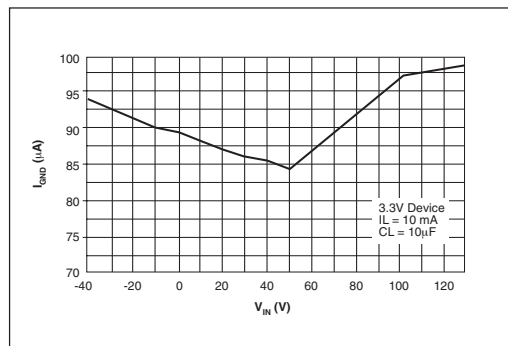

Figure 5. Ground Current vs Input Voltage

TYPICAL PERFORMANCE CHARACTERISTICS

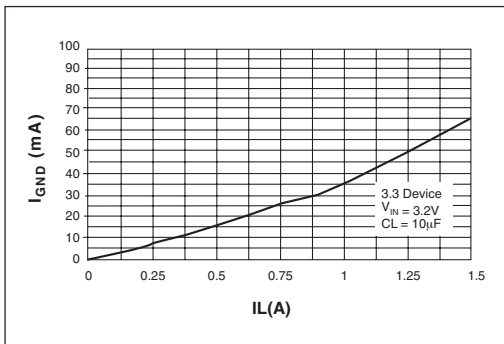

Figure 6. Ground Current vs Load Current in Dropout

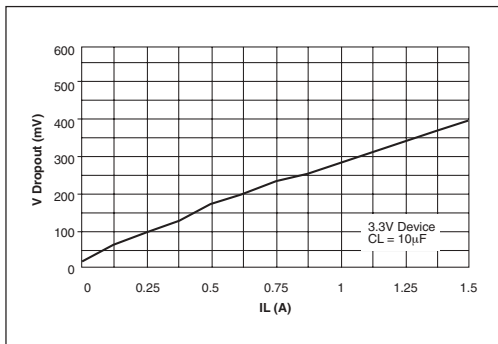

Figure 7. Dropout Voltage vs Load Current

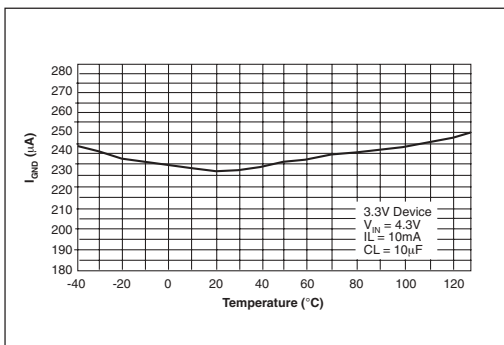

Figure 8. Ground Current vs Temperature at $I_{LOAD} = 10mA$

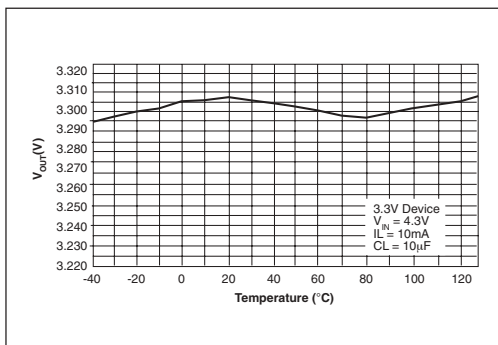

Figure 9. Output Voltage vs Temperature at $I_{LOAD} = 10mA$

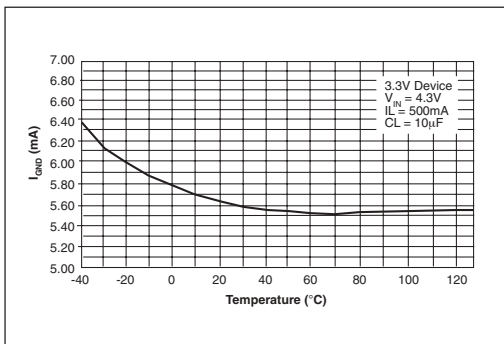

Figure 10. Ground Current vs Temperature at $I_{LOAD} = 500mA$

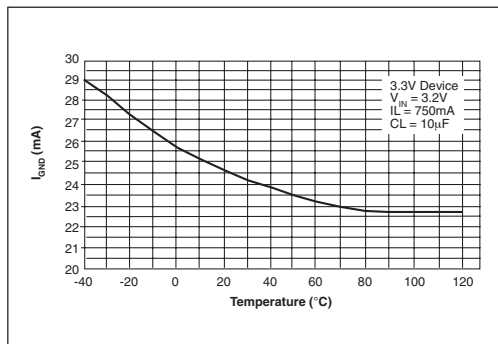

Figure 11. Ground Current vs Temperature in Dropout at $I_{LOAD} = 750mA$

TYPICAL PERFORMANCE CHARACTERISTICS

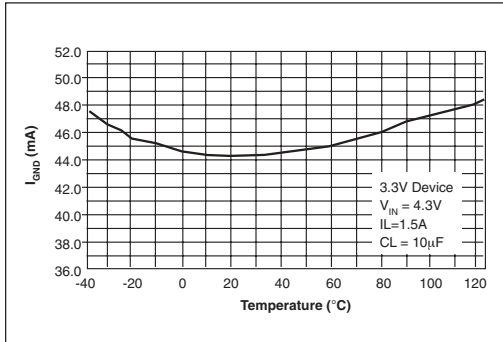

Figure 12. Ground Current vs Temperature at $I_{LOAD} = 1.5A$

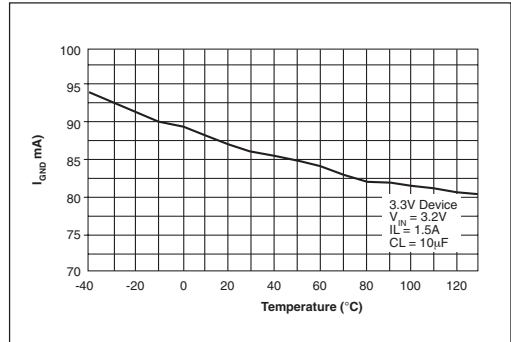

Figure 13. Ground Current vs Temperature in Dropout at $I_{LOAD} = 1.5A$

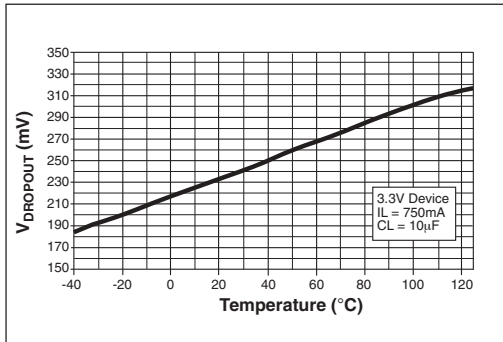

Figure 14. Dropout Voltage vs Temperature at $I_{LOAD} = 750mA$

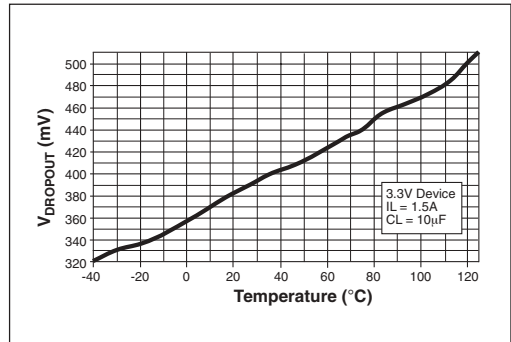

Figure 15. Dropout Voltage vs Temperature at $I_{LOAD} = 1.5mA$

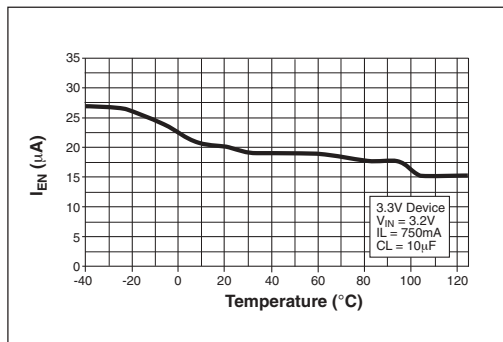

Figure 16. Enable Current vs Temperature for $V_{EN} = 16V$

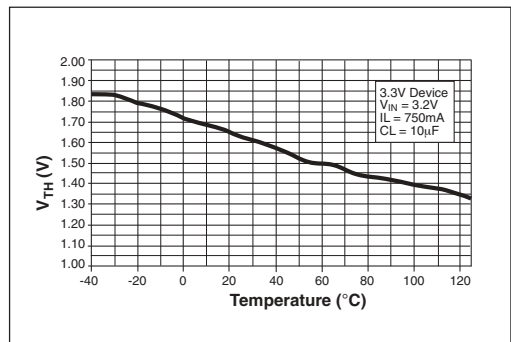

Figure 17. Enable Threshold vs Temperature

The SPX3940 incorporates protection against over-current faults, reversed load insertion, over temperature operation, and positive and negative transient voltage.

Thermal Considerations

Although the SPX3940 offers limiting circuitry for overload conditions, it is still necessary to insure that the maximum junction temperature is not exceeded in the application. Heat will flow through the lowest resistance path, the junction-to-case path. In order to insure the best thermal flow of the component, proper mounting is required. Consult heatsink manufacturer for thermal resistance and design of heatsink.

For example, TO-220 design:

Assume that $V_{IN} = 10V$, $V_{OUT} = 5V$, $I_{OUT} = 1.5A$, $T_A = 50^{\circ}C/W$, $\theta_{HA} = 1^{\circ}C/W$, $\theta_{CH} = 2^{\circ}C/W$, and $\theta_{JC} = 3^{\circ}C/W$.

Where T_A = ambient temperature

θ_{HA} = heatsink to ambient thermal resistance

θ_{CH} = case to heatsink thermal resistance

θ_{JC} = junction to case thermal resistance

The power calculated under these conditions is:

$$P_D = (V_{IN} - V_{OUT}) * I_{OUT} = 7.5W.$$

And the junction temperature is calculated as

$$T_J = T_A + P_D * (\theta_{HA} + \theta_{CH} + \theta_{JC}) \text{ or}$$

$$T_J = 50 + 7.5 * (1 + 2 + 3) = 95^{\circ}C$$

Reliable operation is insured.

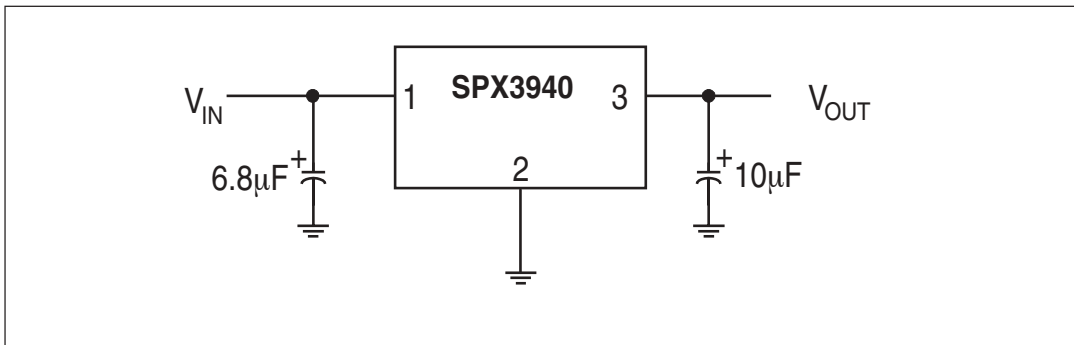

Figure 18. Fixed Output Linear Regulator.

Capacitor Requirements

The output capacitor is needed to insure stability and minimize the output noise. The value of the capacitor varies with the load. However, a minimum value of 10µF aluminum capacitor will guarantee stability over all load conditions. A tantalum capacitor is recommended if a faster load transient response is needed.

If the power source has a high AC impedance, a 0.1µF ceramic capacitor between input & ground is recommended.

Minimum Load Current

To ensure a proper behavior of the regulator under light load, a minimum load of 5mA for SPX3940 is required.

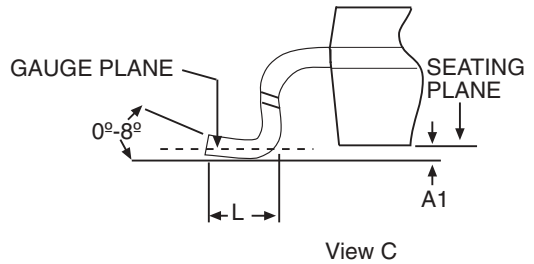
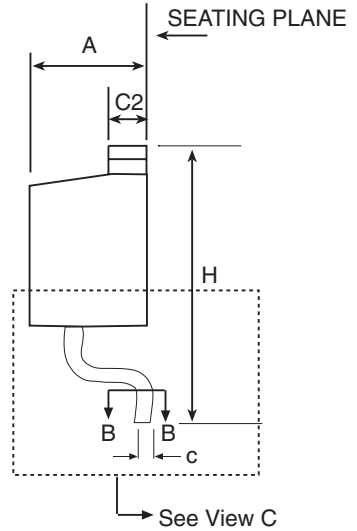
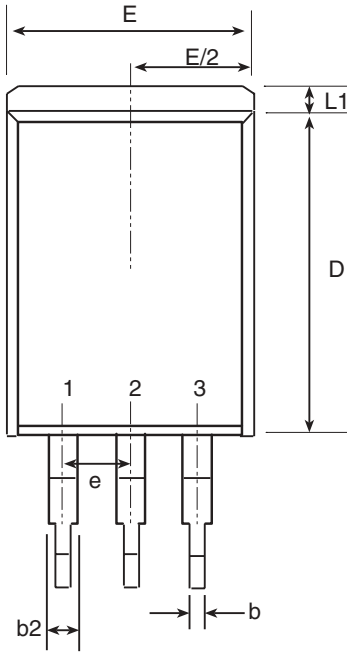

3-PIN TO-263 JEDEC TO-263 (AA) Variation	Dimensions in inches		
	MIN	NOM	MAX
A	.160	-	.190
A1	.000	-	.010
b	.020	-	.039
c	.015	-	.029
D	.330	-	.380
D1	.270	-	-
E	.380	-	.420
E1	.245	-	-
e	.100 BSC		
H	.575	-	.625
L	.070	-	.110
L1	-	-	.066
L2	-	-	.070
L3	.010 BSC		

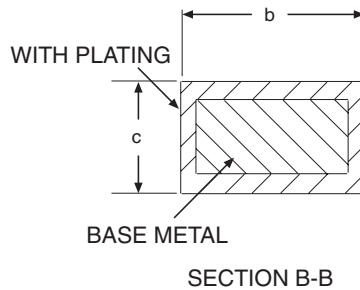

3 PIN TO-263

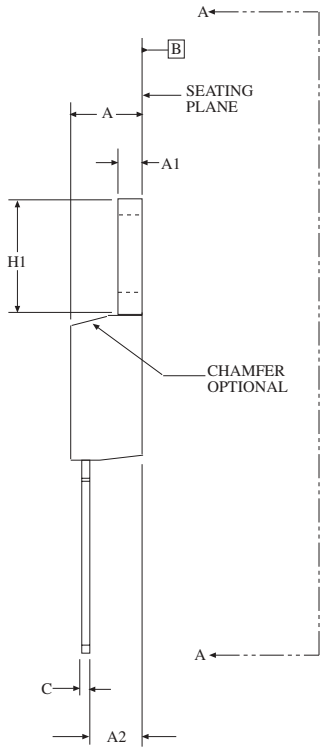
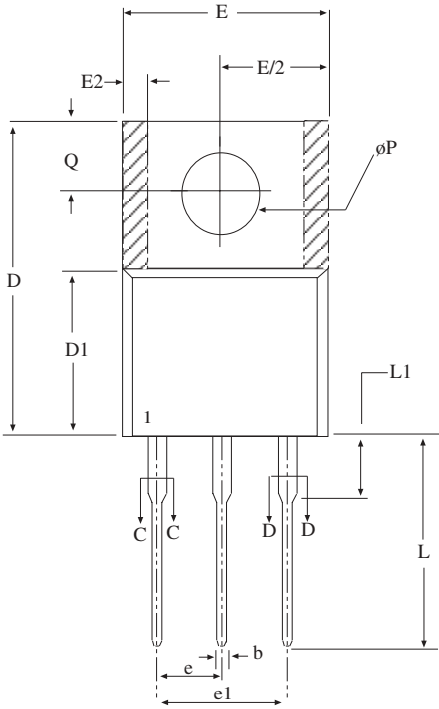

Dimensions in (mm)	3 PIN TO-220 JEDEC TO-220 (AB) Variation		
	MIN	NOM	MAX
A	.140	-	.190
A1	.020	-	.055
A2	.080	-	.115
b	.015	.027	.040
b2	.045	-	.070
c	.014	-	.024
D	.560	-	.650
D1	.330	-	.355
D2	.480	-	.507
E	.380	-	.420
E1	.270	-	.350
E2	-	-	.030
e	.100 BSC		
e1	.200 BSC		
H1	.230	-	.270
L1	-	-	.250
L2	-	-	-
ΔP	.139	-	.161
Q	.100	-	.135

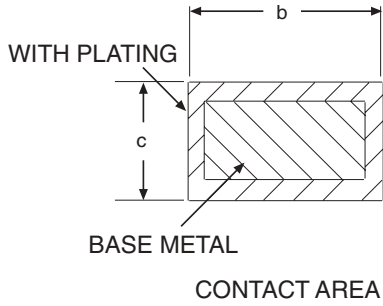

3 PIN TO-220

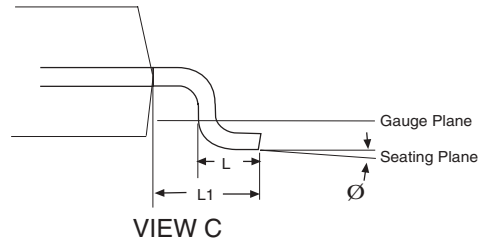
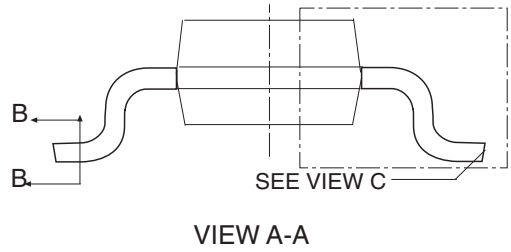
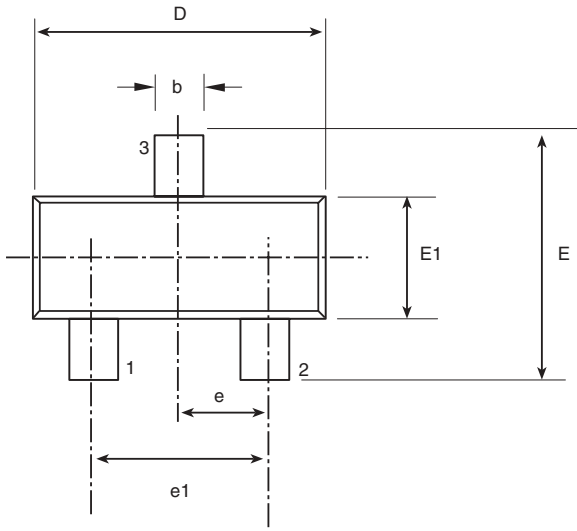

3 PIN SOT-23 JEDEC TO-236 (AB) Variation	Dimensions in (mm)		
	MIN	NOM	MAX
A	0.89	-	1.12
A1	0.01	-	0.10
A2	0.88	0.95	1.02
b	0.30	-	0.50
c	0.08	-	0.20
D	2.80	2.90	3.04
e	0.95 BSC		
e1	1.90 BSC		
E	2.10	-	2.64
E1	1.20	1.30	1.40
L	0.40	0.50	0.60
L1	0.54 REF		
Ø	0°	-	8°

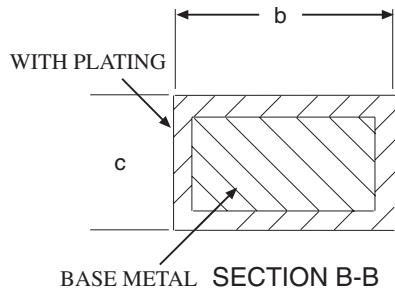
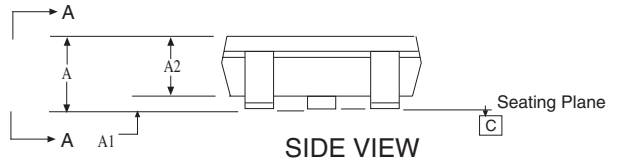

3 PIN SOT-23

TO-263-3 Package (T)

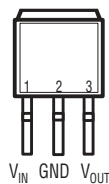
Front View
TAB=GND

TO-220-3 Package (U)

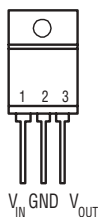
Front View
TAB=GND

SOT-223 (M3)

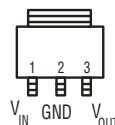
Top View
TAB=GND

ORDERING INFORMATION

PART NUMBER	ACC.	OUTPUT VOLTAGE	PACKAGE
SPX3940AU-1.8	1%	1.8V	3 lead TO-220
SPX3940AU-2.5	1%	2.5V	3 lead TO-220
SPX3940AU-3.3	1%	3.3V	3 lead TO-220
SPX3940AU-5.0	1%	5.0V	3 lead TO-220
SPX3940AT-1.8	1%	1.8V	3 lead TO-263
SPX3940AT-1.8/TR	1%	1.8V	3 lead TO-263
SPX3940AT-2.5	1%	2.5V	3 lead TO-263
SPX3940AT-2.5/TR	1%	2.5V	3 lead TO-263
SPX3940AT-3.3	1%	3.3V	3 lead TO-263
SPX3940AT-3.3/TR	1%	3.3V	3 lead TO-263
SPX3940AT-5.0	1%	5.0V	3 lead TO-263
SPX3940AT-5.0/TR	1%	5.0V	3 lead TO-263
SPX3940U-1.8	2%	1.8V	3 lead TO-220
SPX3940U-2.5	2%	2.5V	3 lead TO-220
SPX3940U-3.3	2%	3.3V	3 lead TO-220
SPX3940U-5.0	2%	5.0V	3 lead TO-220

Available in lead free packaging. To order add "-L" suffix to part number.

Example: SPX3940AT-3.3/TR = standard; SPX3940AT-L-3.3/TR = lead free

/TR = Tape and Reel

Pack quantity is 500 for TO-263 and 2,500 for SOT-23.



ANALOG EXCELLENCE

Sipex Corporation

Headquarters and
Sales Office

233 South Hillview Drive
Milpitas, CA 95035
TEL: (408) 934-7500
FAX: (408) 935-7600

Sipex Corporation reserves the right to make changes to any products described herein. Sipex does not assume any liability arising out of the application or use of any product or circuit described herein; neither does it convey any license under its patent rights nor the rights of others.

PART NUMBER	ACC.	OUTPUT VOLTAGE	PACKAGE
SPX3940T-1.8	2%	1.8V	3 lead TO-263
SPX3940T-1.8/TR	2%	1.8V	3 lead TO-263
SPX3940T-2.5	2%	2.5V	3 lead TO-263
SPX3940T-2.5/TR	2%	2.5V	3 lead TO-263
SPX3940T-3.3	2%	3.3V	3 lead TO-263
SPX3940T-3.3/TR	2%	3.3V	3 lead TO-263
SPX3940T-5.0	2%	5.0V	3 lead TO-263
SPX3940T-5.0/TR	2%	5.0V	3 lead TO-263
SPX3940AM3-1.8	1%	1.8V	3 lead SOT-223
SPX3940AM3-1.8/TR	1%	1.8V	3 lead SOT-223
SPX3940AM3-2.5	1%	2.5V	3 lead SOT-223
SPX3940AM3-2.5/TR	1%	2.5V	3 lead SOT-223
SPX3940AM3-3.3	1%	3.3V	3 lead SOT-223
SPX3940AM3-3.3/TR	1%	3.3V	3 lead SOT-223
SPX3940AM3-5.0	1%	5.0V	3 lead SOT-223
SPX3940AM3-5.0/TR	1%	5.0V	3 lead SOT-223
SPX3940M3-1.8	2%	1.8V	3 lead SOT-223
SPX3940M3-1.8/TR	2%	1.8V	3 lead SOT-223
SPX3940M3-2.5	2%	2.5V	3 lead SOT-223
SPX3940M3-2.5/TR	2%	2.5V	3 lead SOT-223
SPX3940M3-3.3	2%	3.3V	3 lead SOT-223
SPX3940M3-3.3/TR	2%	3.3V	3 lead SOT-223
SPX3940M3-5.0	2%	5.0V	3 lead SOT-223
SPX3940M3-5.0/TR	2%	5.0V	3 lead SOT-223

Available in lead free packaging. To order add "-L" suffix to part number.

Example: SPX3940AM3-3.3/TR = standard; SPX3940AM3-L-3.3/TR = lead free

/TR = Tape and Reel

Pack quantity is 500 for TO-263 and 2,500 for SOT-23.



ANALOG EXCELLENCE

Sipex Corporation

**Headquarters and
Sales Office**
233 South Hillview Drive
Milpitas, CA 95035
TEL: (408) 934-7500
FAX: (408) 935-7600