

RoHS Compliant Product

A suffix of "-C" specifies halogen & lead-free



FEATURES

- * Low forward voltage drop
- * High current capability
- * High reliability
- * High surge current capability
- * Epitaxial construction

MECHANICAL DATA

- * Case: Molded plastic
- * Epoxy: UL 94V-0 rate flame retardant
- * Lead: Lead solderable per MIL-STD-202, method 208 guaranteed
- * Polarity: As Marked
- * Mounting position: Any
- * Weight: 2.24 grams(Approximately)

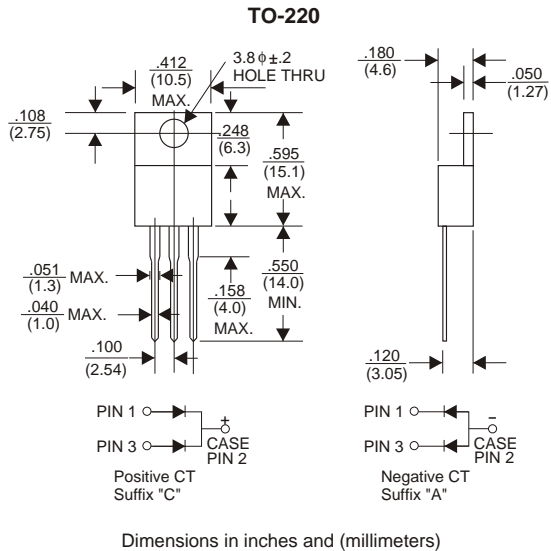

MAXIMUM RATINGS AND ELECTRICAL CHARACTERISTICS

Rating 25°C ambient temperature unless otherwise specified.
Single phase half wave, 60Hz, resistive or inductive load.
For capacitive load, derate current by 20%.

TYPE NUMBER	SR10200	UNITS
Maximum Recurrent Peak Reverse Voltage	200	V
Working Peak Reverse Voltage	200	V
Maximum DC Blocking Voltage	200	V
Maximum Average Forward Rectified Current	10	A
See Fig. 1		
Peak Forward Surge Current, 8.3 ms single half sine-wave superimposed on rated load (JEDEC method)	120	A
Maximum Instantaneous Forward Voltage (I _F = 5 Amps, T _F = 25 °C)	0.92	V
Maximum Instantaneous Forward Voltage (I _F = 5 Amps, T _F = 125 °C)	0.75	V
Maximum DC Reverse Current T _a =25°C	0.02	mA
at Rated DC Blocking Voltage T _a =125°C	10	mA
Typical Junction Capacitance (Note 1)	350	pF
Typical Thermal Resistance R _{θJA} (Note 2)	2.0	°C/W
Operating Temperature Range T _J	-50 ~ +150	°C
Storage Temperature Range T _{STG}	-65 ~ +175	°C

NOTES:

1. Measured at 1MHz and applied reverse voltage of 5.0V D.C.
2. Thermal Resistance Junction to Case.

RATING AND CHARACTERISTIC CURVES (SR10200)

FIG.1-TYPICAL FORWARD CURRENT DERATING CURVE

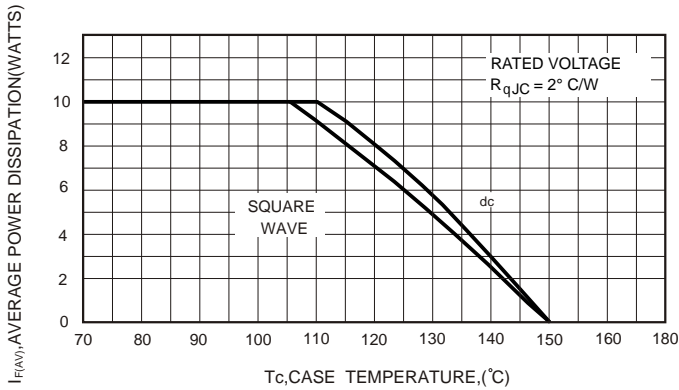

FIG.2- TYPICAL FORWARD VOLTAGE (PER LEG)

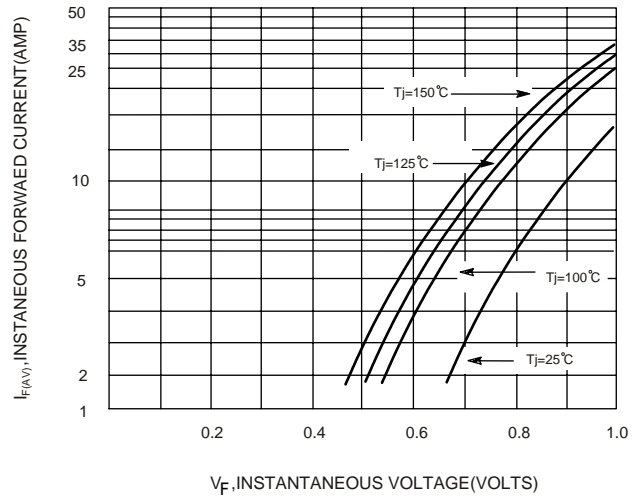

FIG.3-MAXIMUM NON-REPETITIVE FORWARD SURGE CURRENT

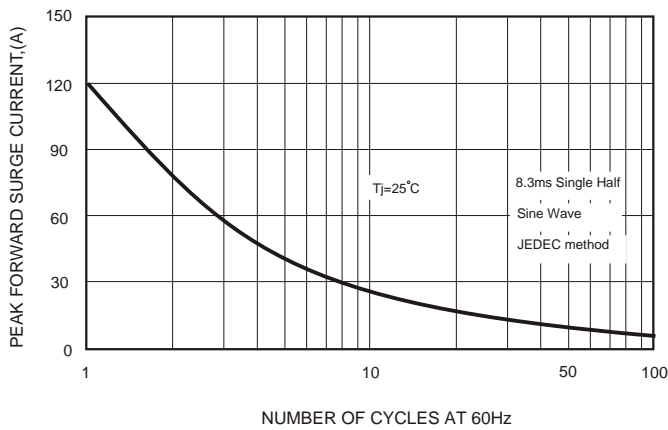

FIG.5-TYPICAL REVERSE CURRENT (PER LEG)

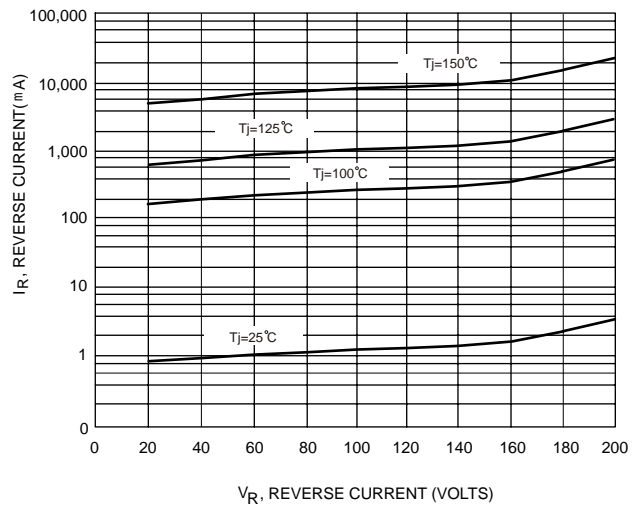

FIG.4-TYPICAL JUNCTION CAPACITANCE

