

FEATURES

- Power pack
- Metal silicon junction ,majority carrier conduction
- Guard ring for overvoltage protection
- Low power loss ,high efficiency
- High current capability ,low forward voltage drop
- High forward surge capability
- High frequency operation
- Solder dip 275°C maximum,10s,per JESD22-B106
- Component in accordance to RoHS 2011/65/EU



RoHS
COMPLIANT

TO-220AC

SR16100L



ITO-220AC

SRF16100L



Dimensions in inches and (millimeters)

MECHANICAL DATA

- Case: JEDEC TO-220AC、ITO-220AC
- Molding compound meets UL94V-0 flammability rating
- Terminals: Lead solderable per J-STD-002 and JESD22-B102
- Polarity: As marked
- Mounting Torque: 10 in-lbs maximum

TYPICAL APPLICATIONS

For use in low voltage ,high frequency inverters ,DC/DC converters, free wheeling ,and polarity protection applications

PRIMARY CHARACTERISTICS

IF(AV)	16A
VRRM	100V
IFSM	200A
VF at IF=16.0A(125°C)	0.63V
IR	20 μ A
TJ(MAX)	150°C
Package	TO-220AC, ITO-220AC
Diode variations	Single

MAXIMUM RATINGS

(Ratings at 25°C ambient temperature unless otherwise specified)

Parameter	Symbol	SR16100L, SRF16100L	Unit
Maximum repetitive peak reverse voltage	VRRM	100	V
Maximum average forward rectified current (see fig.1)	IF(AV)	16.0	A
Peak forward surge current 8.3ms single half sine-wave superimposed on rated load (JEDEC method at rated TL)	IFSM	200	A
Peak repetitive reverse current per diode at tp=2 μ s 1KHz	IRRM	0.5	A
Operating junction and Storage temperature range	TJ, Tstg	-55 to+150	°C
Isolation voltage (ITO-220AB only) from terminals to heatsink t=1 min	VAC	1500	V

RATINGS AND CHARACTERISTIC OF SR16100L,SRF16100L

ELECTRICAL CHARACTERISTICS (T_A=25°C Unless otherwise noted)

Parameter	Test Conditions		Symbol	TYP.	MAX.	Unit
Instantaneous forward voltage	I _F =16.0A	T _A =25°C	V _F ¹⁾	0.66	0.70	V
		T _A =100°C		0.64	—	
		T _A =125°C		0.63	—	
	I _F =8.0A	T _A =25°C		0.53	0.59	
		T _A =100°C		0.51	—	
		T _A =125°C		0.50	—	
Reverse current	V _R =100V	T _A =25°C	I _R ²⁾	20	50	μA
		T _A =100°C		2	5	mA
		T _A =125°C		10	20	
Typical junction capacitance	4V, 1MHz		C _J	570		pF

Notes: 1.Pulse test: 300 μs pulse width,1% duty cycle

2.Pulse test: pulse width≤40ms

THERMAL CHARACTERISTICS (T_A=25°C Unless otherwise noted)

Parameter	Symbol	SR16100L	SRF16100L	Unit
Typical thermal resistance ³⁾	R _{θJC}	2.5	4.5	°C/W

3.Thermal resistance from junction to case

AVAILABLE PACK INFORMATION

Product code	Pack	Box Size L×W×H(mm)	Quantity (pcs/box)	Carton SizeL×W×H(mm)	Quantity (box/carton)
SR16100L-TO-220AC	P/T	558×148×38	1000	565×225×170	5
SRF16100L-ITO-220AC	P/T	558×148×38	1000	565×225×170	5

RATINGS AND CHARACTERISTIC OF SR16100L,SRF16100L

FIG.1-FORWARD CURRENT DERATING CURVE

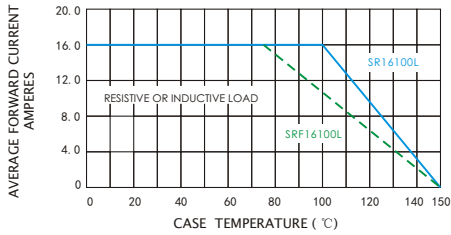

FIG.2-MAXIMUM NON-REPETITIVE PEAK FORWARD SURGE CURRENT

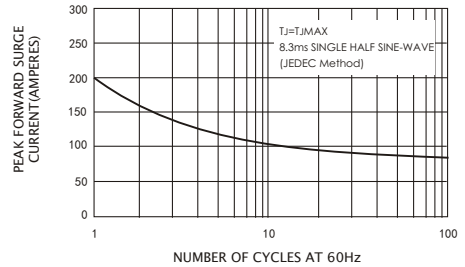

FIG.3-TYPICAL INSTANTANEOUS FORWARD CHARACTERISTICS

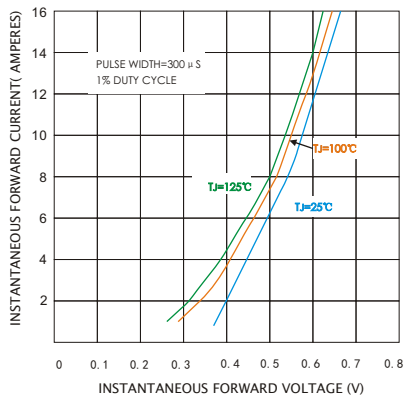

FIG.4-TYPICAL REVERSE CHARACTERISTICS

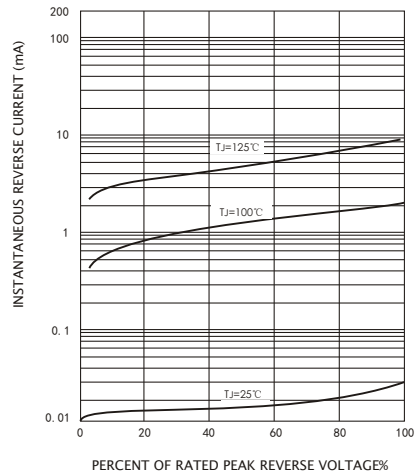
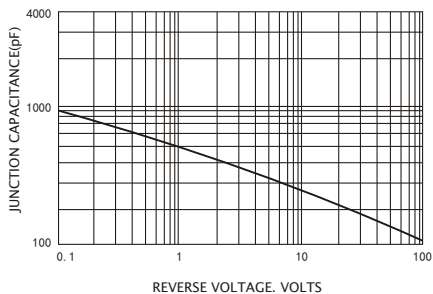
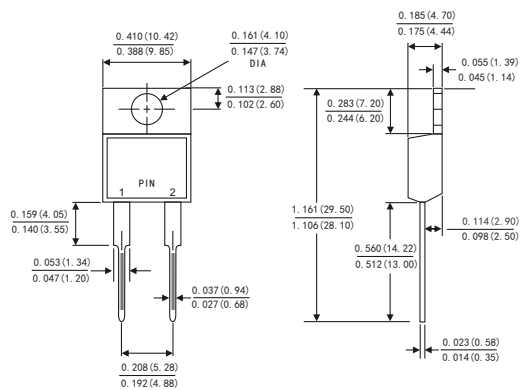

FIG.5-TYPICAL JUNCTION CAPACITANCE



PACKAGE OUTLINE DIMENSIONS

TO-220AC



ITO-220AC

