

SR220 THRU SR2200

List

List..... 1

Package outline..... 2

Features..... 2

Mechanical data..... 2

Maximum ratings 2

Rating and characteristic curves..... 3

Pinning information..... 4

Marking..... 4

Taping & bulk specifications for AXIAL devices..... 4

Suggested thermal profiles for soldering processes..... 5

High reliability test capabilities..... 6

深圳FMS Kinter 131 6803 0058

SR220 THRU SR2200

2.0A Axial Leaded Schottky Barrier Rectifiers-20V-200V

Features

- Metal silicon junction ,majority carrier conduction
- Guard ring for overvoltage protection
- Low power loss ,high efficiency
- High current capability ,Low forward voltage drop
- High surge capability
- For use in low voltage ,high frequency inverters, free wheeling ,and polarity protection applications
- High temperature soldering guaranteed:260°C/10 seconds at terminals
- Lead-free parts meet environmental standards of MIL-STD-19500 /228
- Suffix "-H" indicates Halogen-free parts, ex. SR220-H.

Mechanical data

- Epoxy : UL94-V0 rated flame retardant
- Case : Molded plastic, DO-41
- Lead : Axial leads, solderable per MIL-STD-202, Method 208 guaranteed
- Polarity: Color band denotes cathode end
- Mounting Position : Any
- Weight : Approximated 0.33 gram

Package outline

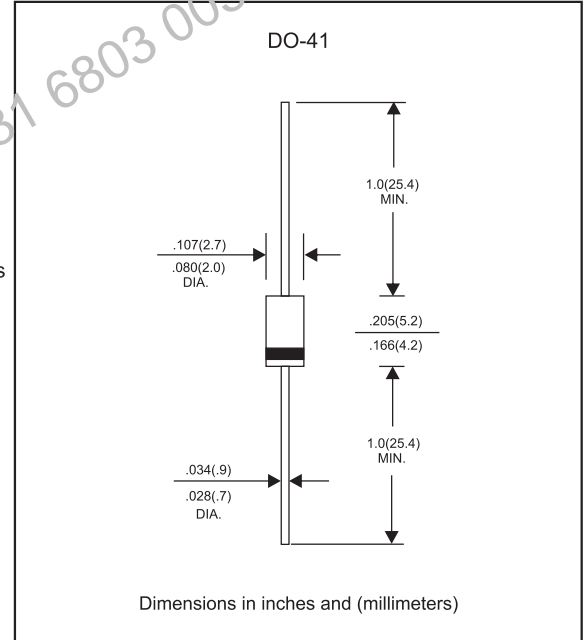

Maximum ratings and Electrical Characteristics (AT T_A=25°C unless otherwise noted)

PARAMETER	CONDITIONS	Symbol	MIN.	TYP.	MAX.	UNIT
Forward rectified current	See Fig.2	I _O			2.0	A
Forward surge current	8.3ms single half sine-wave superimposed on rate load (JEDEC methode)	I _{FSM}			50	A
Reverse current	V _R = V _{RRM} T _J = 25°C	I _R			0.5	mA
	Junction to ambient Note 1				10	
Thermal resistance	Junction to ambient	R _{θJA}		50		°C/W
Diode junction capacitance	f=1MHz and applied 4V DC reverse voltage	C _J		170		pF
Storage temperature		T _{STG}	-65		+175	°C

Note 1: Thermal resistance from junction to lead, and/or to ambient P. C. B. mounted with 0.375" (9.5mm) lead length with 1.5 X1.5"(38X38mm)copper pads

SYMBOLS	V _{RRM} ^{*1} (V)	V _{RMS} ^{*2} (V)	V _R ^{*3} (V)	V _F ^{*4} (V)	Operating temperature T _J , (°C)
SR220	20	14	20	0.55	-55 to +125
SR230	30	21	30		
SR240	40	28	40		
SR250	50	35	50	0.70	-55 to +150
SR260	60	42	60		
SR280	80	56	80	0.85	
SR2100	100	70	100		
SR2150	150	105	150	0.90	
SR2200	200	140	200	0.95	

*1 Repetitive peak reverse voltage

*2 RMS voltage

*3 Continuous reverse voltage

*4 Maximum forward voltage@I_F=2.0A

Rating and characteristic curves (SR220 THRU SR2200)

FIG.1-TYPICAL FORWARD CURRENT DERATING CURVE

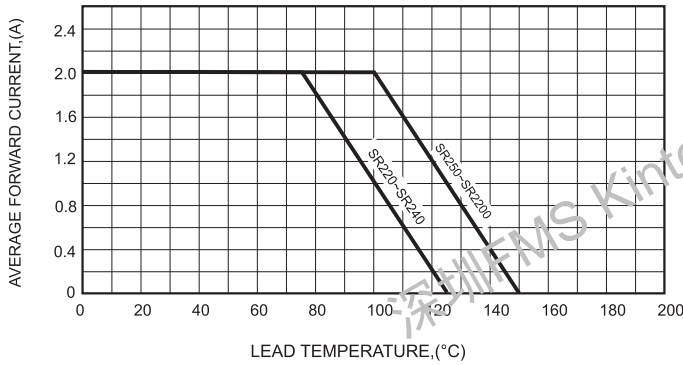

FIG.2-TYPICAL FORWARD CHARACTERISTICS

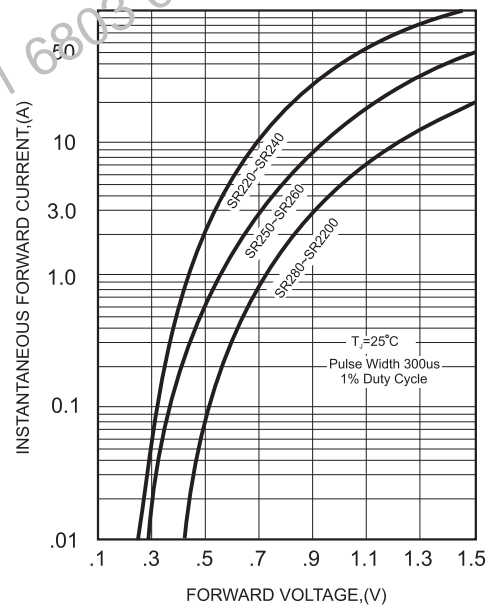

FIG.3-MAXIMUM NON-REPETITIVE FORWARD SURGE CURRENT

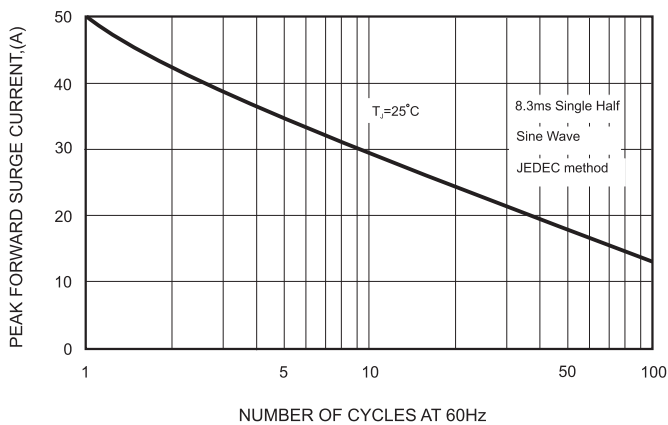

FIG.4-TYPICAL JUNCTION CAPACITANCE

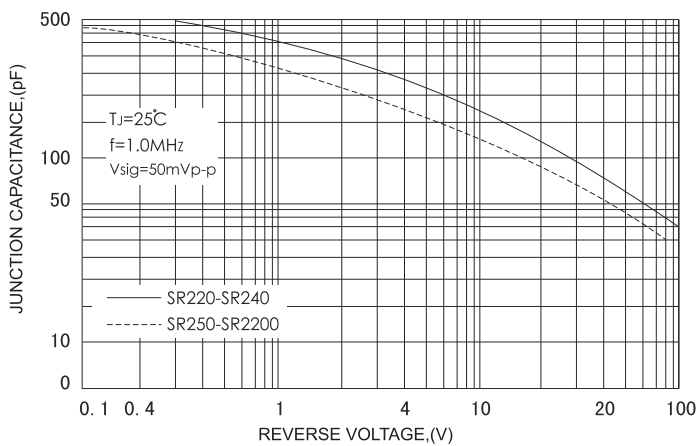
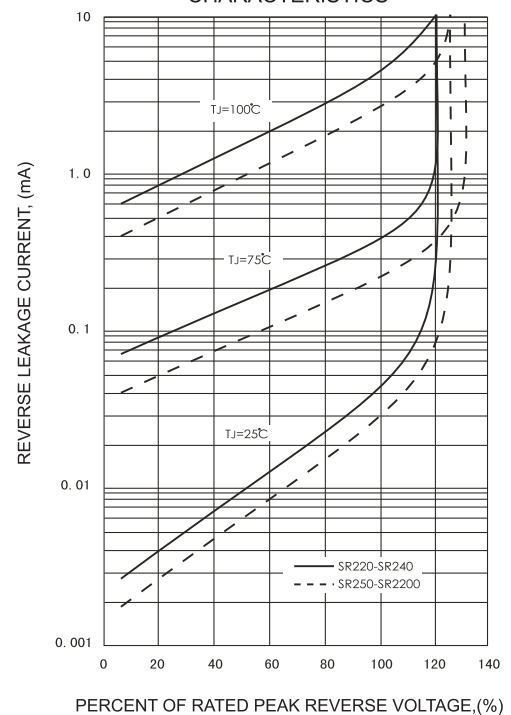



FIG.5 - TYPICAL REVERSE CHARACTERISTICS



SR220 THRU SR2200

Pinning information

Pin	Simplified outline	Symbol
Pin1 cathode Pin2 anode		

Marking

Type number	Marking code
SR220	SR220
SR230	SR230
SR240	SR240
SR250	SR250
SR260	SR260
SR280	SR280
SR2100	SR2100
SR2150	SR2150
SR2200	SR2200

Taping & bulk specifications for AXIAL devices

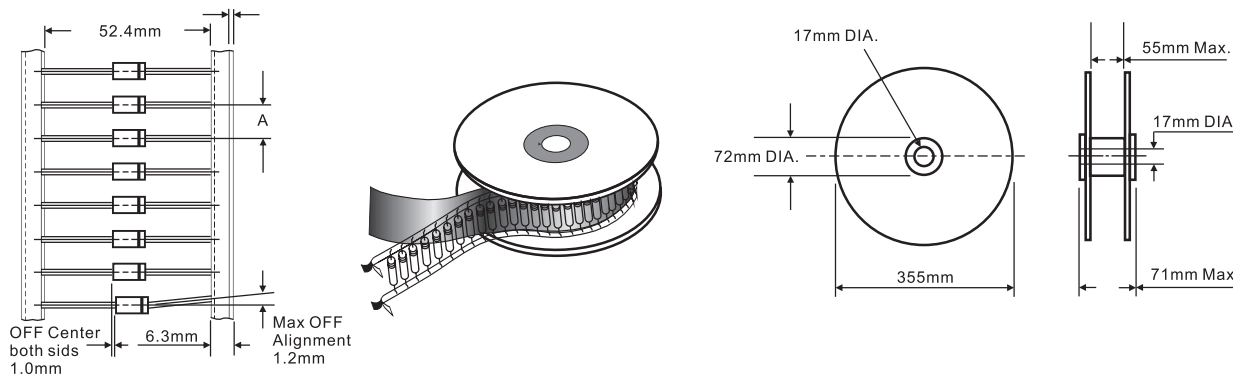

REEL PACKING

DEVICE CASE TYPE	Q'TY 1 (PCS / REEL)	COMPONENT SPACING "A" in FIG. A	CARTON SIZE (m/m)	Q'TY 2 (PCS / CARTON)	APPROX. CROSS WEIGHT(kg)
DO-41	5,000	5 mm	360 * 340 * 370	20,000	10.8

AMMO PACKING

DEVICE CASE TYPE	Q'TY 1 (PCS / BOX)	INNER BOX SIZE (m/m)	CARTON SIZE (m/m)	Q'TY 2 (PCS / CARTON)	APPROX. CROSS WEIGHT(kg)
DO-41	5,000	260 * 83 * 160	440 * 270 * 340	50,000	20.0

SR220 THRU SR2200

BULK PACKING

DEVICE CASE TYPE	Q'TY 1 (PCS / BOX)	INNER BOX SIZE (m/m)	CARTON SIZE (m/m)	Q'TY 2 (PCS / CARTON)	APPROX. CROSS WEIGHT(kg)
DO-41	1,000	194 * 84 * 20	465 * 220 * 260	50,000	20.6

Suggested thermal profiles for soldering processes

1. Lead free temperature profile wave-soldering

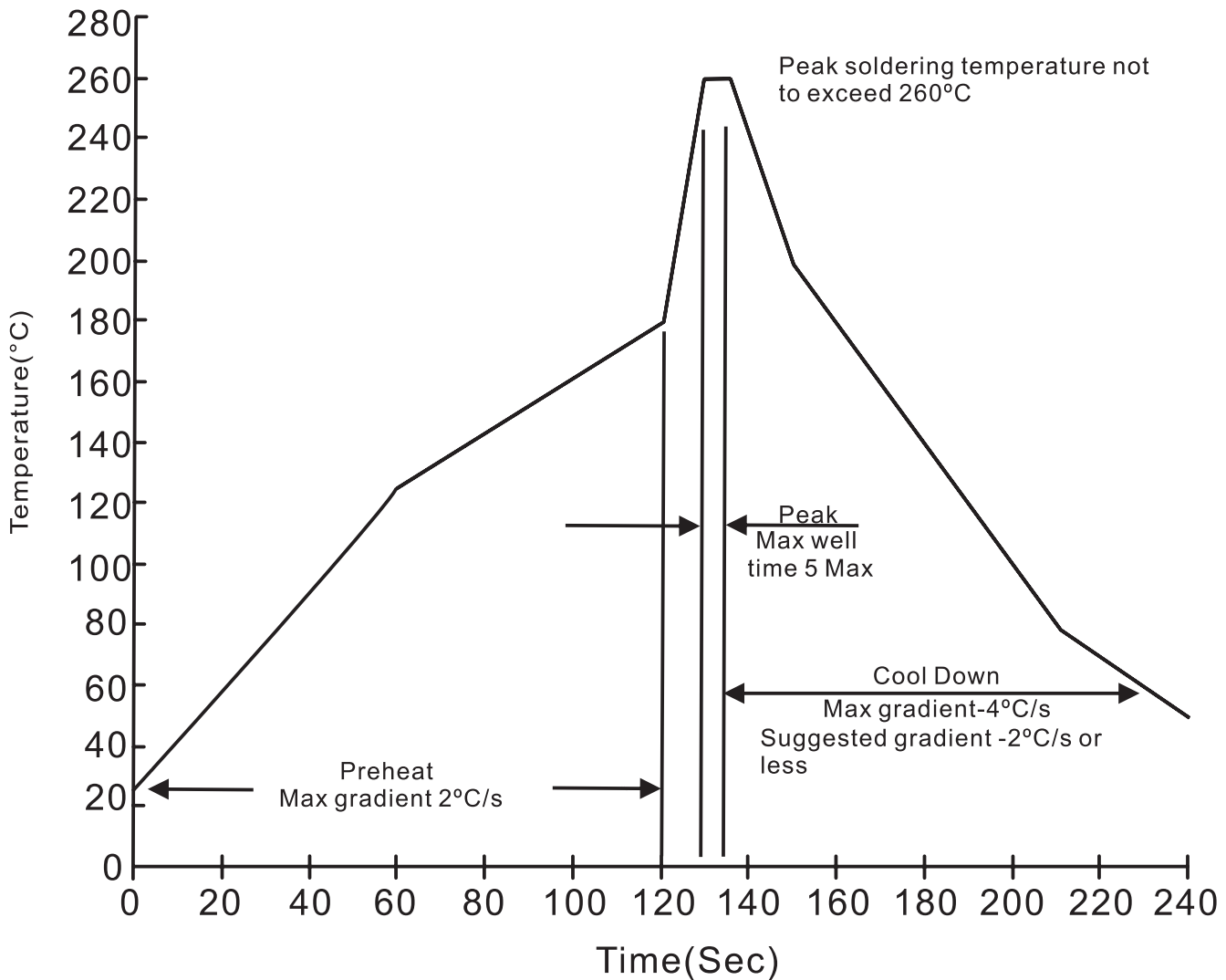

SR220 THRU SR2200**High reliability test capabilities**

Item Test	Conditions	Reference
1. Solder Resistance	at 260±5°C for 10±2sec. immerse body into solder 1/16"±1/32"	MIL-STD-750D METHOD-2031
2. Solderability	at 245±5°C for 5 sec.	MIL-STD-202F METHOD-208
3. Pull Test	1.0kg in axial lead direction for 10 sec. $I_F=2A$	MIL-STD-750D METHOD-2036
4. Bend Lead	1.0kg weight applied to each lead bending arc 90°±5° for 3 times.	MIL-STD-750D METHOD-2036
5. High Temperature Reverse Bias	$V_R=80\%$ rate at $T_J=125^\circ C$ for 168 hrs.	MIL-STD-750D METHOD-1038
6. Forward Operation Life	Rated average rectifier current at $T_A=25^\circ C$ for 500hrs.	MIL-STD-750D METHOD-1027
7. Intermittent Operation Life	$T_A = 25^\circ C$, $I_F = I_O$ On state: power on for 5 min. off state: power off for 5 min, on and off for 500 cycles.	MIL-STD-750D METHOD-1036
8. Pressure Cooker	$15P_{SIG}$ at $T_A=121^\circ C$ for 4 hrs.	JESD22-A102
9. Temperature Cycling	-55°C to +125°C dwelled for 30 min. and transferred for 5min. total 10 cycles.	MIL-STD-750D METHOD-1051
10. Thermal Shock	0°C for 5 min. rise to 100°C for 5 min. total 10 cycles.	MIL-STD-750D METHOD-1056
11. Forward Surge	8.3ms single half sine-wave superimposed on rated load, one surge.	MIL-STD-750D METHOD-4066-2
12. Humidity	at $T_A=85^\circ C$, RH=85% for 1000hrs.	MIL-STD-750D METHOD-1021
13. High Temperature Storage Life	at 175°C for 1000 hrs.	MIL-STD-750D METHOD-1031