

SCHOTTKY BARRIER RECTIFIER

VOLTAGE RANGE 80 to 200 Volts CURRENT 60 Amperes

FEATURES

- * Low switching noise
- * Low forward voltage drop
- * Low thermal resistance
- * High current capability
- * High switching capability
- * High surge capability
- * High reliability

MECHANICAL DATA

- * Case: To-220 molded plastic
- * Epoxy: Device has UL flammability classification 94V-0
- * Lead: MIL-STD-202E method 208C guaranteed
- * Mounting position: Any

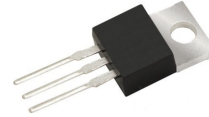

TO-220

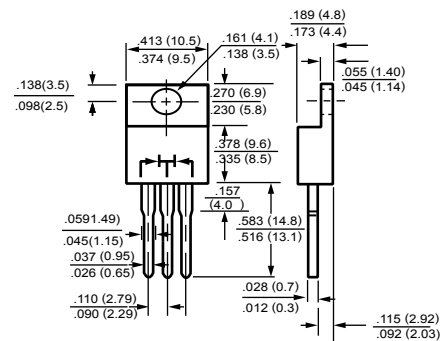

MAXIMUM RATINGS AND ELECTRICAL CHARACTERISTICS

Ratings at 25 °C ambient temperature unless otherwise specified.

Single phase, half wave, 60 Hz, resistive or inductive load.

For capacitive load, derate current by 20%.

MAXIMUM RATINGS (@ TA=25 °C unless otherwise noted)

RATINGS	SYMBOL	SR6080C	SR60100C	SR60150C	SR60200C	UNITS
Maximum Recurrent Peak Reverse Voltage	V_{RRM}	80	100	150	200	Volts
Maximum RMS Voltage	V_{RMS}	56	70	105	140	Volts
Maximum DC Blocking Voltage	V_{DC}	80	100	150	200	Volts
Maximum Average Forward Rectified Current at Derating Ambient Temperature	I_O	60				Amps
Peak Forward Surge Current 8.3 ms single half sine-wave superimposed on rated load (JEDEC method)	I_{FSM}	400				Amps
Typical Thermal Resistance (Note 1)	$R_{\theta JC}$	1.2				°C/W
	$R_{\theta JA}$	24				
Operating Temperature Range	T_J	150				°C
Storage Temperature Range	T_{STG}	-55 to + 150				°C

ELECTRICAL CHARACTERISTICS (@TA=25 °C unless otherwise noted)

CHARACTERISTICS	SYMBOL	SR6080C	SR60100C	SR60150C	SR60200C	UNITS
Maximum Instantaneous Forward Voltage at 30.0A DC	V_F	.85				Volts
Maximum Average Reverse Current at Rated DC Blocking Voltage	I_R	1.0				mA
		10				

- NOTES : 1. Thermal Resistance : Heat-sink mounted.
2. Suffix "A" = Common Anode.
3. "RoHS compliant"

RATING AND CHARACTERISTICS CURVES (SR6080C THRU SR60200C)

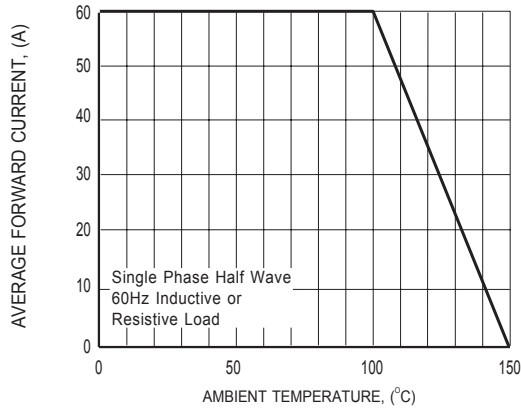

FIG.1 TYPICAL FORWARD CURRENT DERATING CURVE

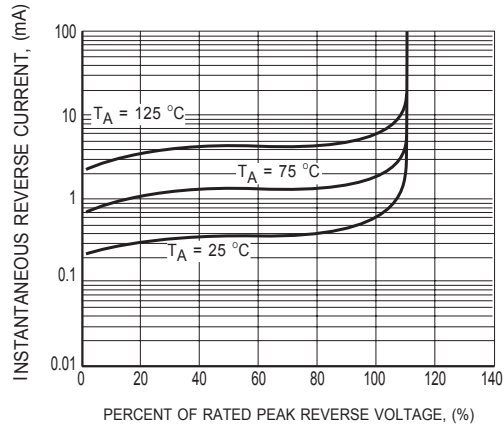

FIG.2 TYPICAL REVERSE CHARACTERISTICS

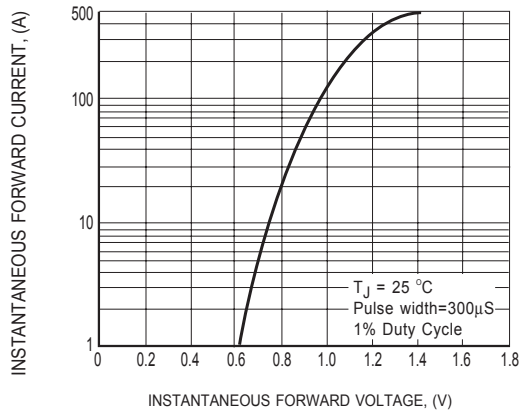

FIG.3 TYPICAL INSTANTANEOUS FORWARD CHARACTERISTICS

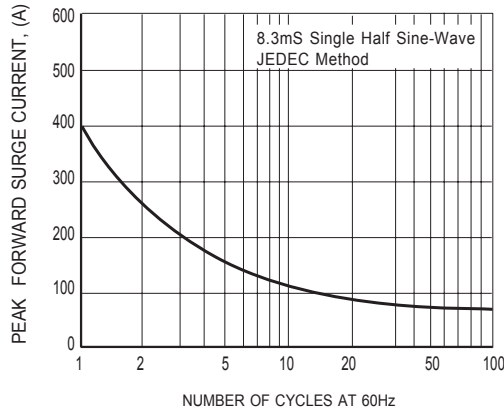

FIG.4 MAXIMUM NON-REPETITIVE FORWARD SURGE CURRENT



Attachment information about SR60XXC

1. Internal Circuit



2. Marking on the body

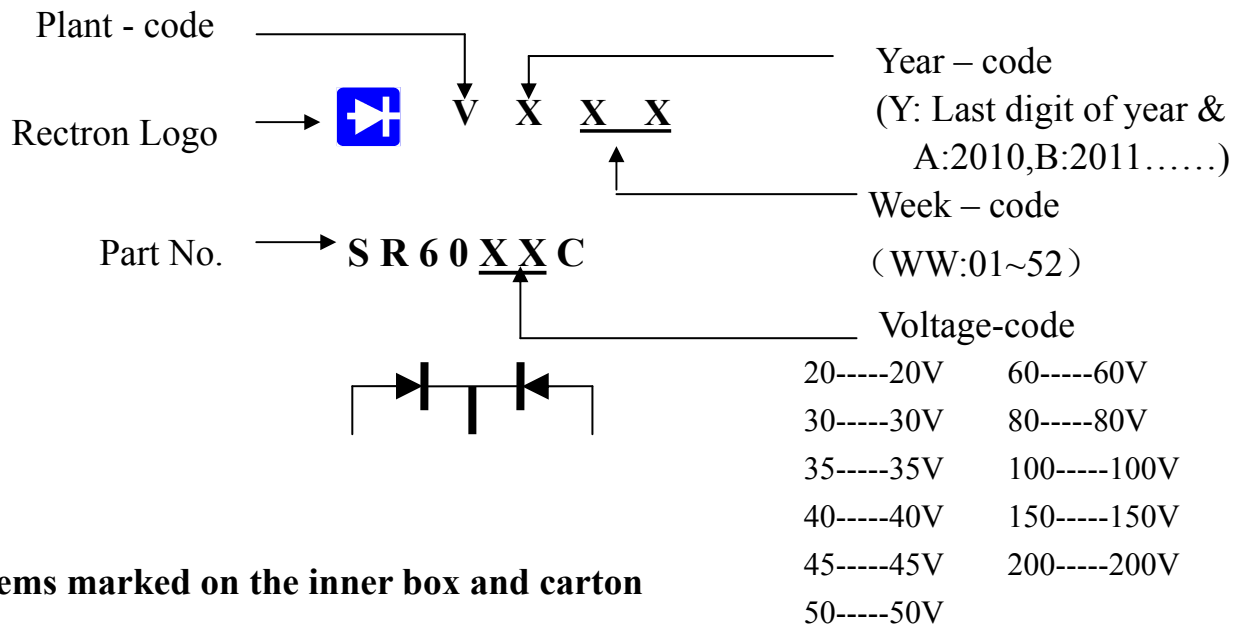

3. Items marked on the inner box and carton

3.1 On the box (for -C)

CUSTOMER
TYPE
LOT NO.
QUANTITY
Q.A.
DATE

3.2 On the carton

CUSTOMER
TYPE
QUANTITY
LOT NO.
REMARK

PACKAGING OF DIODE AND BRIDGE RECTIFIERS

TUBE PACK

PACKAGE	PACKING CODE	EA PER BOX	INNER BOX SIZE (mm)	CARTON SIZE (mm)	EA PER CARTON	WEIGHT(Kg)
TO-220	-C	1,000	555*150*40	580*230*175	5,000	15.0

DISCLAIMER NOTICE

Rectron Inc reserves the right to make changes without notice to any product specification herein, to make corrections, modifications, enhancements or other changes. Rectron Inc or anyone on its behalf assumes no responsibility or liability for any errors or inaccuracies. Data sheet specifications and its information contained are intended to provide a product description only. "Typical" parameters which may be included on RECTRON data sheets and/ or specifications can and do vary in different applications and actual performance may vary over time. Rectron Inc does not assume any liability arising out of the application or use of any product or circuit.

Rectron products are not designed, intended or authorized for use in medical, life-saving implant or other applications intended for life-sustaining or other related applications where a failure or malfunction of component or circuitry may directly or indirectly cause injury or threaten a life without expressed written approval of Rectron Inc. Customers using or selling Rectron components for use in such applications do so at their own risk and shall agree to fully indemnify Rectron Inc and its subsidiaries harmless against all claims, damages and expenditures.