

SRA820 - SRA8150

8.0 AMPS. Schottky Barrier Rectifiers

TO-220AC



Features

- ✧ UL Recognized File # E-326243
- ✧ Low power loss, high efficiency.
- ✧ High current capability, Low VF.
- ✧ High reliability
- ✧ High surge current capability.
- ✧ Epitaxial construction.
- ✧ Guard-ring for transient protection.
- ✧ For use in low voltage, high frequency inverter, free wheeling, and polarity protector application
- ✧ Green compound with suffix "G" on packing code & prefix "G" on datecode.

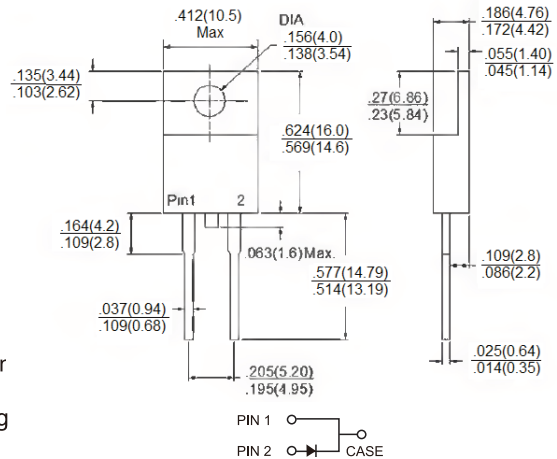

Mechanical Data

- ✧ Cases: TO-220AC molded plastic
- ✧ Epoxy: UL 94V-0 rate flame retardant
- ✧ Terminals: Pure tin plated, lead free. solderable per MIL-STD-202, Method 208 guaranteed
- ✧ Polarity: As marked
- ✧ High temperature soldering guaranteed: 260°C/10 seconds/.25", (6.35mm) from case
- ✧ Weight: 1.85 grams

Dimensions in inches and (millimeters)

Marking Diagram

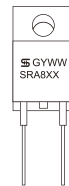

SRA8XX = Specific Device Code
 G = Green Compound
 Y = Year
 WW = Work Week

Maximum Ratings and Electrical Characteristics

Rating at 25 °C ambient temperature unless otherwise specified.

Single phase, half wave, 60 Hz, resistive or inductive load.

For capacitive load, derate current by 20%

Type Number	Symbol	SRA 820	SRA 830	SRA 840	SRA 850	SRA 860	SRA 890	SRA 8100	SRA 8150	Units
Maximum Recurrent Peak Reverse Voltage	V_{RRM}	20	30	40	50	60	90	100	150	V
Maximum RMS Voltage	V_{RMS}	14	21	28	35	42	63	70	105	V
Maximum DC Blocking Voltage	V_{DC}	20	30	40	50	60	90	100	150	V
Maximum Average Forward Rectified Current See Fig. 1	$I_{F(AV)}$	8.0								A
Peak Forward Surge Current, 8.3 ms Single Half Sine-wave Superimposed on Rated Load (JEDEC method)	I_{FSM}	150								A
Maximum Instantaneous Forward Voltage @8.0A	V_F	0.55		0.70		0.92		1.05		V
Maximum D.C. Reverse Current at Rated DC Blocking Voltage (Note1)	I_R	0.5				0.1				mA
@ $T_A=25^\circ\text{C}$		15		10		-				
@ $T_A=100^\circ\text{C}$		-				5				
Typical Junction Capacitance (Note 2)	C_j	400			300			250		pF
Typical Thermal Resistance(Note 3)	$R_{\theta JC}$	4.0								$^\circ\text{C}/\text{W}$
Operating Junction Temperature Range	T_J	-65 to +125				-65 to +150				$^\circ\text{C}$
Storage Temperature Range	T_{STG}	-65 to +150								$^\circ\text{C}$

Notes: 1. Pulse Test: 300us Pulse Width, 1% Duty Cycle
 2. Measured at 1MHz and Applied Reverse Voltage of 4.0V D.C.
 3. Mount on Heat sink of (2"x3"x0.25") Al-plate.

RATINGS AND CHARACTERISTIC CURVES (SRA820 THRU SRA8150)

FIG.1- MAXIMUM FORWARD CURRENT DERATING CURVE

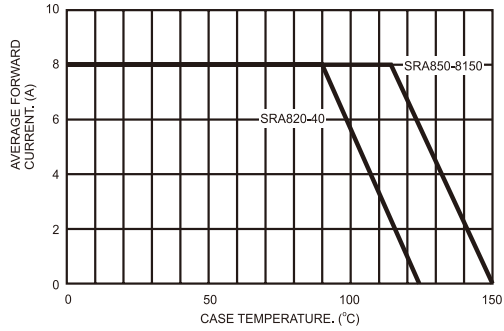

FIG.2- MAXIMUM NON-REPETITIVE FORWARD SURGE CURRENT

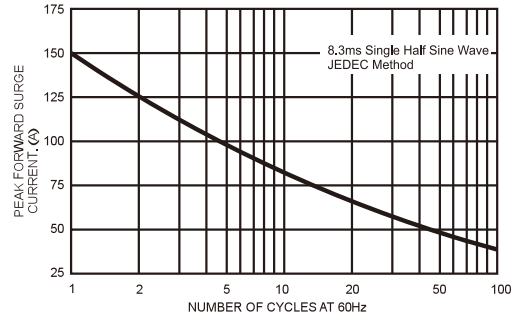

FIG.3- TYPICAL FORWARD CHARACTERISTICS

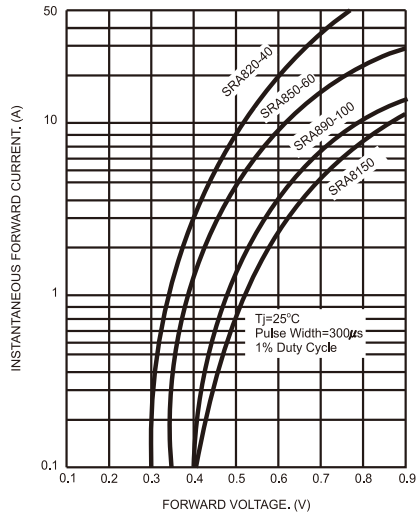

FIG.4- TYPICAL REVERSE CHARACTERISTICS

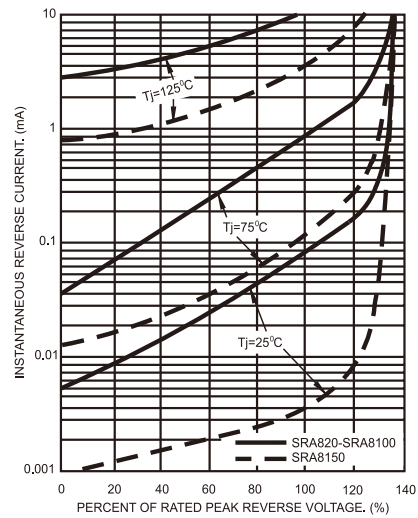

FIG.5- TYPICAL JUNCTION CAPACITANCE

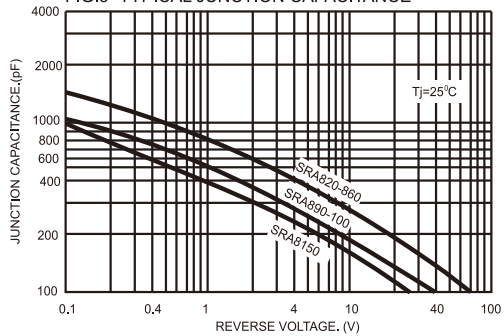

FIG.6- TYPICAL TRANSIENT THERMAL CHARACTERISTICS

