



SS32F THRU SS3200F

SURFACE MOUNT SCHOTTKY BARRIER RECTIFIER

Reverse Voltage - 20 to 200 Volts Forward Current - 3.0 Ampere

SMAF

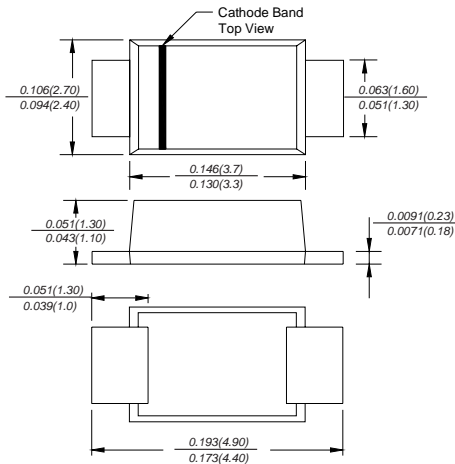

Dimensions in inches and (millimeters)

FEATURES

- ◆ The plastic package carries Underwriters Laboratory Flammability Classification 94V-0
- ◆ For surface mounted applications
- ◆ Metal silicon junction, majority carrier conduction
- ◆ Low power loss, high efficiency
- ◆ Built-in strain relief, ideal for automated placement
- ◆ High forward surge current capability
- ◆ High temperature soldering guaranteed: 260°C/10 seconds at terminals

MECHANICAL DATA

Case: JEDEC SMAF molded plastic body
Terminals: leads solderable per MIL-STD-750, Method 2026
Polarity: Color band denotes cathode end
Mounting Position: Any
Weight: 0.0018 ounce, 0.064 grams

MAXIMUM RATINGS AND ELECTRICAL CHARACTERISTICS

Ratings at 25°C ambient temperature unless otherwise specified.
 Single phase half-wave 60Hz, resistive or inductive load, for capacitive load current derate by 20%.

MDD Catalog Number	SYMBOLS	SS32F	SS33F	SS34F	SS35F	SS36F	SS38F	SS310F	SS3150F	SS3200F	UNITS	
Maximum repetitive peak reverse voltage	V_{RRM}	20	30	40	50	60	80	100	150	200	VOLTS	
Maximum RMS voltage	V_{RMS}	14	21	28	35	42	56	70	105	140	VOLTS	
Maximum DC blocking voltage	V_{DC}	20	30	40	50	60	80	100	150	200	VOLTS	
Maximum average forward rectified current at T_L (see fig.1)	$I_{(AV)}$	3.0									Amp	
Peak forward surge current 8.3ms single half sine-wave superimposed on rated load (JEDEC Method)	I_{FSM}	80.0									Amps	
Maximum instantaneous forward voltage at 3.0A	V_F	0.55			0.70			0.85		0.95	Volts	
Maximum DC reverse current $T_A=25^\circ\text{C}$ at rated DC blocking voltage $T_A=100^\circ\text{C}$	I_R	0.5						0.2			mA	
		20.0				10		2.0				
Typical junction capacitance (NOTE 1)	C_J	500			300						pF	
Typical thermal resistance (NOTE 2)	$R_{\theta JA}$	55.0									$^\circ\text{C/W}$	
Operating junction temperature range	T_J	-50 to +125					-50 to +150					$^\circ\text{C}$
Storage temperature range	T_{STG}	-50 to +150										$^\circ\text{C}$

Note: 1. Measured at 1MHz and applied reverse voltage of 4.0V D.C.
 2. P.C.B. mounted with 0.2x0.2" (5.0x5.0mm) copper pad areas



www.microdiode.com

RATINGS AND CHARACTERISTIC CURVES SS32F THRU SS3200F

AVERAGE FORWARD RECTIFIED CURRENT, AMPERES

FIG. 1- FORWARD CURRENT DERATING CURVE

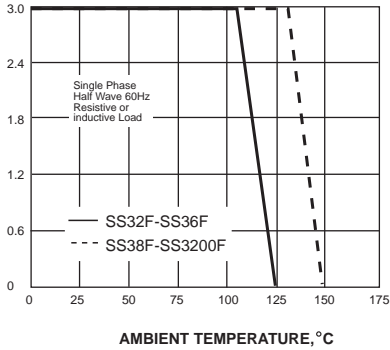

PEAK FORWARD SURGE CURRENT, AMPERES

FIG. 2-MAXIMUM NON-REPETITIVE PEAK FORWARD SURGE CURRENT

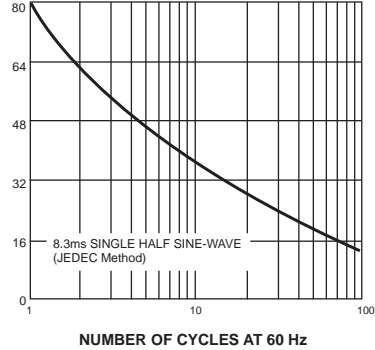

INSTANTANEOUS FORWARD CURRENT, AMPERES

FIG. 3-TYPICAL INSTANTANEOUS FORWARD CHARACTERISTICS

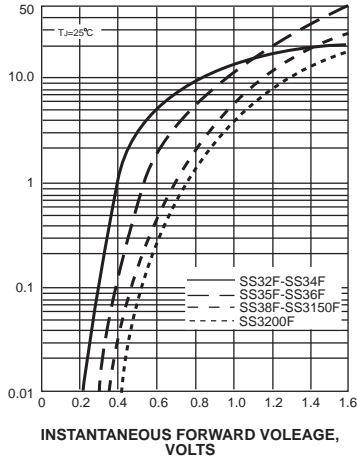

INSTANTANEOUS REVERSE CURRENT, MILLIAMPERES

FIG. 4-TYPICAL REVERSE CHARACTERISTICS

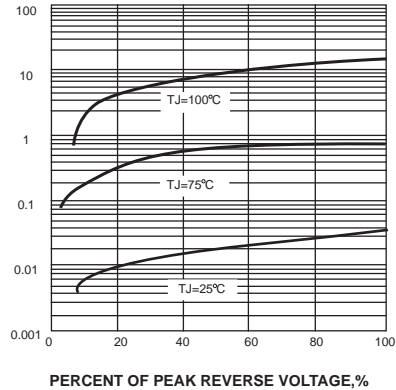

JUNCTION CAPACITANCE, pF

FIG. 5-TYPICAL JUNCTION CAPACITANCE

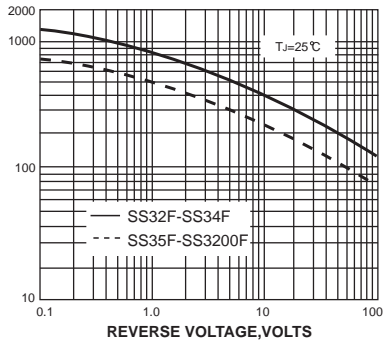

TRANSIENT THERMAL IMPEDANCE, °C/W

FIG. 6-TYPICAL TRANSIENT THERMAL IMPEDANCE

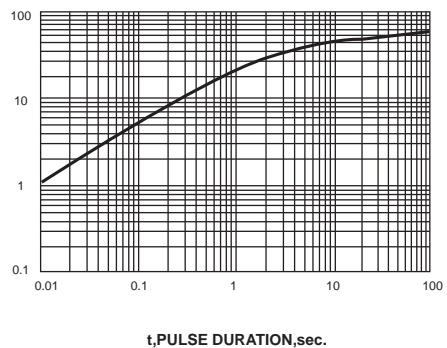

The cruve graph is for reference only, can't be the basis for judgment(曲线图仅供参考)!



www.microdiode.com