

Features and Benefits

- 4.5V to 24V Operation
- -40°C to 150°C Superior temperature operation
- Bipolar technology
- Open-collector 25 mA output
- Reverse battery protection
- Small Size SOT23 3L or SIP 3L
- Solid-state reliability
- Resistant to physical stress
- Activate with small, commercially available permanent magnets

Application Examples

- Brushless DC motor commutation
- Automotive, Consumer and Industrial
- Solid-state switch
- Speed measurement
- Revolution counting
- Angular position detection
- Proximity detection

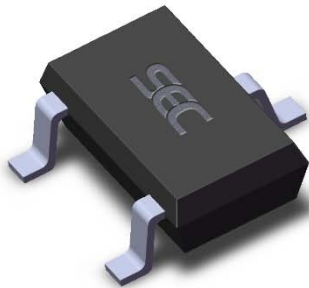

3 pin SOT23 (suffix SO)



3 pin SIP (suffix UA)

Functional Block Diagram

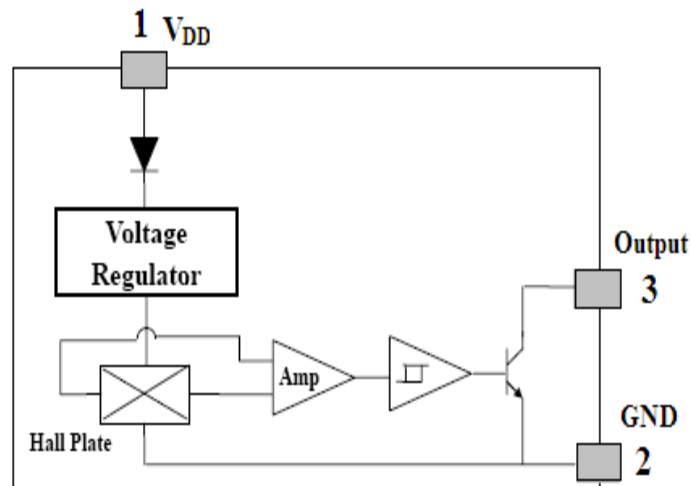

SIP Package
 Pin 1 – V_{DD}
 Pin 2 – GND
 Pin 3 – OUT

SOT Package
 Pin 1 – V_{DD}
 Pin 2 – OUT
 Pin 3 – GND

General Description

The SS41F is an integrated Hall effect latched sensor designed for electronic commutation of brush-less DC motor applications. The device integrates a voltage regulator, reverse battery protection diode, Hall sensor with dynamic offset cancellation system, temperature compensation circuitry, small signal amplifier, Schmitt trigger and an open-collector output to sink up to 25 mA.

These Hall-effect switches are monolithic integrated circuits with tighter magnetic specifications, designed to operate continuously over extended temperatures to +150°C, and are more stable with both

temperature and supply voltage changes. If a magnetic flux density larger than threshold B_{op} , Output is turned on (low). The output state is held until a magnetic flux density reversal falls below B_{rp} , causing Output to be turned off (high).

Thanks to its wide operating voltage range and extended choice of temperature range, it is quite suitable for use in DC motor applications.

The device is delivered in a Small Outline Transistor (SOT) or in a Plastic Single In Line (SIP 3L flat). Both 3-lead packages are RoHS compliant.

Glossary of Terms

MilliTesla (mT), Gauss	Units of magnetic flux density: 1mT = 10 Gauss
RoHS	Restriction of Hazardous Substances
Operating Point (B_{OP})	Magnetic flux density applied on the branded side of the package which turns the output driver ON ($V_{OUT} = V_{DSon}$)
Release Point (B_{RP})	Magnetic flux density applied on the branded side of the package which turns the output driver OFF ($V_{OUT} = high$)

Pin Definitions and Descriptions

SOT Pin №	SIP Pin №	Name	Type	Function
1	1	V _{DD}	Supply	Supply Voltage pin
2	3	OUT	Output	Open Drain Output pin
3	2	GND	Ground	Ground pin

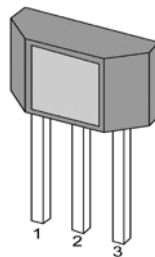
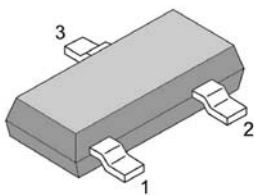

Absolute Maximum Ratings

Parameter	Symbol	Value	Units
Supply Voltage	V _{DD}	28	V
Supply Current	I _{DD}	50	mA
Output Voltage	V _{OUT}	28	V
Output Current	I _{OUT}	50	mA
Storage Temperature Range	T _S	-65 to 170	°C

Operating Temperature Range	Symbol	Value	Units
Temperature Suffix "E"	T _A	-40 to 85	°C
Temperature Suffix "K"	T _A	-40 to 125	°C
Temperature Suffix "L"	T _A	-40 to 150	°C

Exceeding the absolute maximum ratings may cause permanent damage. Exposure to absolute-maximum- rated conditions for extended periods may affect device reliability.

General Electrical Specifications

DC Operating Parameters $T_A = 25^\circ\text{C}$, $V_{DD} = 4.5\text{V to } 24\text{V}$ (unless otherwise specified)

Parameter	Symbol	Test Conditions	Min	Typ	Max	Units
Supply Voltage	V_{DD}	Operating	4.5		24	V
Supply Current	I_{DD}	$B < B_{RP}$		5	10	mA
Output Saturation Voltage	V_{DSon}	$I_{OUT} = 20\text{mA}$, $B > B_{OP}$		0.4	0.5	V
Output Leakage Current	I_{OFF}	$B < B_{RP}$ $V_{OUT} = 24\text{V}$		0.01	5	μA
Output Rise Time	t_r	$R_L = 1\text{K}\Omega$, $C_L = 20\text{pF}$		0.3	1.5	μs
Output Fall Time	t_f	$R_L = 1\text{K}\Omega$, $C_L = 20\text{pF}$		0.3	1.5	μs

Magnetic Specifications

DC Operating Parameters $V_{DD} = 4.5$ to 24V (unless otherwise specified)

Package	Parameter	Symbol	Test Conditions	Min	Typ	Max	Units
UA	Operating Point	B_{OP}	$T_a = 25^\circ\text{C}$, $V_{DD} = 12\text{V DC}$	5	45	90	G
	Release Point	B_{RP}		-90	-45	-5	G
	Hysteresis	B_{HYST}			90		G
SO	Operating Point	B_{OP}	$T_a = 25^\circ\text{C}$, $V_{DD} = 12\text{V DC}$	-90	-45	-5	G
	Release Point	B_{RP}		5	45	90	G
	Hysteresis	B_{HYST}			90		G

Output Behavior versus Magnetic Pole

DC Operating Parameters $T_A = -40^\circ\text{C to } 150^\circ\text{C}$, $V_{DD} = 4.5$ to 24V (unless otherwise specified)

Test Conditions (UA)	Test Conditions (SO)	OUT
$B < B_{RP}$	$B > B_{RP}$	High
$B > B_{OP}$	$B < B_{OP}$	Low

The SOT-23 device is reversed from the UA package. The SOT-23 output transistor will be turned on (drops low) in the presence of a sufficiently strong North pole magnetic field applied to the marked face and turned off (hoists high) in the presence of a sufficiently strong South pole magnetic field.

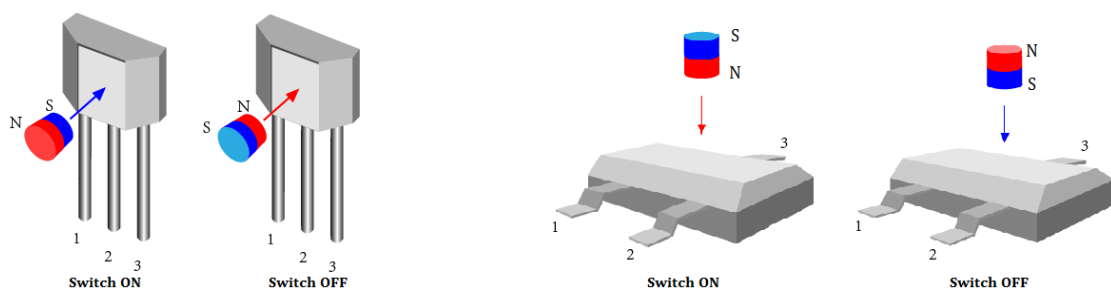

Application Information

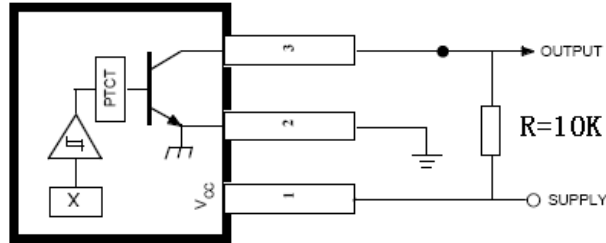

Package Information

Package TO, 3-Pin SIP:

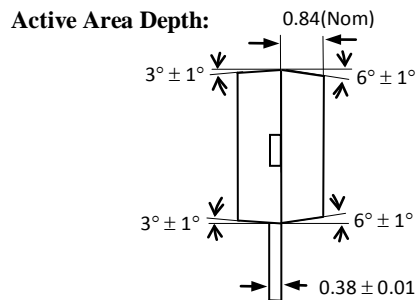
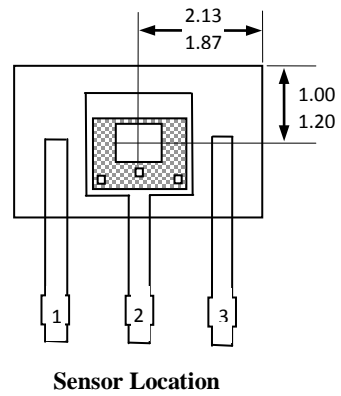
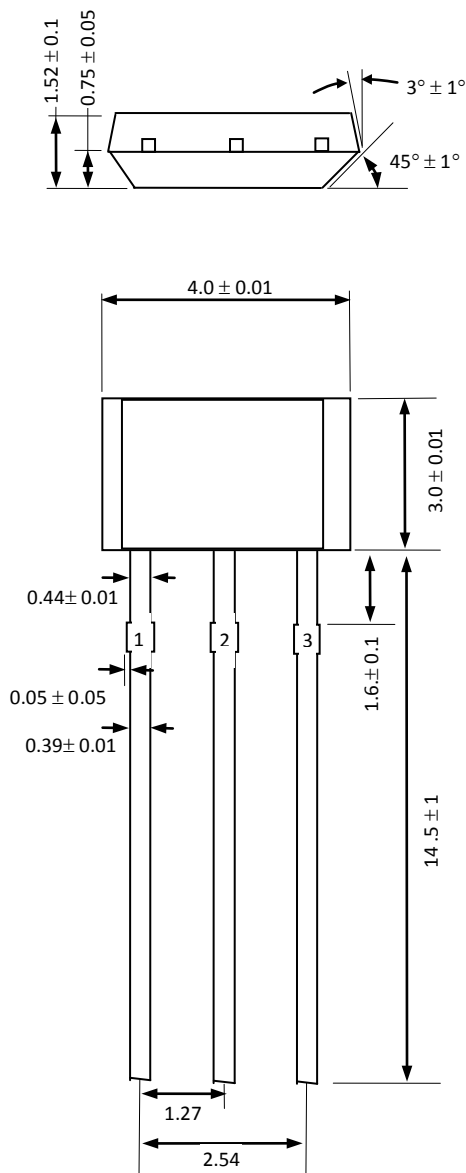

Notes:

- 1). Controlling dimension : mm ;
- 2). Leads must be free of flash and plating voids ;
- 3). Do not bend leads within 1 mm of lead to package interface ;
- 4). PINOUT: Pin 1 V_{DD}
Pin 2 GND
Pin 3 Output

Package SO, 3-Pin SOT-23:

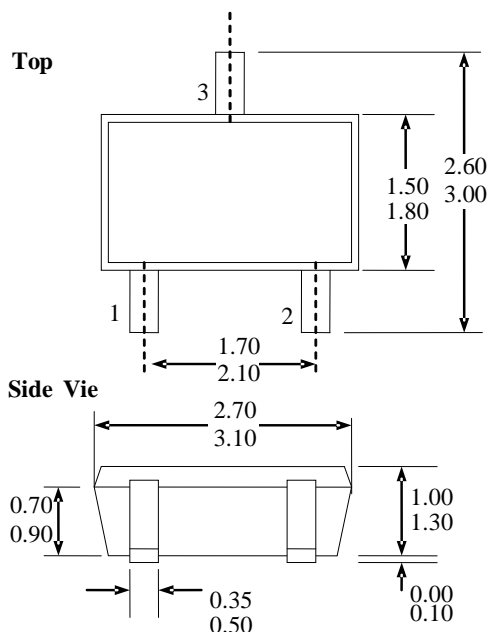

Notes

- 1). PINOUT: Pin 1 V_{DD}
Pin 2 Output
Pin 3 GND
- 2). All dimensions are in millimeters;

End View

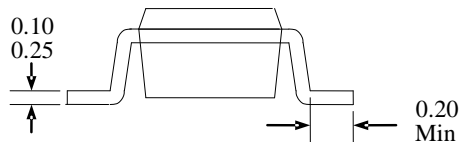

Ordering Information

Part No.	Pb-free	Temperature Code	Package Code	Packing
SS41FESOT	YES	-40°C to 85°C	SOT-23	7-in. reel, 3000 pieces/ reel
SS41FEUA	YES	-40°C to 85°C	TO-92	Bulk, 1000 pieces/ bag
SS41FKSOT	YES	-40°C to 125°C	SOT-23	7-in. reel, 3000 pieces/ reel
SS41FKUA	YES	-40°C to 125°C	TO-92	Bulk, 1000 pieces/ bag
SS41FLSOT	YES	-40°C to 150°C	SOT-23	7-in. reel, 3000 pieces/ reel
SS41FLUA	YES	-40°C to 150°C	TO-92	Bulk, 1000 pieces/ bag