

Silicon Epitaxial Planar Transistor

SS8050W

FEATURES

- Collector Current.($I_C= 1.5A$)
- Complementary To SS8550W.
- Collector dissipation: $P_C=200mW(T_C=25^{\circ}C)$

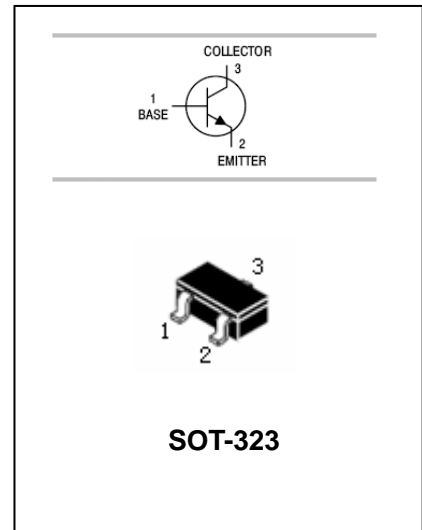

APPLICATIONS

- High Collector Current.

ORDERING INFORMATION

Type No.	Marking	Package Code
SS8050W	Y1	SOT-323

MAXIMUM RATING @ $T_a=25^{\circ}C$ unless otherwise specified

Symbol	Parameter	Ratings	Units
V_{CBO}	Collector-Base Voltage	40	V
V_{CEO}	Collector-Emitter Voltage	25	V
V_{EBO}	Emitter-Base Voltage	6	V
I_C	Collector Current -Continuous	1.5	A
P_C	Collector Dissipation	200	mW
T_j, T_{stg}	Junction and Storage Temperature	-55~150	$^{\circ}C$

Silicon Epitaxial Planar Transistor**SS8050W****ELECTRICAL CHARACTERISTICS @ Ta=25°C unless otherwise specified**

Parameter	Symbol	Test conditions	MIN	TYP	MAX	UNIT
Collector-base breakdown voltage	$V_{(BR)CBO}$	$I_C=100\mu A, I_E=0$	40			V
Collector-emitter breakdown voltage	$V_{(BR)CEO}$	$I_C=2mA, I_B=0$	25			V
Emitter-base breakdown voltage	$V_{(BR)EBO}$	$I_E=-100\mu A, I_C=0$	5			V
Collector cut-off current	I_{CBO}	$V_{CB}=40V, I_E=0$			0.1	μA
Collector cut-off current	I_{CEO}	$V_{CE}=20V, I_B=0$			0.1	μA
Emitter cut-off current	I_{EBO}	$V_{EB}=5V, I_C=0$			0.1	μA
DC current gain	h_{FE}	$V_{CE}=1V, I_C=100mA$	120		400	
		$V_{CE}=1V, I_C=800mA$	40			
Collector-emitter saturation voltage	$V_{CE(sat)}$	$I_C=800mA, I_B=80mA$			0.5	V
Base-emitter saturation voltage	$V_{BE(sat)}$	$I_C=800mA, I_B=80mA$			1.2	V
Base-emitter voltage	V_{BE}	$V_{CE}=1V, I_C=10mA$			1	V
Transition frequency	f_T	$V_{CE}=10V, I_C=50mA$ $f=30MHz$	100			MHz

CLASSIFICATION OF $h_{FE(1)}$

Rank	L	H	J
Range	120-200	200-350	300-400

Silicon Epitaxial Planar Transistor

SS8050W

TYPICAL CHARACTERISTICS @ Ta=25°C unless otherwise specified

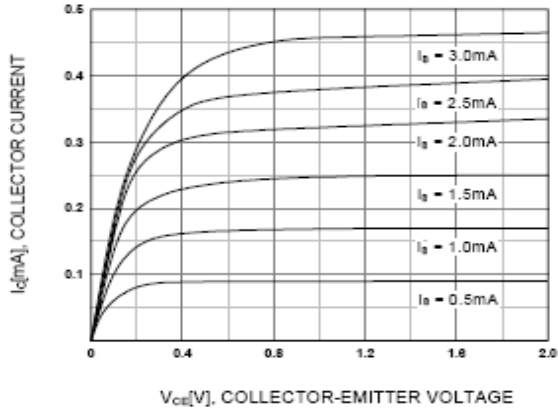

Figure 1. Static Characteristic

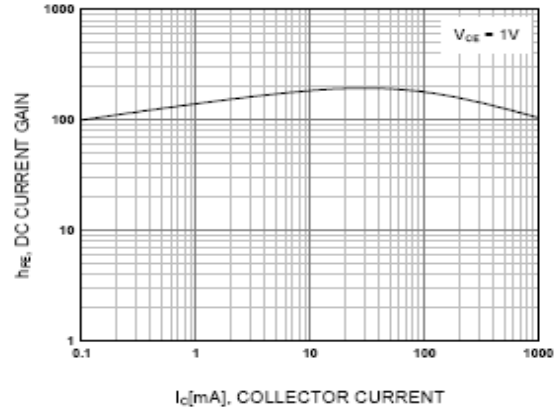

Figure 2. DC current Gain

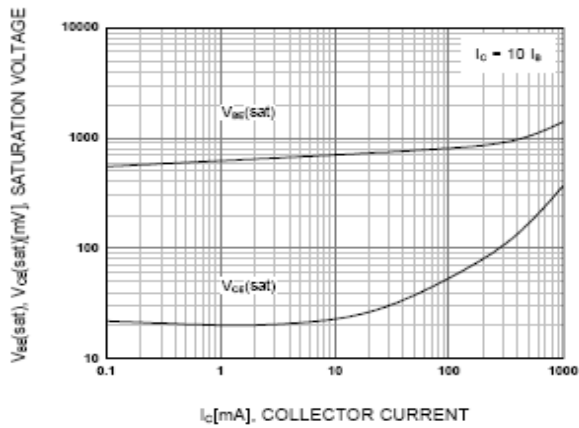

Figure 3. Base-Emitter Saturation Voltage
Collector-Emitter Saturation Voltage

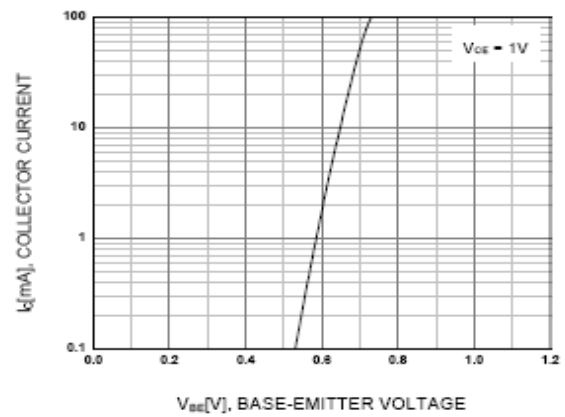

Figure 4. Base-Emitter On Voltage

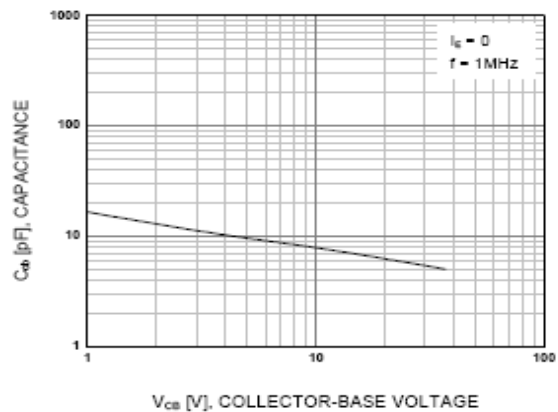

Figure 5. Collector Output Capacitance

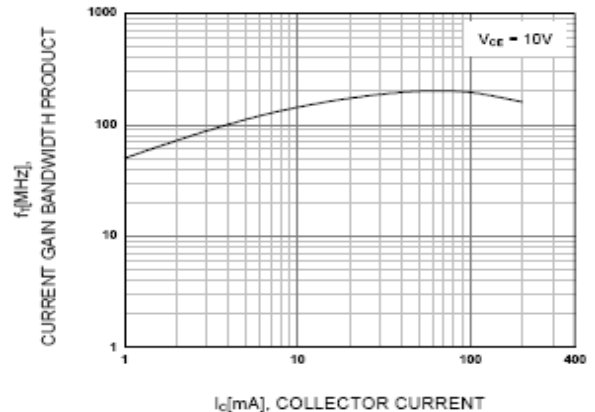

Figure 6. Current Gain Bandwidth Product

Silicon Epitaxial Planar Transistor

SS8050W

PACKAGE OUTLINE

Plastic surface mounted package

SOT-323

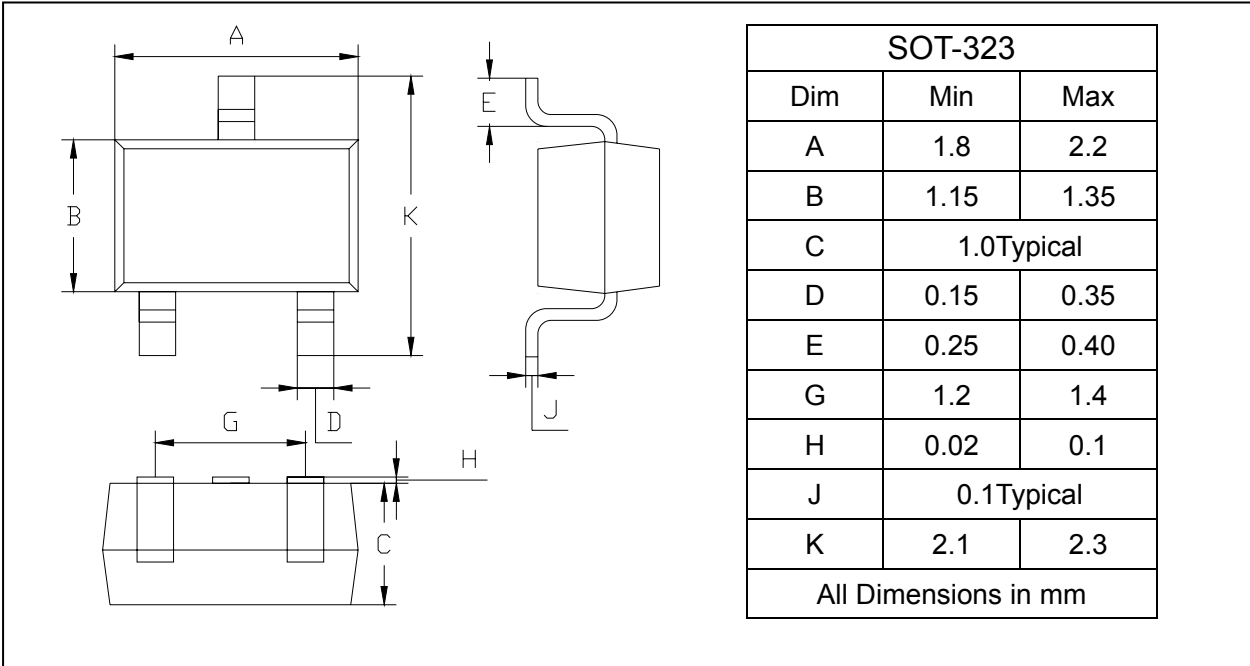

PACKAGE INFORMATION

Device	Package	Shipping
SS8050W	SOT-323	3000/Tape&Reel