

ST-1KLA

The ST-1KLA is a high-sensitivity silicon phototransistor mounted in durable, hermetically sealed TO-18 metal can which provide years of reliable performance, even under demanding conditions such as use outdoors.

FEATURES

- Durable
- High reliability in demanding environments
- Two leads

APPLICATIONS

- Smoke detector
- Infrared sensors
- Optical switches
- Optical detectors

MAXIMUM RATINGS

(Ta=25°C)

Parameter	Symbol	Rating	Unit
C-E Voltage	V _{CEO}	40	V
E-C Voltage	V _{ECO}	4	V
Collector current	I _c	50	mA
Collector power dissipation	P _c	150	mW
Operating Temperature	T _{opr}	-35~+125	°C
Storage Temperature	T _{stg}	-50~+150	°C
Soldering temperature *1	T _{sol}	260	°C

Notes : *1. For MAX.5 seconds at the position of 2mm from the package

DIMENSION (Unit : mm)

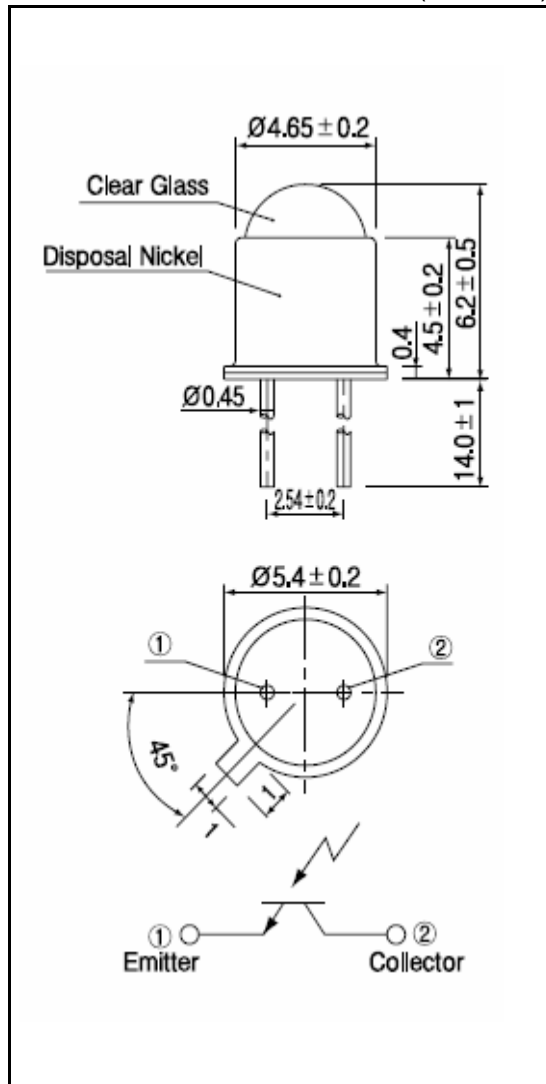

ELECTRO-OPTICAL CHARACTERISTICS

(Ta=25°C, unless otherwise noted)

Parameter	Symbol	Conditions	Min	Typ	Max	Unit
Collector dark current	I _{CEO}	V _{CEO} =10V		1	200	nA
Light current	I _L	V _{CE} =10V, 200lx	1.5	6.0	16	mA
C-E Saturation voltage	V _{CE(sat)}	I _c =5mA, 2000lx		0.2	0.4	V
Switching speeds	Rise time	V _{CC} =10V, I _c =mA, R _L =100Ω	-	8	-	ns
	Fall time		-	10	-	ns
Spectral sensitivity	λ		500~1050			nm
Peak Wavelength	λ _p		-	880	-	nm
Half angle	ΘΔ		-	±15	-	deg.

Notes : *2. Irradiance by CIE standard light source A (2850K tungsten lamp)

ST-1KLA

Collector Current Vs. C-E Voltage

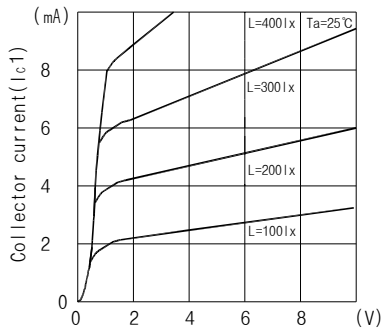

Collector Dark Current Vs. Ambient Temperature

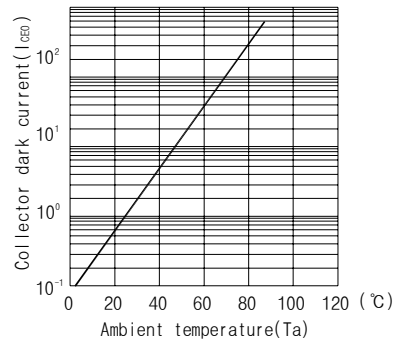

Collector power dissipation Vs. Ambient Temperature

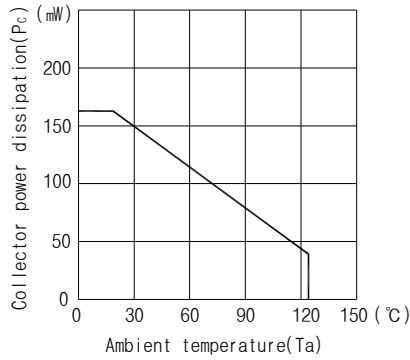

Relative Sensitivity Vs. Wavelength

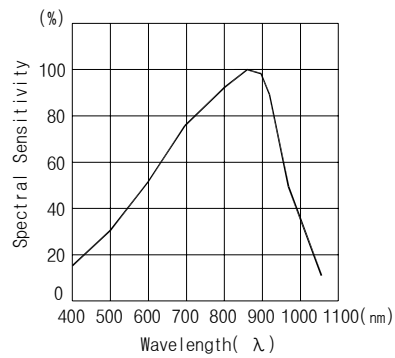

Switching time Vs. Load resistance

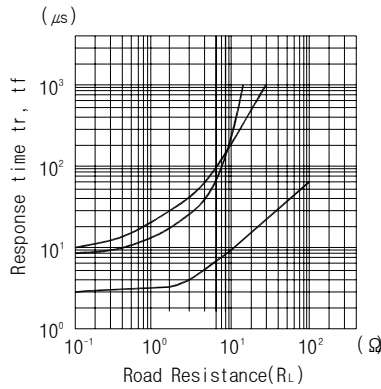

Radiant Pattern

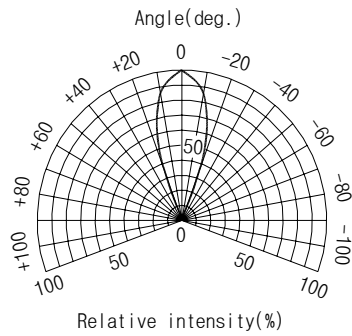

Switching time measurement circuit

