

**Previous Datasheet**

前のデータシート

**Index**

目次

**Next Data Sheet**

次のデータシート



---

***DISCRETE POWER DIODES and THYRISTORS***  
***DATA BOOK***

---

---

D-460

**To Order**

ご注文



Bulletin I25179/B

**International**  
**IOR Rectifier**

## ST183S SERIES

**INVERTER GRADE THYRISTORS**

**Stud Version**

### Features

- All diffused design
- Center amplifying gate
- Guaranteed high dv/dt
- Guaranteed high di/dt
- High surge current capability
- Low thermal impedance
- High speed performance

195A

### Typical Applications

- Inverters
- Choppers
- Induction heating
- All types of force-commutated converters

### Major Ratings and Characteristics

Parameters	ST183S	Units
$I_{T(AV)}$	195	A
	@ $T_C$	85 °C
$I_{T(RMS)}$	306	A
$I_{TSM}$	@ 50Hz	4900 A
	@ 60Hz	5130 A
$I^2t$	@ 50Hz	120 KA <sup>2</sup> s
	@ 60Hz	110 KA <sup>2</sup> s
$V_{DRM}/V_{RRM}$	400 to 800	V
$t_q$ range	10 to 20	μs
$T_J$	- 40 to 125	°C

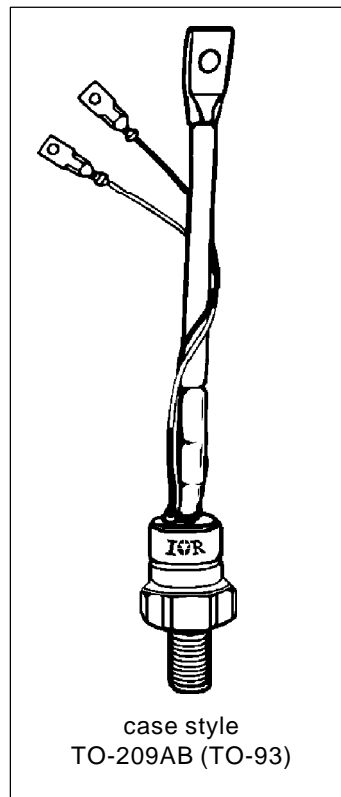



ST183S Series

**ELECTRICAL SPECIFICATIONS**

Voltage Ratings

Type number	Voltage Code	$V_{DRM}/V_{RRM}$ , maximum repetitive peak voltage V	$V_{RSM}$ , maximum non-repetitive peak voltage V	$I_{DRM}/I_{RRM}$ max. @ $T_J = T_J$ max. mA
ST183S	04	400	500	40
	08	800	900	

Current Carrying Capability

Frequency							Units
	$I_{TM}$	$I_{TM}$	$I_{TM}$	$I_{TM}$	$I_{TM}$	$I_{TM}$	
50Hz	570	370	900	610	7040	5220	A
400Hz	560	360	940	630	3200	2280	
1000Hz	500	300	925	610	1780	1200	
2500Hz	340	190	760	490	880	560	
Recovery voltage Vr	50	50	50	50	50	50	V
Voltage before turn-on Vd	$V_{DRM}$		$V_{DRM}$		$V_{DRM}$		
Rise of on-state current di/dt	50	50	-	-	-	-	A/µs
Case temperature	60	85	60	85	60	85	°C
Equivalent values for RC circuit	47Ω / 0.22µF		47Ω / 0.22µF		47Ω / 0.22µF		

On-state Conduction

Parameter	ST183S	Units	Conditions		
$I_{T(AV)}$ Max. average on-state current @ Case temperature	195	A	180° conduction, half sine wave		
	85	°C			
$I_{T(RMS)}$ Max. RMS on-state current	306	A	DC @ 74°C case temperature		
$I_{TSM}$ Max. peak, one half cycle, non-repetitive surge current	4900		t = 10ms	No voltage	Sinusoidal half wave, Initial $T_J = T_J$ max
	5130		t = 8.3ms	reapplied	
	4120		t = 10ms	100% $V_{RRM}$	
	4310	t = 8.3ms	reapplied		
$I^2t$ Maximum $I^2t$ for fusing	120	KA <sup>2</sup> s	t = 10ms	No voltage	Initial $T_J = T_J$ max
	110		t = 8.3ms	reapplied	
	85		t = 10ms	100% $V_{RRM}$	
	78		t = 8.3ms	reapplied	
$I^2\sqrt{t}$ Maximum $I^2\sqrt{t}$ for fusing	1200	KA <sup>2</sup> /s	t = 0.1 to 10ms, no voltage reapplied		



ST183S Series

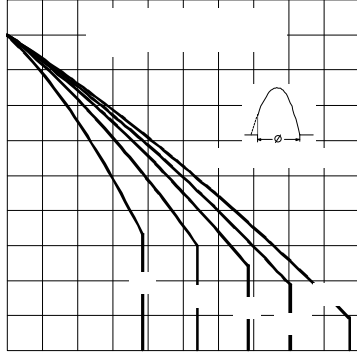

Fig. 1 - Current Ratings Characteristics

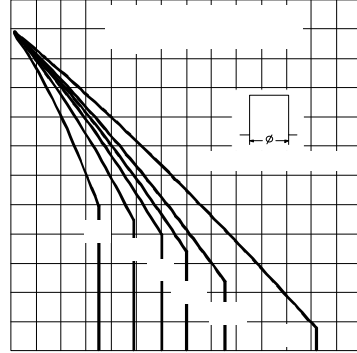

Fig. 2 - Current Ratings Characteristics

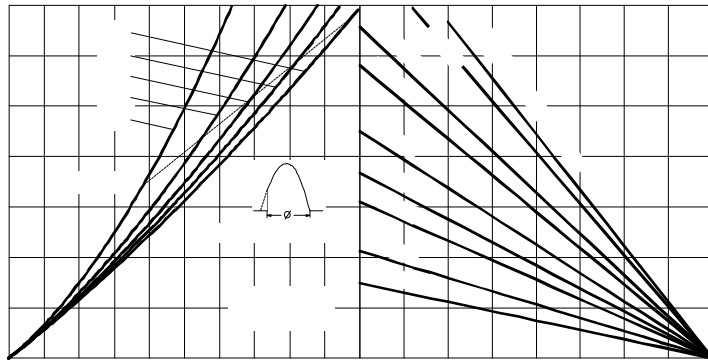

Fig. 3 - On-state Power Loss Characteristics

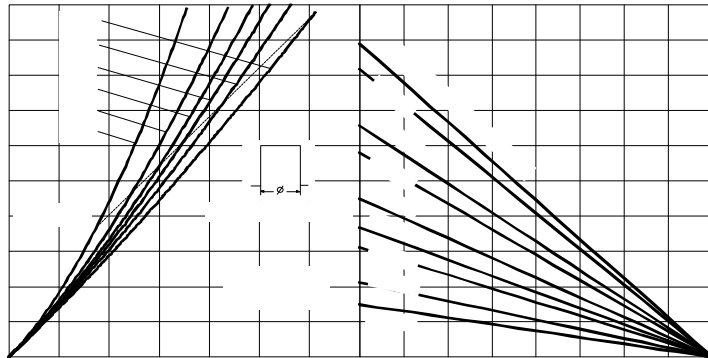

Fig. 4 - On-state Power Loss Characteristics



ST183S Series

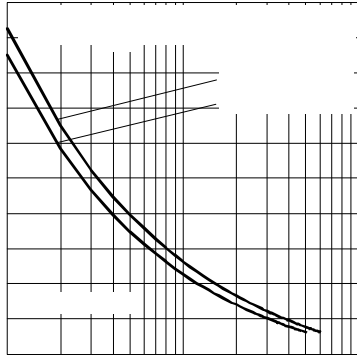

Fig. 5 - Maximum Non-repetitive Surge Current

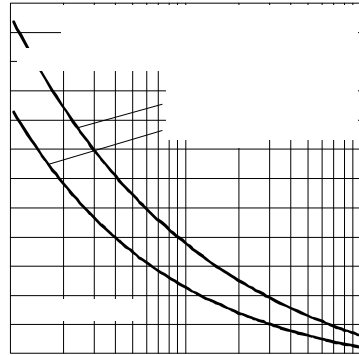

Fig. 6 - Maximum Non-repetitive Surge Current

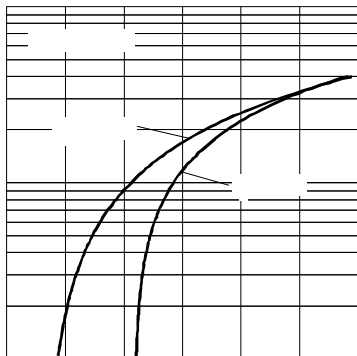

Fig. 7 - On-state Voltage Drop Characteristics

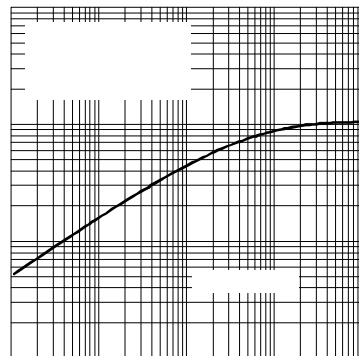

Fig. 8 - Thermal Impedance  $Z_{thJC}$  Characteristic

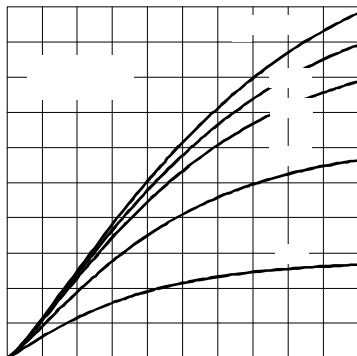

Fig. 9 - Reverse Recovered Charge Characteristics

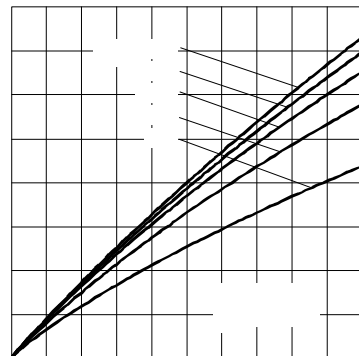

Fig. 10 - Reverse Recovery Current Characteristics



ST183S Series

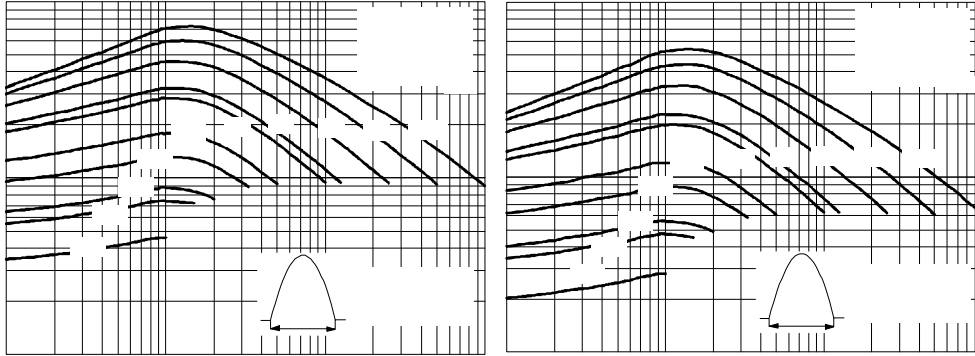

Fig. 11 - Frequency Characteristics

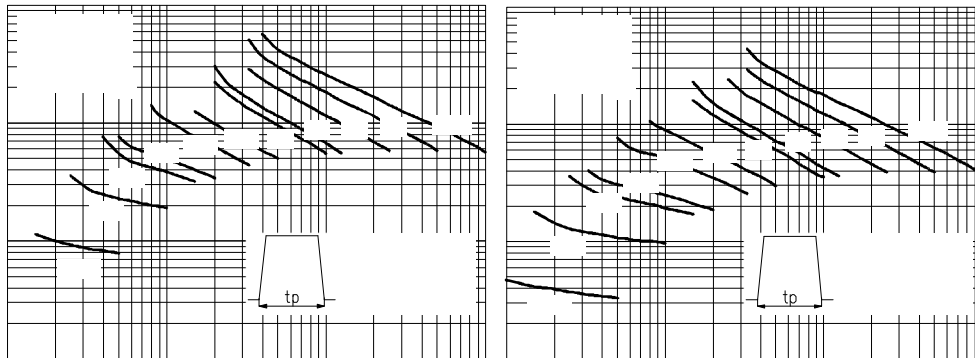

Fig. 12 - Frequency Characteristics

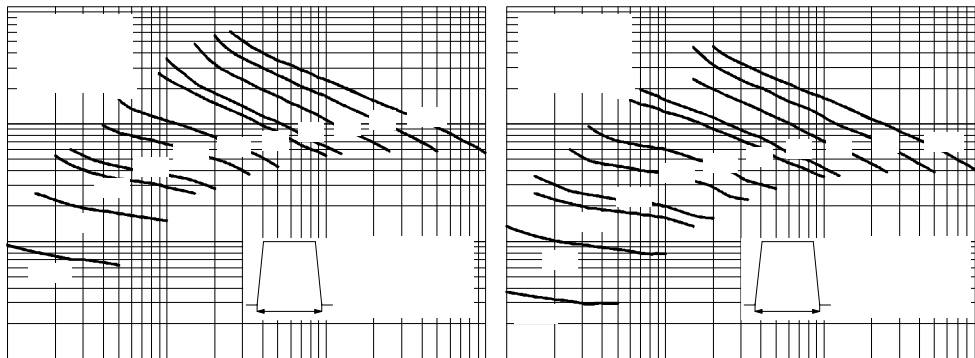

Fig. 13 - Frequency Characteristics

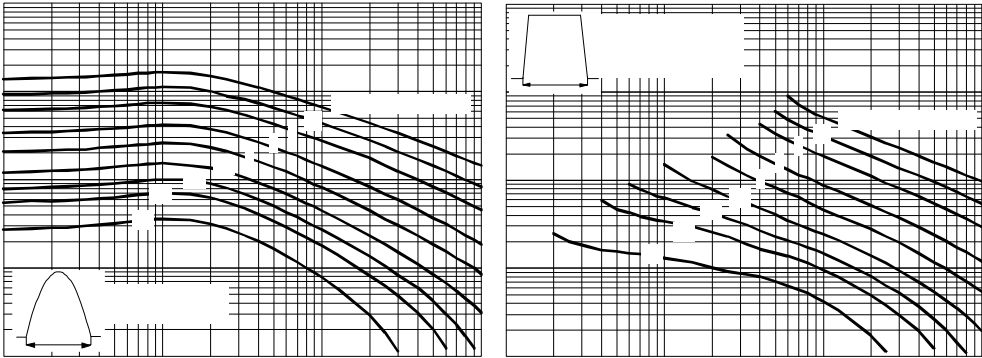

Fig. 14 - Maximum On-state Energy Power Loss Characteristics

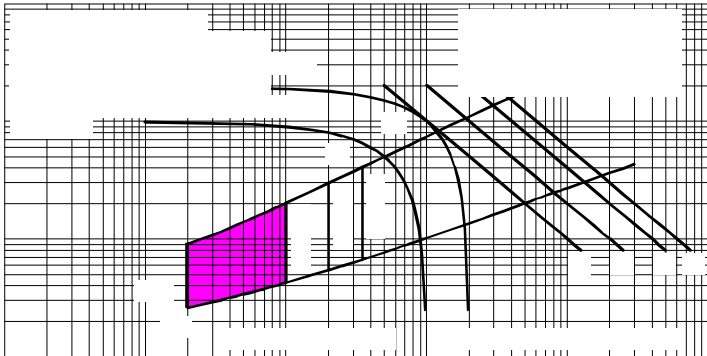

Fig. 15 - Gate Characteristics



ST183S Series

On-state Conduction

Parameter	ST183S	Units	Conditions
$V_{TM}$ Max. peak on-state voltage	1.80	V	$I_{TM} = 600A, T_J = T_J \text{ max}, t_p = 10\text{ms sine wave pulse}$
$V_{T(TO)1}$ Low level value of threshold voltage	1.40		$(16.7\% \times \pi \times I_{T(AV)} < I < \pi \times I_{T(AV)}, T_J = T_J \text{ max.}$
$V_{T(TO)2}$ High level value of threshold voltage	1.45		$(I > \pi \times I_{T(AV)}, T_J = T_J \text{ max.}$
$r_{t1}$ Low level value of forward slope resistance	0.67	m $\Omega$	$(16.7\% \times \pi \times I_{T(AV)} < I < \pi \times I_{T(AV)}, T_J = T_J \text{ max.}$
$r_{t2}$ High level value of forward slope resistance	0.58		$(I > \pi \times I_{T(AV)}, T_J = T_J \text{ max.}$
$I_H$ Maximum holding current	600	mA	$T_J = 25^\circ\text{C}, I_T > 30A$
$I_L$ Typical latching current	1000		$T_J = 25^\circ\text{C}, V_A = 12V, R_a = 6\Omega, I_G = 1A$

Switching

Parameter	ST183S	Units	Conditions
$di/dt$ Max. non-repetitive rate of rise of turned-on current	1000	A/ $\mu\text{s}$	$T_J = T_J \text{ max}, V_{DRM} = \text{rated } V_{DRM}$ $I_{TM} = 2 \times di/dt$
$t_d$ Typical delay time	1.1	$\mu\text{s}$	$T_J = 25^\circ\text{C}, V_{DM} = \text{rated } V_{DRM}, I_{TM} = 50A \text{ DC}, t_p = 1\mu\text{s}$ Resistive load, Gate pulse: 10V, 5 $\Omega$ source
$t_q$ Max. turn-off time	Min 10 Max 20		$T_J = T_J \text{ max}, I_{TM} = 300A, \text{commutating } di/dt = 20A/\mu\text{s}$ $V_R = 50V, t_p = 500\mu\text{s}, dv/dt: \text{ see table in device code}$

Blocking

Parameter	ST183S	Units	Conditions
$dv/dt$ Maximum critical rate of rise of off-state voltage	500	V/ $\mu\text{s}$	$T_J = T_J \text{ max.}, \text{ linear to } 80\% V_{DRM}, \text{ higher value available on request}$
$I_{RRM}$ $I_{DRM}$ Max. peak reverse and off-state leakage current	40	mA	$T_J = T_J \text{ max}, \text{ rated } V_{DRM}/V_{RRM} \text{ applied}$

Triggering

Parameter	ST183S	Units	Conditions
$P_{GM}$ Maximum peak gate power	60	W	$T_J = T_J \text{ max}, f = 50\text{Hz}, d\% = 50$
$P_{G(AV)}$ Maximum average gate power	10		
$I_{GM}$ Max. peak positive gate current	10	A	$T_J = T_J \text{ max}, t_p \leq 5\text{ms}$
$+V_{GM}$ Maximum peak positive gate voltage	20	V	$T_J = T_J \text{ max}, t_p \leq 5\text{ms}$
$-V_{GM}$ Maximum peak negative gate voltage	5		
$I_{GT}$ Max. DC gate current required to trigger	200	mA	$T_J = T_J \text{ max}, V_A = 12V, R_a = 6\Omega$
$V_{GT}$ Max. DC gate voltage required to trigger	3	V	
$I_{GD}$ Max. DC gate current not to trigger	20	mA	$T_J = T_J \text{ max}, \text{ rated } V_{DRM} \text{ applied}$
$V_{GD}$ Max. DC gate voltage not to trigger	0.25	V	





ST183S Series

Thermal and Mechanical Specifications

Parameter	ST183S	Units	Conditions
$T_J$ Max. junction operating temperature range	-40 to 125	°C	
$T_{stg}$ Max. storage temperature range	-40 to 150		
$R_{thJC}$ Max. thermal resistance, junction to case	0.105	K/W	DC operation
$R_{thCS}$ Max. thermal resistance, case to heatsink	0.04		Mounting surface, smooth, flat and greased
T Mounting torque, $\pm 10\%$	31 (275)	Nm (lbf-in)	Non lubricated threads
	24.5 (210)	Nm (lbf-in)	Lubricated threads
wt Approximate weight	280	g	
Case style	TO-209AB (TO-93)		See Outline Table

$\Delta R_{thJC}$  Conduction

(The following table shows the increment of thermal resistance  $R_{thJC}$  when devices operate at different conduction angles than DC)

Conduction angle	Sinusoidal conduction	Rectangular conduction	Units	Conditions
180°	0.016	0.012	K/W	$T_J = T_J \text{ max.}$
120°	0.019	0.020		
90°	0.025	0.027		
60°	0.036	0.037		
30°	0.060	0.060		

Ordering Information Table

**Device Code**

ST	18	3	S	08	P	F	N	0	
①	②	③	④	⑤	⑥	⑦	⑧	⑨	⑩

- 1** - Thyristor
- 2** - Essential part number
- 3** - 3 = Fast turn off
- 4** - S = Compression bonding Stud
- 5** - Voltage code: Code x 100 =  $V_{RRM}$  (See Voltage Ratings table)
- 6** - P = Stud base 3/4" 16UNF-2A  
M = Stud base metric threads M16 x 1.5
- 7** - Reapplied dv/dt code (for  $t_q$  test condition)
- 8** -  $t_q$  code
- 9** - 0 = Eyelet terminals (Gate and Aux. Cathode Leads)  
1 = Fast-on terminals (Gate and Aux. Cathode Leads)  
2 = Flag terminals (For Cathode and Gate Terminals)
- 10** - Critical dv/dt:  
None = 500V/ $\mu$ sec (Standard value)  
L = 1000V/ $\mu$ sec (Special selection)

dv/dt - $t_q$ combinations available					
dv/dt (V/ $\mu$ s)	20	50	100	200	400
10	CN	DN	EN	<b>FN</b> *	HN
12	CM	DM	EM	FM	HM
$t_q$ ( $\mu$ s)	15	CL	DL	EL	<b>FL</b> *
18	CP	DP	EP	FP	HP
20	CK	DK	EK	FK	HK

\*Standard part number.  
All other types available only on request.



ST183S Series

Outline Table

