

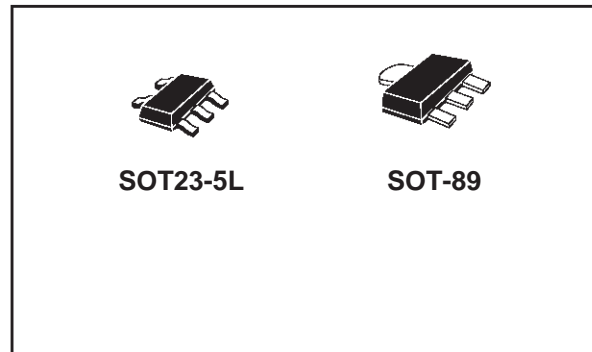

MICROPOWER VFM STEP-UP DC/DC CONVERTER

- VERY LOW SUPPLY CURRENT
- REGULATED OUTPUT VOLTAGE
- WIDE RANGE OF OUTPUT VOLTAGE AVAILABLE (2.5V, 2.8V, 3.0V, 3.3V, 5.0V)
- OUTPUT VOLTAGE ACCURACY $\pm 5\%$
- OUTPUT CURRENT UP TO 100mA
- LOW RIPPLE AND LOW NOISE
- VERY LOW START-UP VOLTAGE
- HIGH EFFICIENCY ($V_{OUT}=5V$ TYP. 87%)
- FEW EXTERNAL COMPONENTS
- VERY SMALL PACKAGE: SOT23-5L, SOT-89



DESCRIPTION

The ST5R00 is an high efficiency VFM Step-up DC/DC converter for small, low input voltage or battery powered systems with ultra low quiescent supply current. The ST5Rxx accept a positive input voltage from start-up voltage to V_{OUT} and convert it to a higher output voltage in the 2.5 to 5V range.

The ST5R00 combine ultra low quiescent supply current and high efficiency to give maximum battery life. The high switching frequency and the internally limited peak inductor current, permits the use of small, low cost inductors. Only three external components are needed: an inductor a diode and an output capacitor.

The ST5R00 is suitable to be used in a battery powered equipment where low noise, low ripple and ultra low supply current are required. The ST5R00 is available in very small packages: SOT23-5L, SOT-89.

Typical applications are pagers, cameras & video camera, cellular telephones, wireless telephones, palmtop computer, battery backup supplies, battery powered equipment.

SCHEMATIC DIAGRAM

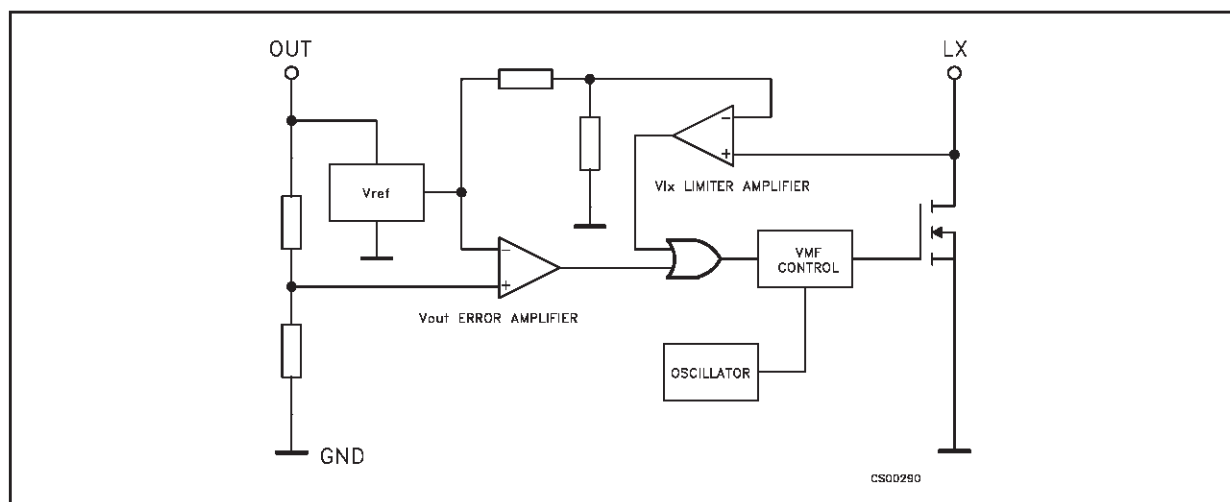

ABSOLUTE MAXIMUM RATING

Symbol	Parameter	Value	Unit
V _{OUT}	Output Voltage	5.5	V
V _{IN}	Input Voltage	5.5	V
V _{LX}	LX Pin Voltage	5.5	V
I _{LX}	LX Pin Output Current	Internally limited	
P _{tot}	Power Dissipation @ 25°C for SOT23-5L	170 (*)	mW
T _{stg}	Storage Temperature Range	- 55 to 125	°C
T _{op}	Operating Junction Temperature Range	- 25 to 85	°C

(*) Reduced by 1.7 mW for increasing in T_A of 1°C over 25°C

THERMAL DATA

Symbol	Parameter	SOT23-5L	SOT-89	Unit
R _{thj-case}	Thermal Resistance Junction-case	63	17	°C/W

OPERATION

The ST5Rxx architecture is built around a VFM CONTROL logic core: switching frequency is set through a built in oscillator: T_{ON} time is fixed (Typ. 5µs) while T_{OFF} time is determined by the error amplifier output, a logic signal coming from the comparison made by the Error Amplifier Stage between the signal coming from the output voltage divider network and the internal Band-Gap voltage reference (V_{ref}). T_{OFF} reaches a minimum (Typ. 1.7µs) when heavy load conditions are met (Clock frequency 150KHz). An over current conditions, through the internal power switch, causes a voltage drop V_{LX}=R_{DS(on)}I_{sw} and the V_{LX} limiter block forces the internal switch to be off, so narrowing T_{ON} time and limiting internal power dissipation. In this

case the switching frequency may be higher than the 150KHz set by the internal clock generator.

VFM control ensures very low quiescent current and high conversion efficiency even with very light loads.

Since the Output Voltage pin is also used as the device Supply Voltage, the versions with higher output voltage present an higher internal supply voltage that results in lower power switch R_{DS(on)}, slightly greater output power and higher efficiency. Moreover, bootstrapping allows the input voltage to sag to 0.6V (at I_{OUT}=1mA) once the system is started.

If the input voltage exceeds the output voltage, the output will follow the input, however, the input or output voltage must not be forced above 5.5V.

Typical Application Circuit

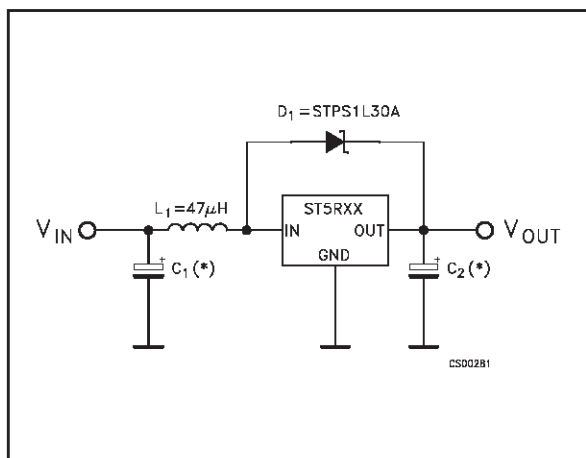

(*) See application info

Typical Application Efficiency

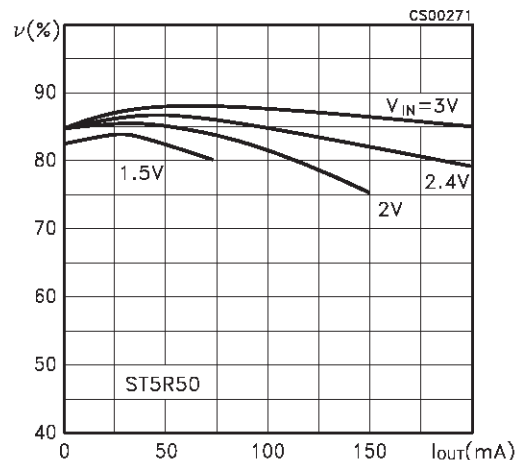

CONNECTION DIAGRAM (top view)

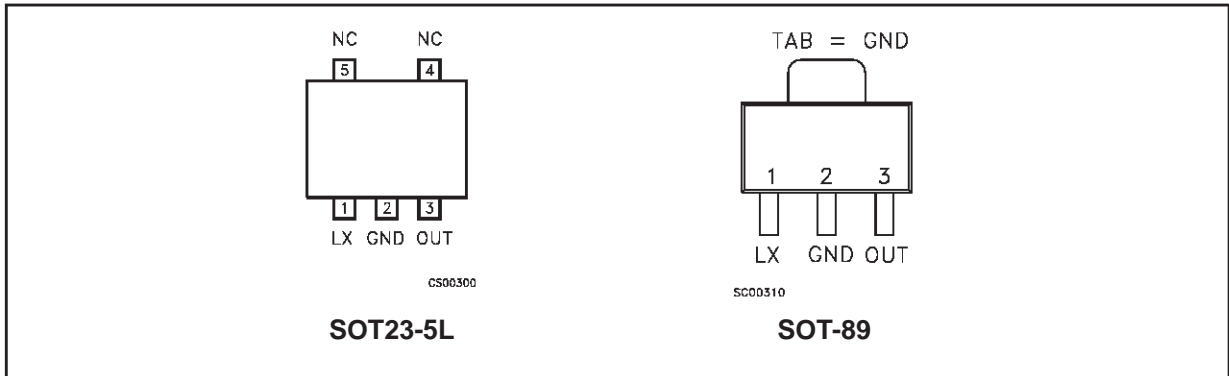

ORDERING NUMBERS

SOT23-5L	SOT-89	Output Voltage
ST5R25M	ST5R25U	2.5 V
ST5R28M	ST5R28U	2.8 V
ST5R30M	ST5R30U	3.0 V
ST5R33M	ST5R33U	3.3 V
ST5R50M	ST5R50U	5.0 V

TYPICAL DEMOBOARD

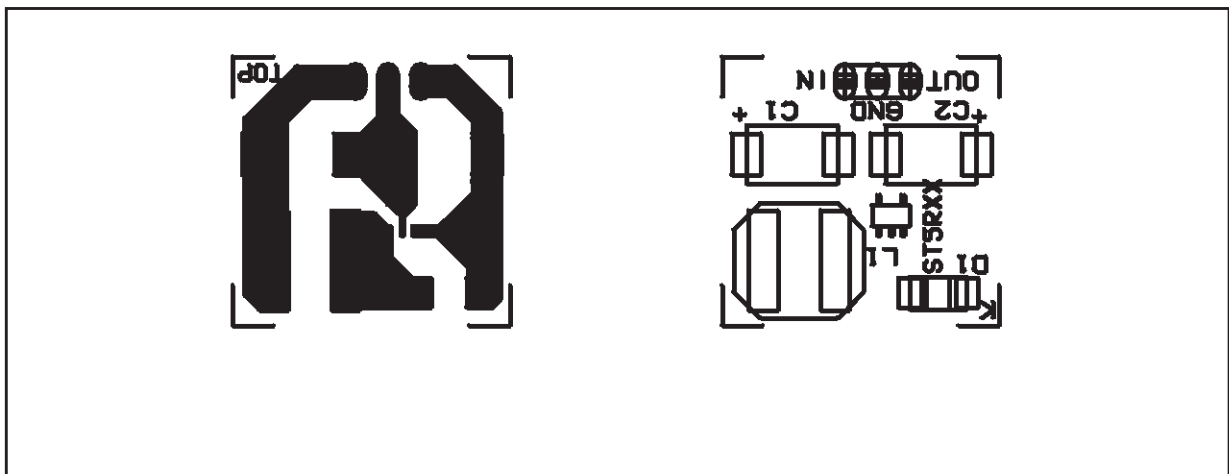

ELECTRICAL CHARACTERISTICS FOR ST5R25

($V_{IN} = 1.5V$, $I_{OUT} = 10mA$ $T_A = 25^{\circ}C$ unless otherwise specified. For external components value, unless otherwise notes, refer to the typical operating circuit.

Symbol	Parameter	Test Conditions	Min.	Typ.	Max.	Unit
V_{OUT}	Output Voltage		2.375	2.5	2.625	V
$V_{START-UP}$	Start-up Voltage ($V_{IN}-V_F$) (1)	$I_{OUT}=1mA$ V_{IN} rising from 0 to 2V		0.8	1.2	V
V_{HOLD}	Hold-on Voltage	$I_{OUT}=1mA$ V_{IN} falling from 2 to 0V	0.6			V
I_{SUPPLY}	Supply Current	To be measured at V_{IN} , no load		16		μA
$R_{LX(DSON)}$	Internal Switch R_{DSON}	$I_{LX}=150mA$		850		$m\Omega$
$I_{LX(leak)}$	Internal Leakage Current	$V_{LX}=4V$, forced $V_{OUT}=3V$			0.5	μA
F_{osc}	Maximum oscillator Frequency			150		kHz
Dty	Oscillator Duty Cycle	to be measure on Lx pin		77		%
η	Efficiency	$I_{OUT}=50mA$		82		%

(1): The minimum input voltage for the IC start-up is strictly a function of the V_F catch diode.

ELECTRICAL CHARACTERISTICS FOR ST5R28

($V_{IN} = 1.7V$, $I_{OUT} = 10mA$ $T_A = 25^{\circ}C$ unless otherwise specified. For external components value, unless otherwise notes, refer to the typical operating circuit.

Symbol	Parameter	Test Conditions	Min.	Typ.	Max.	Unit
V_{OUT}	Output Voltage		2.66	2.8	2.94	V
$V_{START-UP}$	Start-up Voltage ($V_{IN}-V_F$) (1)	$I_{OUT}=1mA$ V_{IN} rising from 0 to 2V		0.8	1.2	V
V_{HOLD}	Hold-on Voltage	$I_{OUT}=1mA$ V_{IN} falling from 2 to 0V	0.6			V
I_{SUPPLY}	Supply Current	To be measured at V_{IN} , no load		16		μA
$R_{LX(DSON)}$	Internal Switch R_{DSON}	$I_{LX}=150mA$		850		$m\Omega$
$I_{LX(leak)}$	Internal Leakage Current	$V_{LX}=4V$, forced $V_{OUT}=3.3V$			0.5	μA
F_{osc}	Maximum oscillator Frequency			150		kHz
Dty	Oscillator Duty Cycle	to be measure on Lx pin		77		%
η	Efficiency	$I_{OUT}=50mA$		82		%

(1): The minimum input voltage for the IC start-up is strictly a function of the V_F catch diode.

ELECTRICAL CHARACTERISTICS FOR ST5R30

($V_{IN} = 1.8V$, $I_{OUT} = 10mA$ $T_A = 25^{\circ}C$ unless otherwise specified. For external components value, unless otherwise notes, refer to the typical operating circuit.

Symbol	Parameter	Test Conditions	Min.	Typ.	Max.	Unit
V_{OUT}	Output Voltage		2.85	3	3.15	V
$V_{START-UP}$	Start-up Voltage ($V_{IN}-V_F$) (1)	$I_{OUT}=1mA$ V_{IN} rising from 0 to 2V		0.8	1.2	V
V_{HOLD}	Hold-on Voltage	$I_{OUT}=1mA$ V_{IN} falling from 2 to 0V	0.6			V
I_{SUPPLY}	Supply Current	To be measured at V_{IN} , no load		17		μA
$R_{LX(DSON)}$	Internal Switch R_{DSON}	$I_{LX}=150mA$		850		$m\Omega$
$I_{LX(leak)}$	Internal Leakage Current	$V_{LX}=4V$, forced $V_{OUT}=3.5V$			0.5	μA
F_{osc}	Maximum oscillator Frequency			150		kHz
Dty	Oscillator Duty Cycle	to be measure on Lx pin		77		%
η	Efficiency	$I_{OUT}=50mA$		83		%

(1): The minimum input voltage for the IC start-up is strictly a function of the V_F catch diode.

ELECTRICAL CHARACTERISTICS FOR ST5R33

($V_{IN} = 2V$, $I_{OUT} = 10mA$, $T_A = 25^{\circ}C$ unless otherwise specified. For external components value, unless otherwise notes, refer to the typical operating circuit.

Symbol	Parameter	Test Conditions	Min.	Typ.	Max.	Unit
V_{OUT}	Output Voltage		3.135	3.3	3.465	V
$V_{START-UP}$	Start-up Voltage ($V_{IN}-V_F$) (1)	$I_{OUT}=1mA$ V_{IN} rising from 0 to 2V		0.8	1.2	V
V_{HOLD}	Hold-on Voltage	$I_{OUT}=1mA$ V_{IN} falling from 2 to 0V	0.6			V
I_{SUPPLY}	Supply Current	To be measured at V_{IN} , no load		17		μA
$R_{LX(DSON)}$	Internal Switch R_{DSON}	$I_{LX}=150mA$		850		$m\Omega$
$I_{LX(leak)}$	Internal Leakage Current	$V_{LX}=4V$, forced $V_{OUT}=3.8V$			0.5	μA
F_{osc}	Maximum oscillator Frequency			150		kHz
Dty	Oscillator Duty Cycle	to be measure on Lx pin		77		%
η	Efficiency	$I_{OUT}=50mA$		83		%

(1): The minimum input voltage for the IC start-up is strictly a function of the VF catch diode.

ELECTRICAL CHARACTERISTICS FOR ST5R50

($V_{IN} = 3V$, $I_{OUT} = 10mA$, $T_A = 25^{\circ}C$ unless otherwise specified. For external components value, unless otherwise notes, refer to the typical operating circuit.

Symbol	Parameter	Test Conditions	Min.	Typ.	Max.	Unit
V_{OUT}	Output Voltage		4.75	5.0	5.25	V
$V_{START-UP}$	Start-up Voltage ($V_{IN}-V_F$) (1)	$I_{OUT}=1mA$ V_{IN} rising from 0 to 2V		0.8	1.2	V
V_{HOLD}	Hold-on Voltage	$I_{OUT}=1mA$ V_{IN} falling from 2 to 0V	0.6			V
I_{SUPPLY}	Supply Current	To be measured at V_{IN} , no load		18		μA
$R_{LX(DSON)}$	Internal Switch R_{DSON}	$I_{LX}=150mA$		700		$m\Omega$
$I_{LX(leak)}$	Internal Leakage Current	$V_{LX}=4V$, forced $V_{OUT}=5.5V$			0.5	μA
F_{osc}	Maximum oscillator Frequency			160		kHz
Dty	Oscillator Duty Cycle	to be measure on Lx pin		77		%
η	Efficiency	$I_{OUT}=50mA$		87		%

(1): The minimum input voltage for the IC start-up is strictly a function of the VF catch diode.

TYPICAL OPERATING CHARACTERISTICS (the following plots are referred to the typical application circuit and, unless otherwise noted, at $T_A=25^{\circ}C$)

Figure 1: Output Voltage vs Output Current

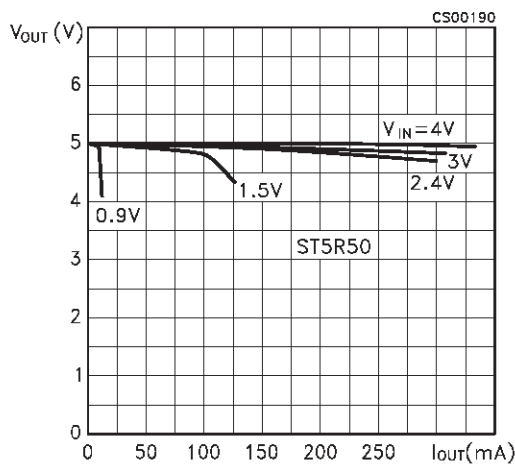

Figure 2: Output Voltage vs Output Current

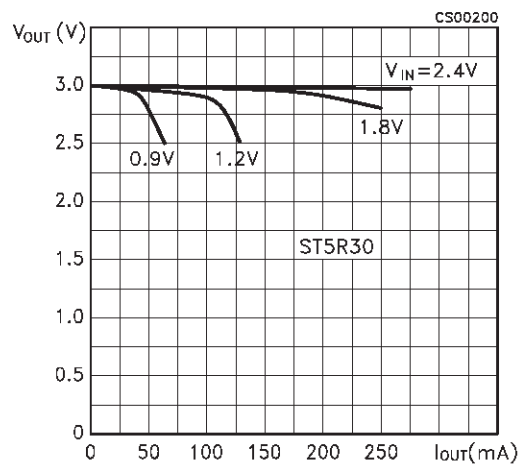

Figure 3: Output Voltage vs Temperature

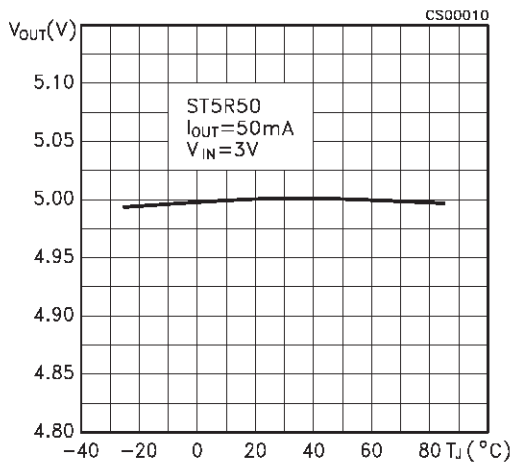

Figure 4: Output Voltage vs Temperature

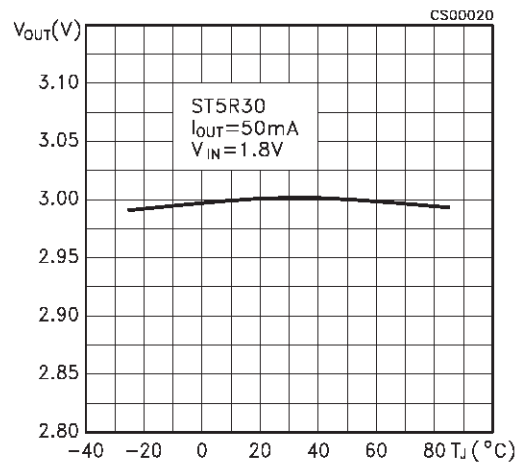

Figure 5: Efficiency vs Temperature

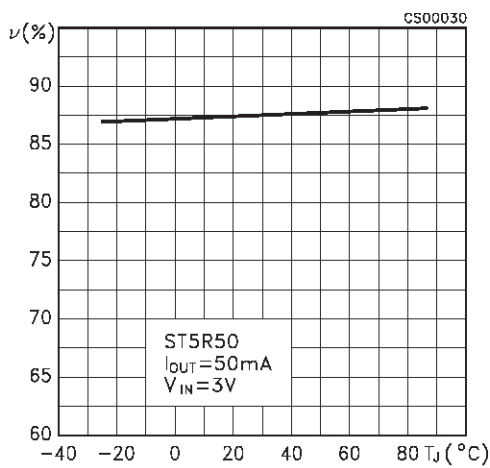

Figure 6: Efficiency vs Temperature

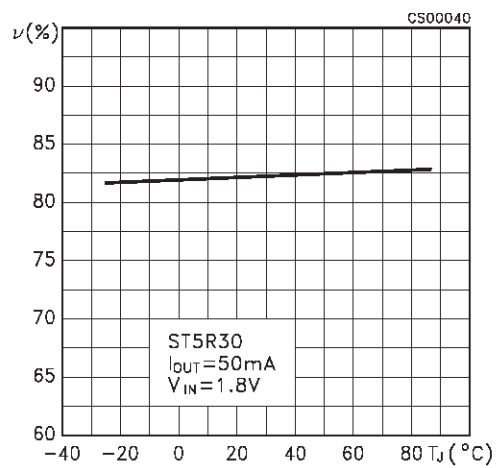

Figure 7: Efficiency vs Output Current

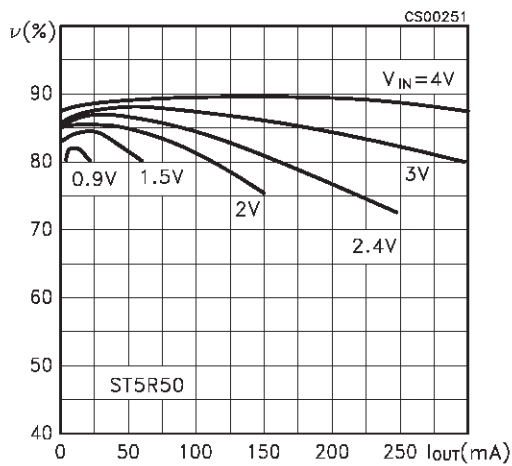

Figure 8: Efficiency vs Output Current

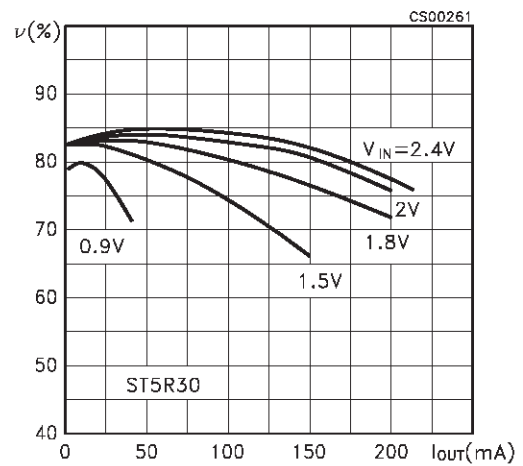

Figure 9: Maximum Oscillator Frequency vs Temperature

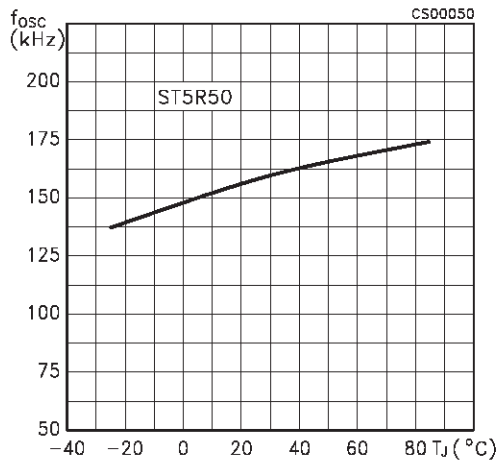

Figure 10: Maximum Oscillator Frequency vs Temperature

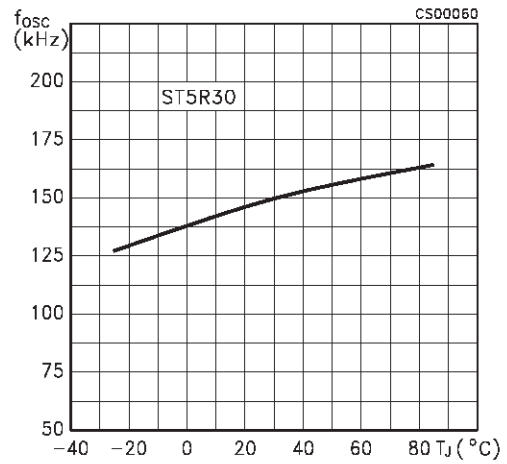

Figure 11: Oscillator Duty Cycle (@ MAX Freq.) vs Temperature

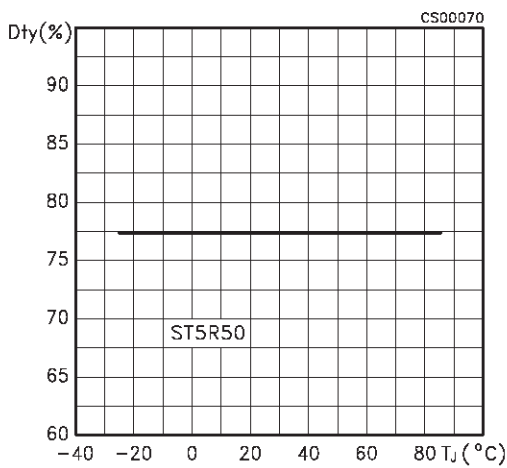

Figure 12: Oscillator Duty Cycle (@ MAX Freq.) vs Temperature

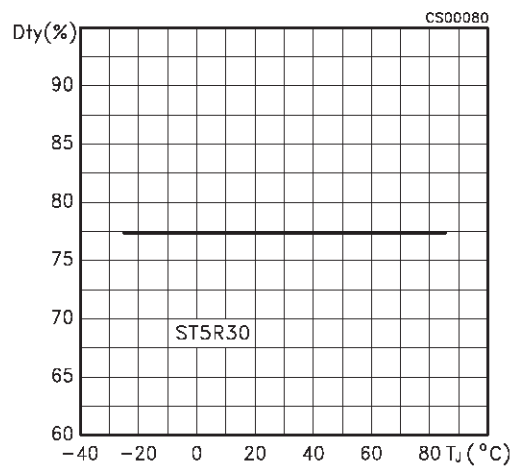

Figure 13: Lx Switching Current Limit vs Temperature

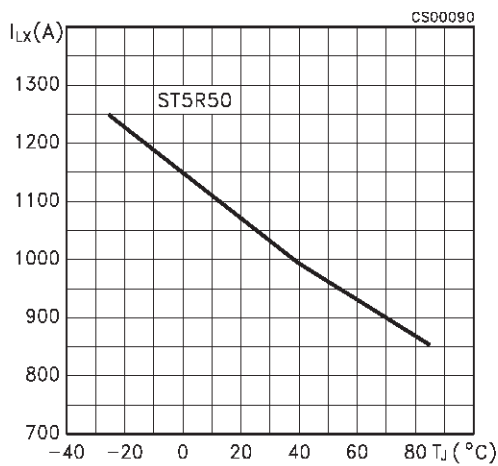

Figure 14: Lx Switching Current Limit vs Temperature

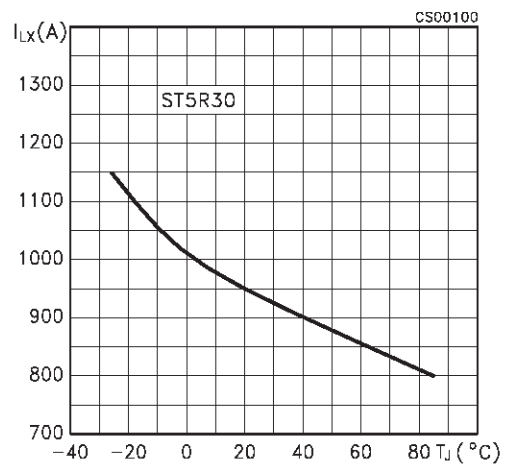
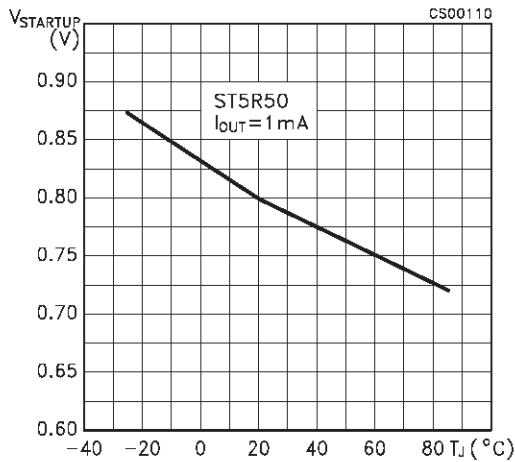
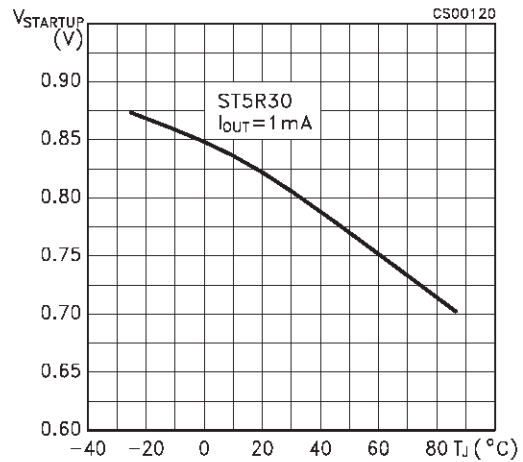

Figure 15: Start-up Voltage ($V_{IN}-V_F$) vs Temperature



(*) Input Voltage less the voltage drop across the diode

Figure 16: Start-up Voltage ($V_{IN}-V_F$) vs Temperature



(*) Input Voltage less the voltage drop across the diode

Figure 17: Start-up Voltage ($V_{IN}-V_F$) vs Output Current

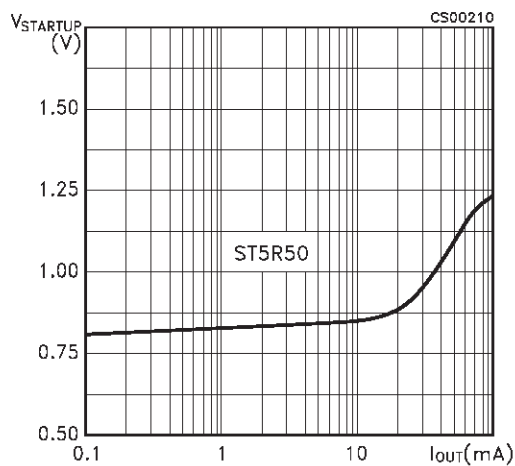

(*) Input Voltage less the voltage drop across the diode

Figure 18: Start-up Voltage ($V_{IN}-V_F$) vs Output Current

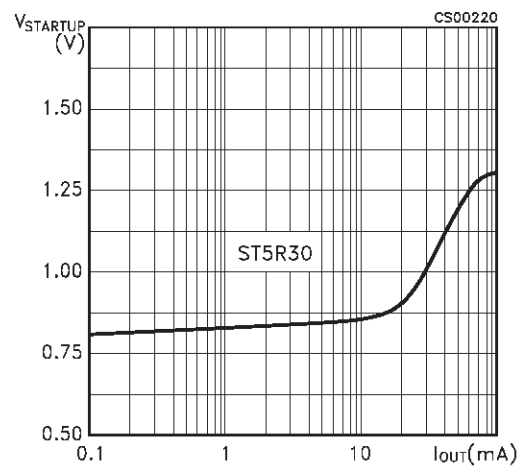

(*) Input Voltage less the voltage drop across the diode

Figure 19: Minimum Input Voltage vs Output Current

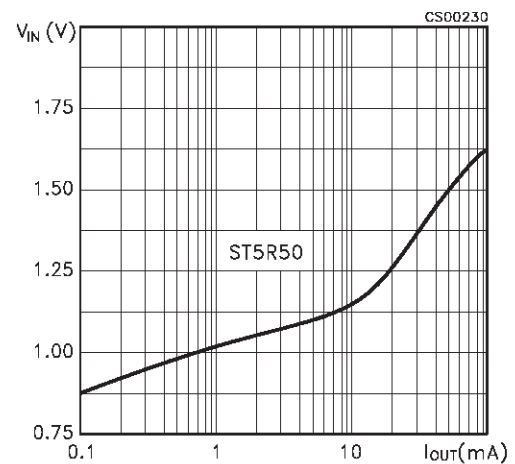

Figure 20: Minimum Input Voltage vs Output Current

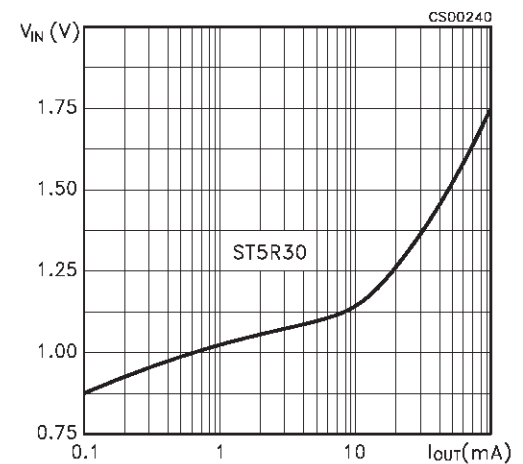

Figure 21: Internal Switch $R_{DS(ON)}$ vs Temperature

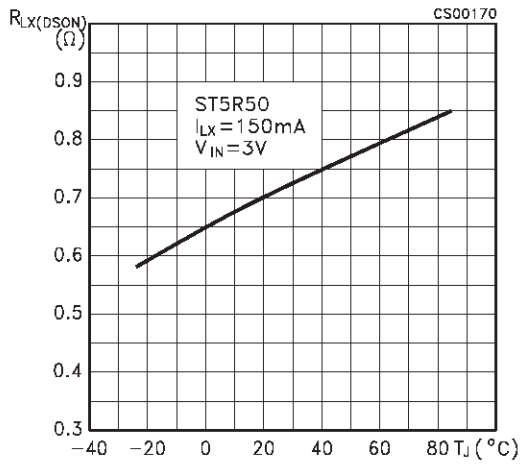

Figure 22: Internal Switch $R_{DS(ON)}$ vs Temperature

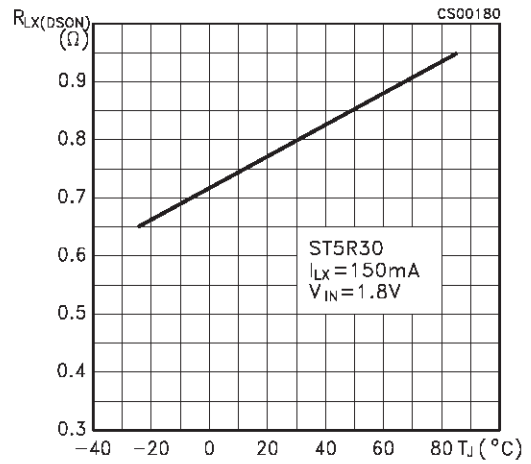

Figure 23: Hold-on Voltage vs Temperature

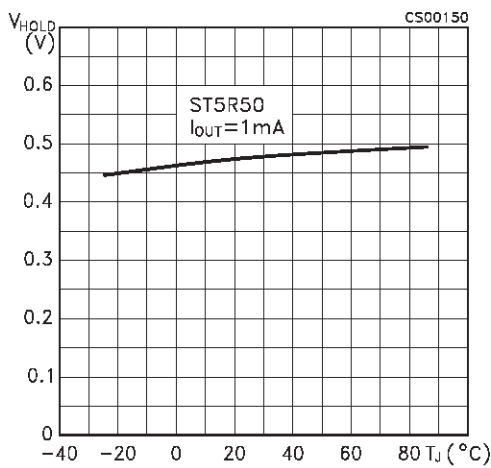

Figure 24: Hold-on Voltage vs Temperature

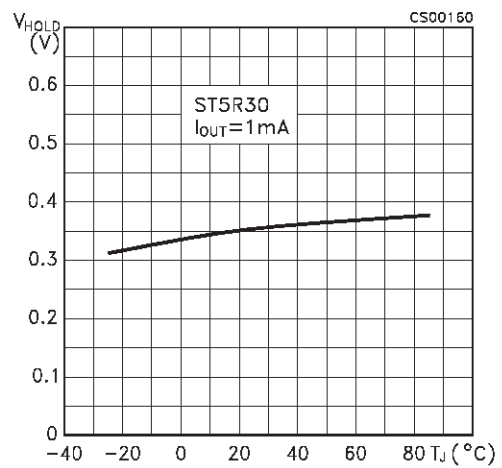

Figure 25: No Load Input Current vs Temperature

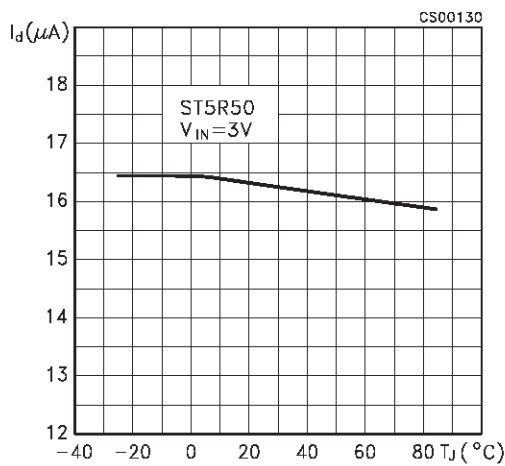
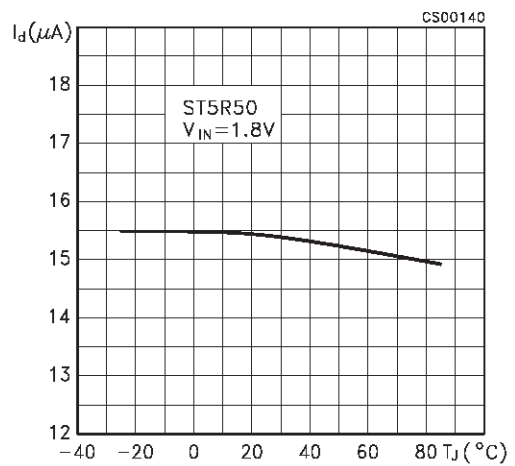

Figure 26: No Load Input Current vs Temperature



APPLICATION INFORMATION

PC LAYOUT AND GROUNDING HINTS

The ST5R00 high frequency operation makes PC layout important for minimizing ground bounce and noise. Place external components as close as possible to the device pins. Take care to the Supply Voltage Source connections that have to be very close to the Input of the application. Set the Output Load as close as possible to the output capacitor. If possible, use a Star ground connection with the centre point on the Device Ground pin. To maximize output power and efficiency and minimize output ripple voltage, use a ground plane and solder the ICs ground pin directly to the ground plane.

Remember that the LX Switching Current flows through the Ground pin, so, in order to minimize the series resistance that may cause power dissipation and decrease of the Efficiency conversion, the Ground pattern has to be as large as possible.

INDUCTOR SELECTION

An inductor value of 47µH performs well in most ST5R00 applications. However, the inductance value is not critical, and the ST5R00 will work with inductors in the 33µH to 120µH. Smaller inductance values typically offer a smaller physical size for a given series resistance, allowing the smallest overall circuit dimensions. However, due to higher peak inductor currents, the output voltage ripple ($I_{peak} \times$ output filter capacitors ESR) also tends to be higher. Circuits using larger inductance values exhibit higher output current capability and larger physical dimensions for a given series resistance.

In order to obtain the best application performances the inductor must respect the following condition:

- The DC resistance has to be as little as possible, a good value is $<0.25\Omega$. This choice will reduce the lost power as heat in the windings.

- The inductor core must not saturate at the forecast maximum LX current. This is mainly a function of the Input Voltage, Inductor value and Output Current. However, it is generally acceptable to bias the inductor into saturation by as much as 20%, although this will slightly reduce efficiency. In order to calculate this parameter we have to distinguish two cases:

1) When a light load is applied on the output (discontinuous mode operation) the inductor core must not saturate at

$$I_{LX(max)} = (V_{IN} \times T_{ON})/L.$$

2) For heavy load (continuous mode operation) the

inductor core must not saturate at

$$I_{LX(max)} = (I_{OUT} \times T)/T_{OFF(min)} + (V_{IN} \times T_{ON})/2L$$

Where: V_{IN} is the Input Voltage, T_{ON} is the switch on period (typ. 5µs), L is the inductance value, I_{OUT} is the maximum forecast

Output Current, $T = T_{ON} + T_{OFF(min)}$ and $T_{OFF(min)}$ is the minimum switch off period (typ. 1.7µs),

- Choose an inductance value in the 47µH to 82µH range.

- For application sensitive to Electromagnetic Interference (EMI), a pot core inductor is recommended.

DIODE SELECTION

A Schottky diode with an high switching speed and a very low Forward Voltage (V_F) is needed. Higher V_F may cause lost power as heat in the diode, with a decrease of the Efficiency. Moreover, since the Output Voltage pin is also used as the device Supply Voltage, the Start-up Voltage (see related plots) is strictly due to the diode Forward Voltage at the rated Forward Current. A good diode choice is a STPS1L30A (STM).

INPUT/OUTPUT CAPACITORS SELECTION

The Output Ripple Voltage, as well as the Efficiency, is strictly related to the behaviour of these elements. The output ripple voltage is the product of the peak inductor current and the output capacitor Equivalent Series Resistance (ESR). Best performances are obtained with good high frequency characteristics capacitors and low ESR. The best compromise for the value of the Output Capacitance is 47µF Tantalum Capacitor. Lower values may cause higher Output Ripple Voltage and lower Efficiency without compromising the functionality of the device.

An Input Capacitor is required to compensate, if present, the series impedance between the Supply Voltage Source and the Input Voltage of the Application.

A value of 4.7µF is enough to guarantee stability for distances less than 2". It could be necessary (depending on V_{IN} , V_{OUT} , I_{OUT} values) to proportionally increase the input capacitor value up to 100µA for major distances.

In any case we suggest to connect both capacitors, C_{IN} and C_{OUT} , as close as possible to the device pins.

SOT-89 MECHANICAL DATA

DIM.	mm			mils		
	MIN.	TYP.	MAX.	MIN.	TYP.	MAX.
A	1.4		1.6	55.1		63.0
B	0.44		0.56	17.3		22.0
B1	0.36		0.48	14.2		18.9
C	0.35		0.44	13.8		17.3
C1	0.35		0.44	13.8		17.3
D	4.4		4.6	173.2		181.1
D1	1.62		1.83	63.8		72.0
E	2.29		2.6	90.2		102.4
e	1.42		1.57	55.9		61.8
e1	2.92		3.07	115.0		120.9
H	3.94		4.25	155.1		167.3
L	0.89		1.2	35.0		47.2

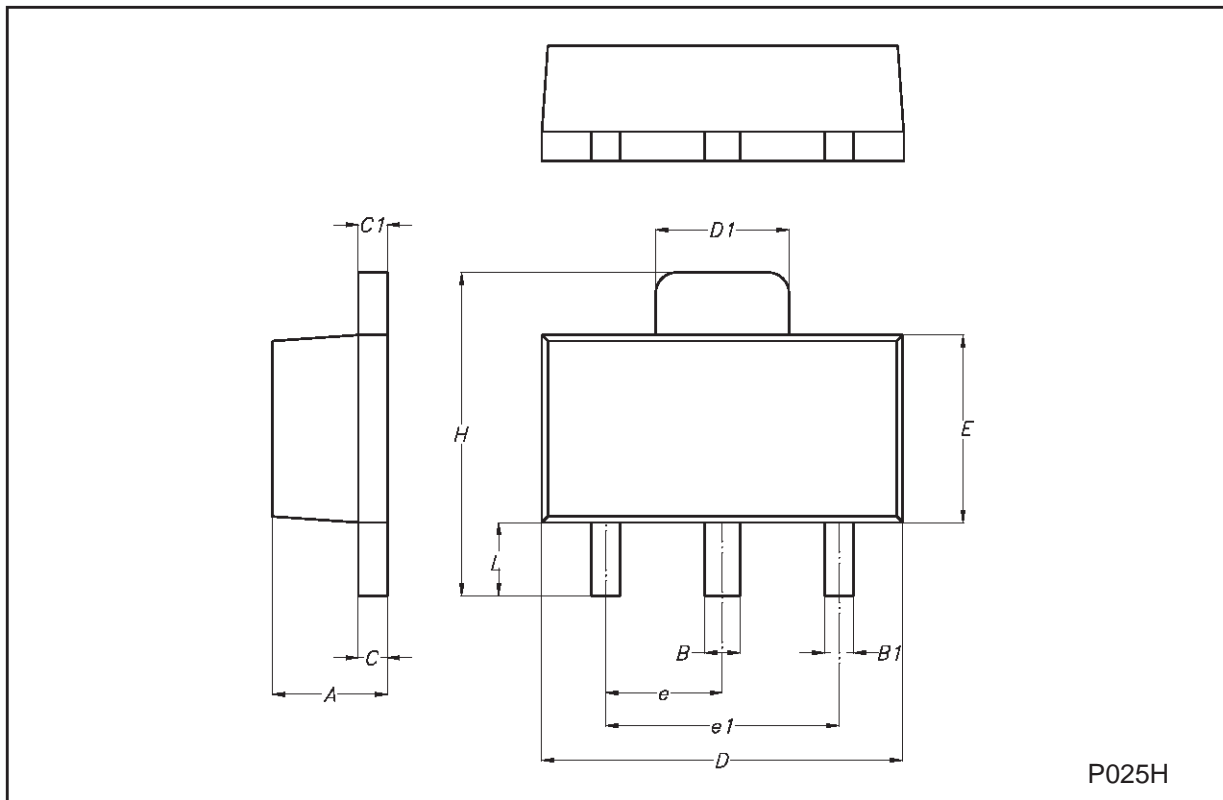

SOT23-5L MECHANICAL DATA

DIM.	mm			mils		
	MIN.	TYP.	MAX.	MIN.	TYP.	MAX.
A	0.90		1.45	35.4		57.1
A1	0.00		0.15	0.0		5.9
A2	0.90		1.30	35.4		51.2
b	0.35		0.50	13.7		19.7
C	0.09		0.20	3.5		7.8
D	2.80		3.00	110.2		118.1
E	2.60		3.00	102.3		118.1
E1	1.50		1.75	59.0		68.8
L	0.35		0.55	13.7		21.6
e		0.95			37.4	
e1		1.9			74.8	

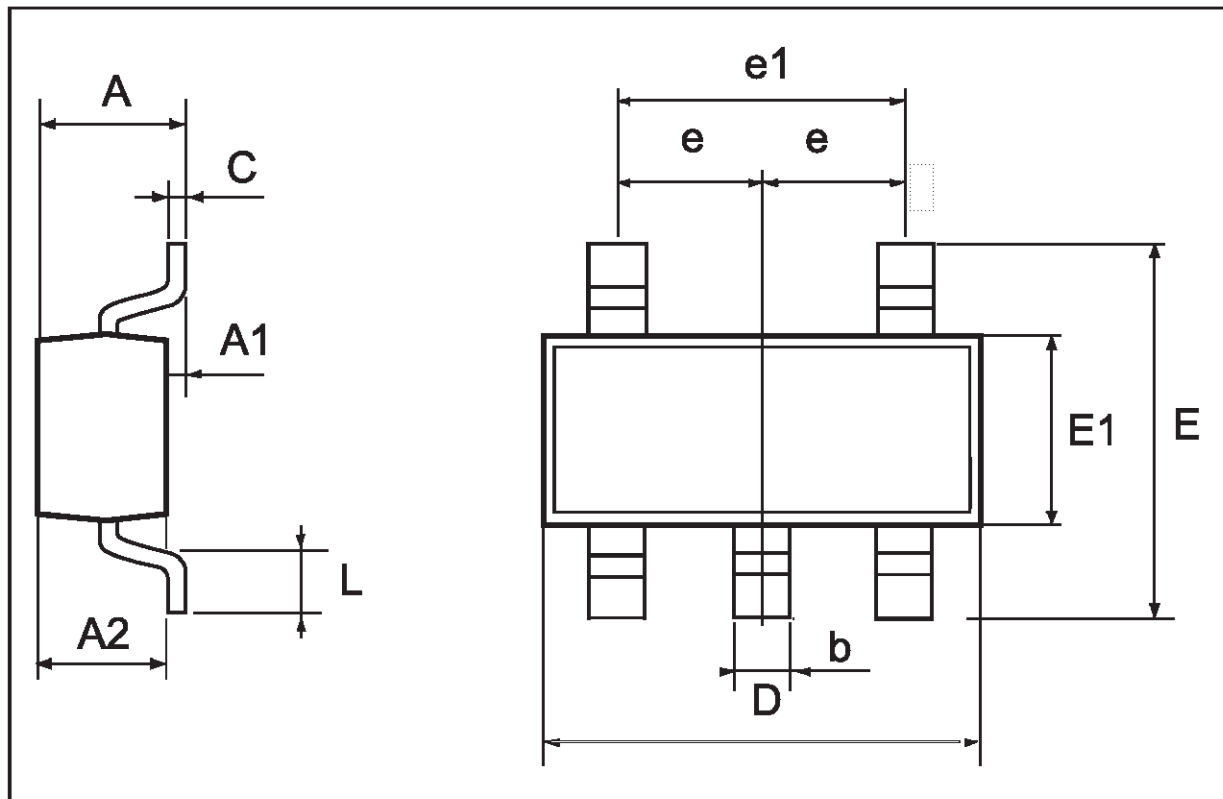

Information furnished is believed to be accurate and reliable. However, STMicroelectronics assumes no responsibility for the consequences of use of such information nor for any infringement of patents or other rights of third parties which may result from its use. No license is granted by implication or otherwise under any patent or patent rights of STMicroelectronics. Specification mentioned in this publication are subject to change without notice. This publication supersedes and replaces all information previously supplied. STMicroelectronics products are not authorized for use as critical components in life support devices or systems without express written approval of STMicroelectronics.

The ST logo is a registered trademark of STMicroelectronics

© 2001 STMicroelectronics – Printed in Italy – All Rights Reserved

STMicroelectronics GROUP OF COMPANIES

Australia - Brazil - China - Finland - France - Germany - Hong Kong - India - Italy - Japan - Malaysia - Malta - Morocco
Singapore - Spain - Sweden - Switzerland - United Kingdom - U.S.A.

<http://www.st.com>