

CT2 RECEIVER/TRANSMITTER

ADVANCE DATA

- FULLY INTEGRATED DOUBLE SUPERHETERODYNE RECEIVER
- OPERATION FROM 800MHz TO 1000MHz
- RECEIVER OUTPUT AS BITSTREAM
- FULLY INTEGRATED TRANSMITTER
- TRANSMITTER INPUT I/Q/REFIQ OR I/I , Q/Q
- INTEGRATED POWER AMPLIFIER
- CT2 PA SWITCH-ON PROFILE INTEGRATED
- VCO's INTEGRATED
- SYNTHESIZERS INTEGRATED
- CHANNEL SELECT LOGIC ON CHIP
- INTEGRATED VOLTAGE REGULATION
- SUPPLY VOLTAGES FROM 3.0V TO 5.5V

DESCRIPTION

The STB4395(A) is a fully integrated receiver-transmitter designed for CT2 applications, and incorporates all the VCO's, synthesizers, PLLs, and channel select logic, to make a fully functional "single chip" radio.

The receiver is of the double superhet architecture and operates from an aerial input (via a SAW filter) to bitstream output to CT2 format, whilst the transmitter operates from I/Q inputs to +13dBm at the final frequency. A single (external) frequency reference is all that is required to give full coverage over the range of 800 to 1000MHz. The on-off slope of the Transmit PA is governed internally to give the required switch-on ramp, whilst the output can be switched from low to high power by means of an external digital control signal.

The channelselect is controlled from a digital serial input, and allows continuous channel control from 800 to 1000MHz.

The STB4395 exists in two versions: the STB4395, which has I/I , Q/Q transmit data input/outputs, is designed to operate with the SGS-THOMSON baseband companion part, the ST5095. The STB4395A has a 3 wire I/Q interface and is compatible with commercially available I/Q transmit data baseband IC's.

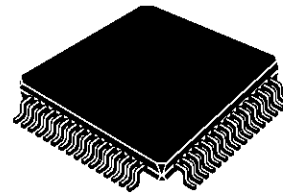

TQFP64
(Plastic Package)

ORDER CODE : STB4395 or STB4395A

CONTENT		Page
1	PIN DESCRIPTION	3
1.1	PIN CONNECTIONS	4
1.2	PIN LIST	5
1.3	ANALOG AND FILTER PINS	5
1.4	DIGITAL, SIGNAL AND CONTROL PINS	6
1.5	POWER SUPPLY PINS	6
2	BLOCK DIAGRAM	7
3	FUNCTIONAL DESCRIPTION	8
3.1	RECEIVER	8
3.2	TRANSMITTER	8
3.3	CHANNEL SELECT CONTROL LOGIC	8
4	ABSOLUTE MAXIMUM RATINGS	8
5	POWER SUPPLIES	9
5.1	SUPPLIES	9
5.2	GROUND PLANE CONNECTIONS	9
6	ELECTRICAL CHARACTERISTICS	9
7	TIMING INFORMATION	9
7.1	TURN ON-OFF TIMES	9
7.2	CHANNEL SELECT TIMING	9
8	TRANSCEIVER SECTION	10
8.1	RECEIVER-INPUT SPECIFICATION	10
8.2	TRANSMITTER OUTPUT SPECIFICATION	11
8.3	SYNTHESIZER/MODULATOR/CHANNEL SELECT LOOP	11
8.3.1	Synthesizer phase noise and spurious	11
8.3.2	Channel select loop	11
8.3.3	Channel frequency setting	12
8.4	SYSTEM CLOCK INPUT	13
8.5	RECEIVER -RF INPUT	13
8.6	DIGITAL INPUT BUFFERS	13
8.7	DIGITAL OUTPUT BUFFERS	13
8.8	RECEIVER- FSH TRI STATE INPUT	13
8.9	RECEIVER- RSSI OUTPUT	14
8.10	POWER DOWN BUFFER	14
8.11	TRANSMITTER - DATA INPUTS	14
8.11.1	STB4395A	14
8.11.2	STB4395	14
9	APPLICATIONS	15
9.1	TYPICAL DC CONNECTION SCHEMES	15
9.1.1	Internal regulator	15
9.1.2	External regulator	15
9.2	APPLICATION CIRCUIT	15
9.2.1	Introduction	15
9.2.2	Application example	15
10	PACKAGE MECHANICAL DATA	16

1 - PIN DESCRIPTION

1.1 - Pin Connections

STB4395

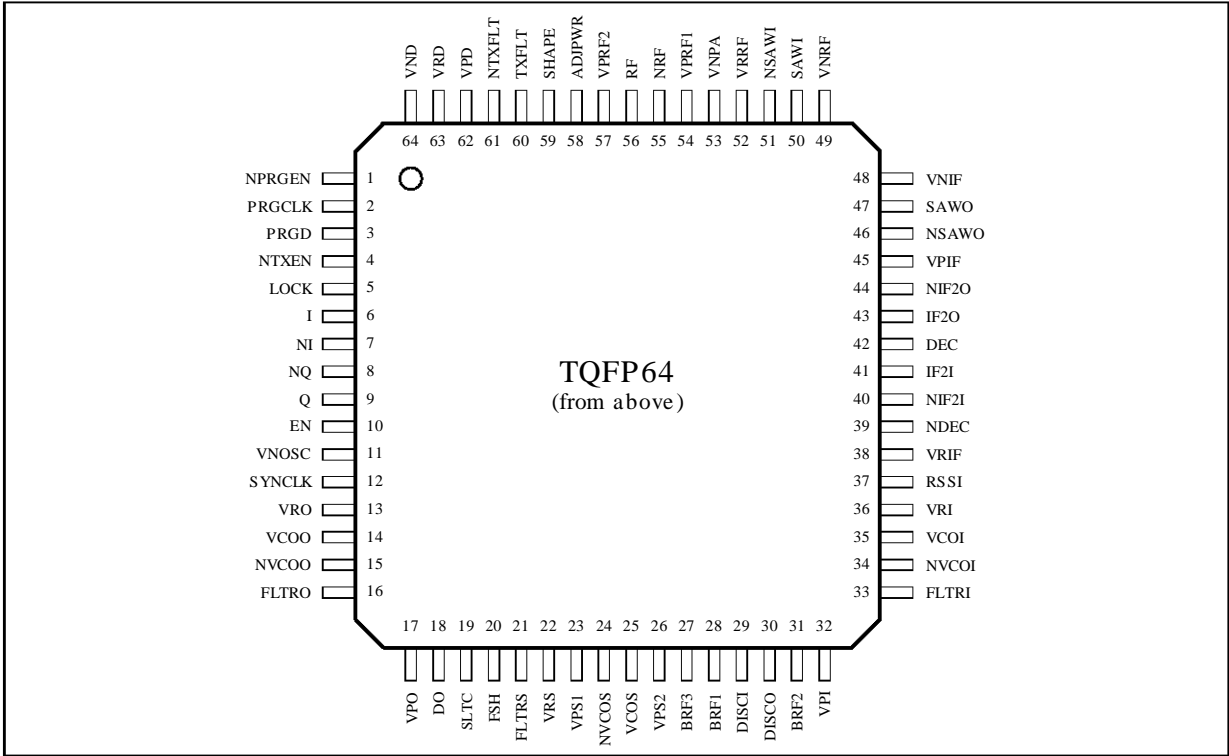

4395-01.EPS

STB4395A

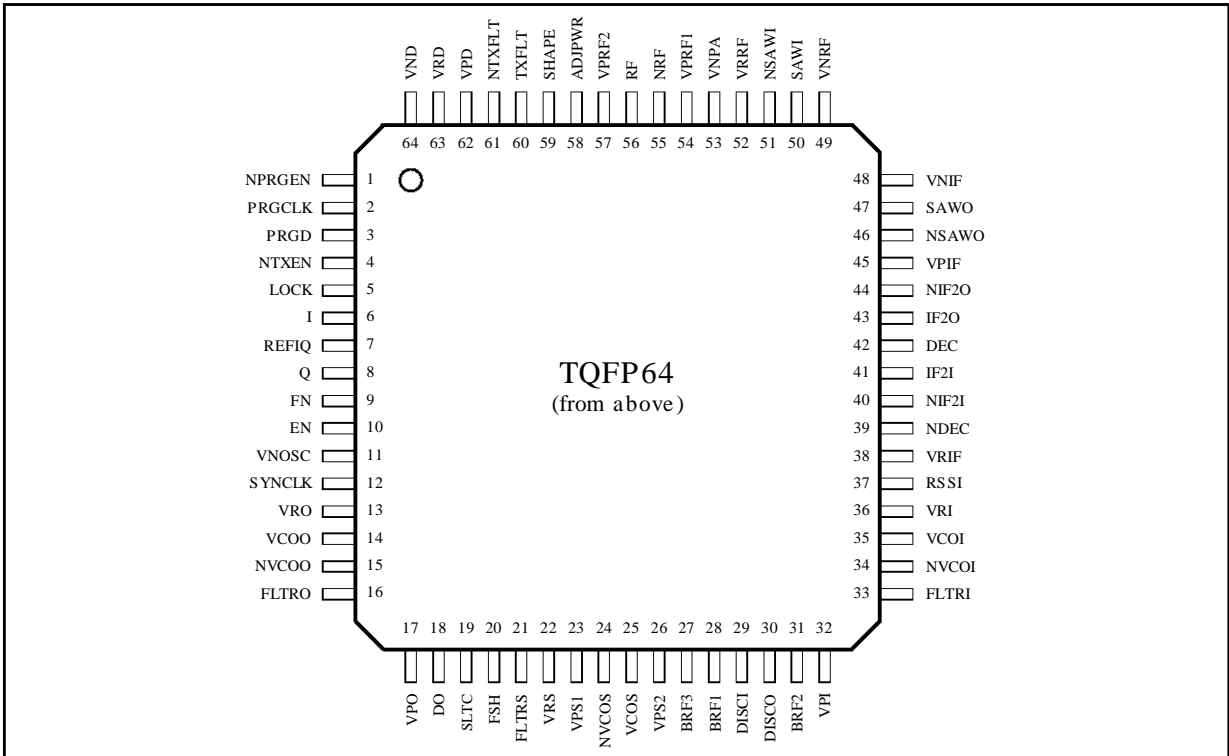

4395-02.EPS

STB4395

1 - PIN DESCRIPTION (continued)

1.2 - Pin List

Pin	Name	Description	Ext. Connection and Suppl. Information
1	NPRGEN	Serial Data Enable	
2	PRGCLK	Serial Data Clock	
3	PRGD	Serial Data Input	
4	NTXEN	Receive-Transmit Switch	
5	LOCK	VCO Lock Detect-all 3 PLL	
6	I	I - Transmit Quadrature Input	
7	NI	I - Transmit Quadrature Input	STB4395 only
8	NQ	Q-Transmit Quadrature Input	STB4395 only
9	Q	Q-Transmit Quadrature Input	STB4395 only
7	REFIQ	IQ Reference Quadrature Transmit Input	STB4395A only
8	Q	Q-Transmit Quadrature Input	STB4395A only
9	FN	Forces Data Slicer Reference Time Constant To fast	STB4395A only
10	EN	Power Down all functions except buffer	
11	VNOSC	Negative Power Supply all VCO 's	
12	SYNCLK	Synthesizer Clock Input	f = 14.4MHz A.C. coupled
13	VRO	PSU Regulated Negative Input for TX IF oscillator and pump circuit	
14	VCOO	TX oscillator tank circuit	
15	NVCOO	TX Oscillator Tank Circuit	
16	FLTRO	Loop Filter for TX PLL	
17	VPO	Positive Battery Supply for TX oscillator	
18	DO	Receive Data Output	
19	SLTC	Slicer Time Constant Capacitor	C= 33nF
20	FSH	Data Slicer Time Constant Setting	
21	FLTRS	Loop Filter for channel PLL	
22	VRS	Regulated Negative Supply for channel oscillator and pump circuit	
23	VPS1	Positive Battery Input for channel oscillator and pump circuit	
24	NVCOS	Channel Oscillator Tank Input	650 to 850MHz
25	VCOS	Channel Oscillator Tank Input	650 to 850MHz
26	VPS2	Positive Battery Supply Input for channel oscillator and pump circuit	
27	BRF3	Bit Rate Filter3	
28	BRF1	Bit Rate Filter1	
29	DISCI	FM Discriminator Tank Circuit	
30	DISCO	FM Discriminator Tank Circuit	
31	BRF2	Bit Rate Filter 2	
32	VPI	Positive Battery Supply for RXoscillator and pump circuit	
33	FLTRI	Loop Filter for RX oscillator	
34	NVCOI	RX Oscillator Tank Circuit	
35	VCOI	RX Oscillator Tank Circuit	
36	VRI	Regulated Negative Supply for RX oscillator and pump circuit	
37	RSSI	RSSI OUTPUT	
38	VRIF	Regulated Negative Supply Output for RX sections	
39	NDEC	RX IF2 Decoupling	
40	NIF2I	RX IF2 Filter Input	
41	IF2I	RX IF2 Filter Input	
42	DEC	RX IF2 Decoupling	
43	IF2O	RX IF2 Filter Output	
44	NIF2O	RX IF2 Filter Output	
45	VPIF	Positive Battery Supply Input for RX sections	

1 - PIN DESCRIPTION (continued)**1.2 - Pin List** (continued)

Pin	Name	Description	Ext. Connection and Suppl. Information
46	NSAWO	RX First IF Amplifier Input	
47	SAWO	RX First IF Amplifier Input	
48	VNIF	Negative Battery Supply Input for RX sections	
49	VNRF	Negative Battery Supply Input for RF front end	
50	SAWI	RX First Mixer Output	
51	NSAWI	RX First Mixer Output	
52	VRRF	Regulated Negative Supply for RF front end	
53	VNPA	Negative Supply for power amplifier	
54	VPRF1	Positive Battery Supply for RF front end	
55	NRF	Input LNA/Output PA	
56	RF	Input LNA/Output PA	
57	VPRF2	Positive Battery Supply for RF front end	
58	ADJPWR	Transmit Power Adjust	R = 8.5k Ω to VRRF
59	SHAPE	Time Constant for PA on-off ramp	C = 560pF
60	TXFLT	Bandpass Filter for TX RF	
61	NTXFLT	Bandpass Filter for TX RF	
62	VPD	Positive Battery Supply for digital circuitry	
63	VRD	Regulated Negative Supply for digital circuitry	
64	VND	Negative Battery Supply for digital circuitry	

1.3 - Analog and Filter Pins

Pin	Symbol	Description
58	ADJPWR	Transmitter Output Power Adjust
28	BRF1	Bit Rate Filter1
31	BRF2	Bit Rate Filter 2
27	BRF3	Bit Rate Filter 3
42, 39	DEC, NDEC	RX IF2 Amplifier Decoupling
29	DISCI	FM Discriminator Tank Circuit
30	DISCO	FM Discriminator Tank Circuit
33	FLTRI	Loop Filter for RX PLL
16	FLTRO	Loop Filter for TX PLL
21	FLTRS	Loop Filter for Channel PLL
6, 7	I, NI(1)	Transmit Quadrature Inputs ((1)STB4395 only)
40, 41	IF2I, NIF2I	Inputs from 2nd IF Filter
43, 44	IF2O, NIF2O	Outputs to 2nd IF Filter
8, 9	Q, NQ(1)	Q-Transmit Quadrature Input ((1)STB4395 only)
7	REFIQ	IQ Reference Quadrature Transmit Input (STB4395A only)
56, 55	RF, NRF	Input RX LNA/Output TX PA
37	RSSI	Received Signal Strength Indicator Output
50, 51	SAWI, NSAWI	First Mixer Output
47, 46	SAWO, NSAWO	First IF Amplifier Input
59	SHAPE	Time Constant for PA on-off Ramp
19	SLTC	Slicer Time Constant Capacitor
12	SYNCLK	Synthesizer Clock Input 14.4MHz
60, 61	TXFLT/ NTXFLT	Bandpass Filter for TX RF
35, 34	VCOI, NVCOI	Tank Circuit for 152.1MHz RX Oscillator
14, 15	VCOO, NVCOO	Tank Circuit for 300.8MHz TX Oscillator
25, 24	VCOS, NVCOS	Tank Circuit for 650 to 850MHz Channel Oscillator

1 - PIN DESCRIPTION (continued)

1.4- Digital, Signal and Control Pins

Pin	Symbol	Description	Polarity
18	DO	Receive Data Output	
20	FSH	Data Slicer Time Constant Setting (Fast/Slow/Hold)	High: slow, tri-state: fast, low: hold DO goes high on hold (see next table)
9	FN	Forces Data Slicer Reference Time Constant to fast (STB4395A only)	low: fast (overrides FSH) high: fast, slow or hold (set by FSH)
5	LOCK	VCO lock detect-all 3 PLL	high for LOCK (all three PLL's)
3	PRGD	Serial Synthesizer Data Input, 16 bits word	high for logic 1. Input sequence: LO, D14, D13,...,D0. D14 is the MSB. LO: logic 1 is low transmit power.
1	NPRGEN	Serial Synthesizer Data Enable	low to enable PRGD buffer
2	PRGCLK	Serial Data Clock	held high when no clocking, clocks in data on positive edge
10	EN	Power Down all functions except Enable Buffer	high for power up, low for standby
4	NTXEN	Receive-Transmit Switch	high for receive, low for transmit

The time constant of the data slicer is set through the pins FSH and FN for the STB4395A and through FSH only for the STB4395(FN internally connected to High), as listed in the following table :

PIN		FN	
		High	Low
FSH	High	Slow, DO active	Fast, DO active
	TriState	Fast, DO active	Fast, DO active
	Low	Hold, DO high	Fast, DO high

1.5 - Power Supply Pins

Pin	Symbol	Description
64	VND	Negative supply for digital regulators, digital input and output buffers
48	VNIF	Negative supply for IF regulators, data output buffer
11	VNOSC	Negative supply for the oscillator regulators + substrate
49	VNRF	Negative supply RF regulators, quadrature input buffers
53	VNPA	Negative supply for PA
62	VPD	Positive supply for digital circuitry
32	VPI	Positive supply for receive oscillator + charge pump
45	VPIF	Positive supply for RX IF + baseband sections
17	VPO	Positive supply for transmit oscillator + charge pump
54, 57	VPRF1 / VPRF2	Positive supplies for RF front end
23, 26	VPS1/ VPS2	Positive supplies for ch. select oscillator + charge pump
63	VRD	Regulated negative supply for digital circuitry
36	VRI	Regulated negative supply for receive oscillator + charge pump
38	VRIF	Regulated negative supply for RX IF + baseband sections
13	VRO	Regulated negative supply for transmit oscillator + charge pump
52	VRRF	Regulated negative supply for RF front end
22	VRS	Regulated negative supply ch. select oscillator + charge pump

2 - BLOCK DIAGRAM

Figure 1

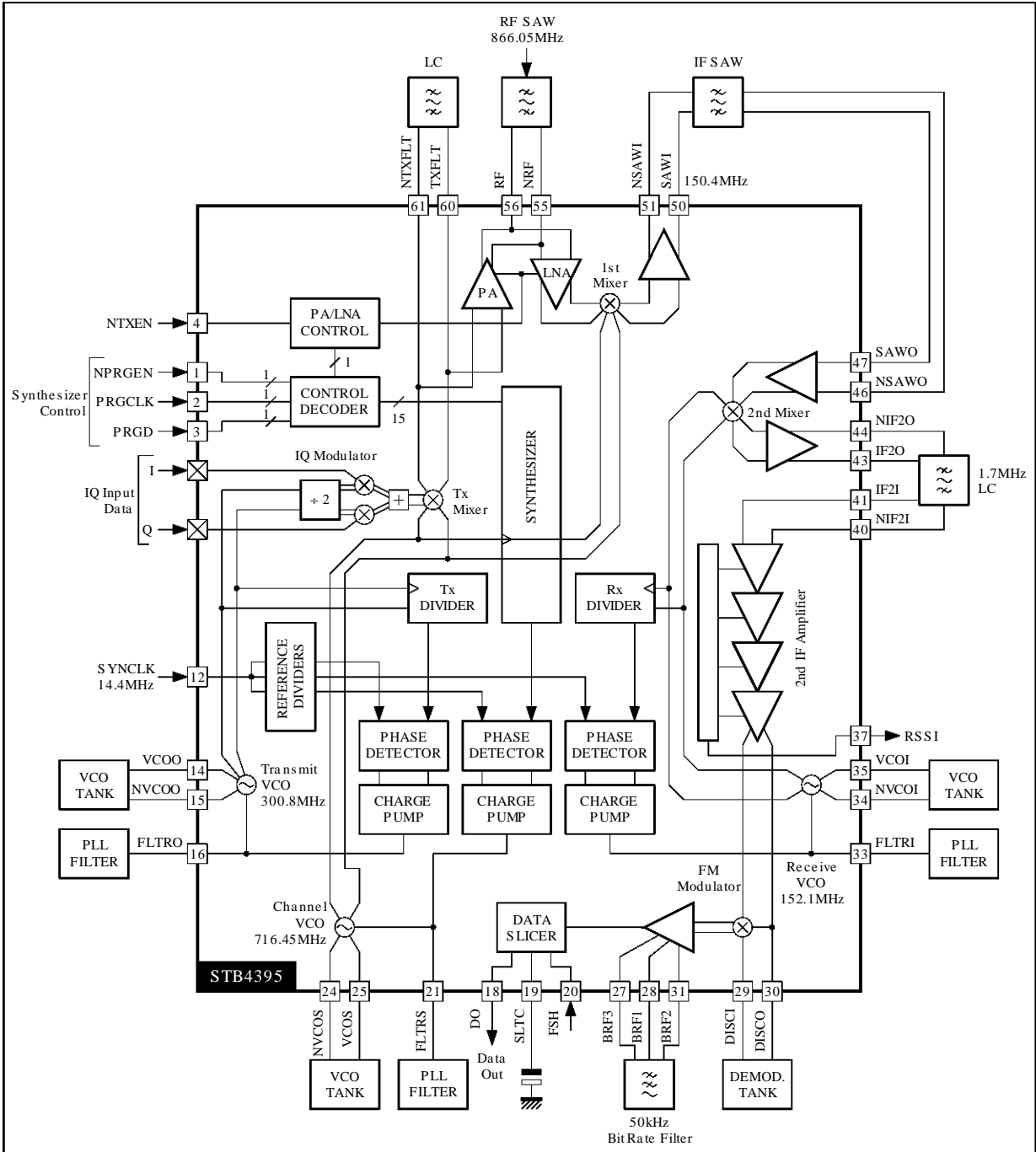

4395-03.EPS

3 - FUNCTIONAL DESCRIPTION

Figure 1 is a simplified block diagram of the circuit. It shows the key on-chip and off-chip functional blocks and signal paths. For illustration purposes frequencies have been added representing the situation when receiving or transmitting a particular CT2 channel.

3.1 - Receiver

The receive signal enters the STB4395 via an input SAW filter (866 MHz for CT2 in Europe). The RF filter changes the input signal from a single ended to a balanced signal, after which the signal passes through the LNA, first mixer, and mixer buffer. The mixer is driven by the channel VCO, which is in turn controlled by the synthesizer.

The signal path continues via the first IF SAW (150.4MHz), IF amplifier to the second mixer. The second mixer stage mixes down to 1.7MHz, and via an external LC IF filter, is passed to the second IF amplifier, where the main system gain takes place. The RSSI output is available from this point. The signal is then demodulated and sliced into a data stream which is the binary digital output available to the base band chip.

The channel selection is provided by the two external filters: the first IF SAW and a second IF 2-pole LC filter.

3.2 - Transmitter

The chip accepts 72Kbits/s data in an I/Q format. The I/Q inputs pass via the I/Q modulator to the TX mixer. The TX mixer is driven by the same channel VCO as the receive first mixer.

The on-off ramp of the transmit PA is controlled via an external capacitor to give minimum spurious responses when switching on and off.

The PA output power can be switched from full power to -3dBm by the channel select control signal (bit LO of the 16bits serial word PRGD, see table, paragraph 1.4).

3.3 - Channel Select Control Logic

All channel phase locked loops and oscillators are included on chip. The channel control synthesizer is controlled externally via a 3 wire interface.

The Reference clock input of 14.4 MHz is divided using preset counters to set the phase detector /charge pump loops for the synthesizer/channel select VCO, the second receiver VCO, and the I/Q transmit VCO. The phase detector inputs for the fixed frequency VCO's are via pre set dividers also.

The channel select control and Transmit PA control is via a 16 bit serial word, which is generated by the system controller. 15 bits of this serial word are used for the channel information, and 1 bit is used to set the output power of the transmit PA. The word length is sufficient to give full channel coverage over the range from 800 to 1000MHz with integer multiples of 50KHz. The section "system clock input" gives a detailed description.

Not shown in the diagram are the voltage regulators for the receive LNA/first mixer, Transmit PA, TX mixer and the remainder of the circuit. There are 6 internal voltage regulators to ensure the minimum of mutual interference.

4 - ABSOLUTE MAXIMUM RATINGS

Symbol	Parameter	Value	Unit
$V_P - V_N$	Power Supply Voltage	7.0	V
$V_P - V_{IN}$	Voltages on Input (except SYNCLK)	5.9	V
$V_P - V_{IN}$	Voltage on Input (SYNCLK)	3.0	V
$V_{IN} - V_N$	Voltages on Input	7.0	V
$V_P - V_{OUT}$	Voltages on Output	7.0	V
$V_N - V_{OUT}$	Voltages on Output	7.0	V
V_{RFO}	Voltage Out of RF or NRF in TX	3.5	V_{PP}
T_{stg}	Storage Temperature	125	°C
T_{oper}	Operating Temperature	40	°C

5 - POWER SUPPLIES

5.1 - Supplies

The chip operates from a power supply of 3.0 to 5.5 Volts. All interface circuits to the baseband chips are operated between these supplies.

Six on-chip regulators are included on-chip which provide to all parts of the circuit separate regulated voltage supplies of -2.85 ± 0.15 Volts relative to the top rail for the RF circuitry, the IF circuitry, the digital circuitry and for the three VCO's.

The chip can be operated in 3 modes, power down, receive and transmit. Power down is activated taking the Pin EN to V_N . To transfer to the receive mode, NTXEN is taken to V_P .

The built-in regulators can be by-passed ,if so required.

5.2 - Ground Plane Connections

The chip has been designed to be decoupled to the

positive supply, V_P , at many points. Therefore it is strongly recommended that the chip be mounted on a board with a ground plane connected to V_P .

Because the base band chip is specified relative to a negative ground, it is further recommended that the board used is a 4 layer board with both a positive, V_P , and negative ground plane V_N . This has the additional advantage of providing good high frequency decoupling between supplies.

The question as to whether to call V_P or V_N ground depends on which external equipment is connected. For testing the baseband section, this is V_N ; for testing the radio chip, this is V_P . In a product, this will depend on the application.

For clarity all voltages specified in this document will be specified with respect to the supply, V_P or V_N , that the voltage normally tracks with when the supply is varied.

6 - ELECTRICAL CHARACTERISTICS

Symbol	Parameter	Min.	Typ.	Max.	Unit
V_N	Power Supply Voltage (unregulated)	-3		-5.5	V
V_{REG}	Power Supply bypassing Internal Regulators (this is also interface supply)	-2.7		-3	V
IRX	Receive Mode		32	40	mA
ITX	Transmit Mode		68	80	mA
IQ	Standby/Power Down			20	μ A

7 - TIMING INFORMATION

7.1 - Turn on-off Times

Times are relative to the NTXEN transition (high to low for receive to transmit and low to high for transmit to receive).

Symbol	Parameter	Min.	Typ.	Max.	Unit
t_{ON}	Turn-on Time From standby to receive			10	μ s
t_{RAMPON}	PA Power Ramp up to reach -3dB of final power			27.78	μ s
t_{TXRX}	Switchover Time Transmit to Receive (LNA/first mixer active)			27.78	μ s

7.2 - Channel Select Timing

PRGCLK must be high before NPRGEN goes low to programme the synthesizer.

Figure 2 : Timing of Serial Programming Data

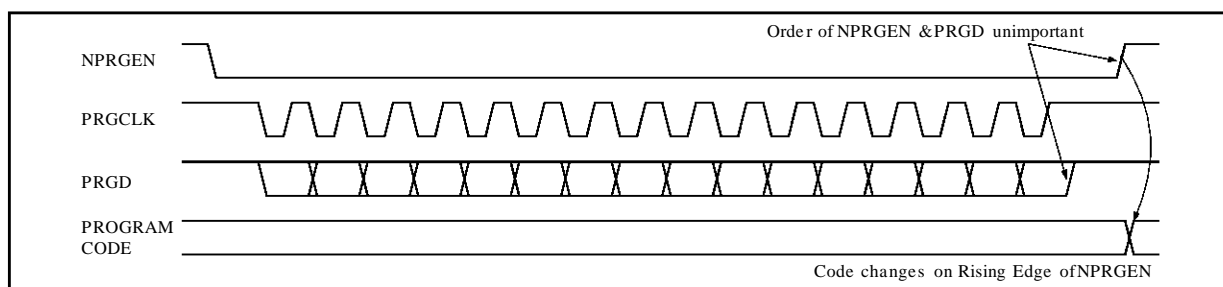

Note that although a new program code is implemented on the rising edge of the NPRGEN, the transmitted power level is delayed until at the start of the next burst of transmission. In order to change transmit power during a conversation, the required power code must be serially loaded with the power change instruction.

8 - TRANSCEIVER SECTION

Symbol	Description	Min.	Typ.	Max.	Unit
f _{OP}	Frequency Range	800		1000	MHz
	Channel Frequency Accuracy	-1	0	1	kHz
	Modulation Deviation (synchronised with 72 Kbits/s data rate)		18		kHz
P _{OUTTX}	Output Power (300Ω balanced) high power mode	13			dBm
	Sensitivity (source 300Ω balanced) for 1E-3 BER	-103	-105		dBm
	Signal max. for 1E-3 BER			0	dBm

8.1 - Receiver-Input Specification

LNA, first mixer and buffer

Symbol	Parameter	Min.	Typ.	Max.	Unit
	Conversion voltage gain		33.7 ± 1.5		dB
	Available conversion power gain		21.5 ± 1.5		dB
	Input impedance		300Ω // 3pF		-
	Output impedance		5kΩ // 3pF		-
	Source impedance		300Ω // -3pF		-
	Load impedance		5kΩ // -3pF		-
	Noise figure		3.5		dB
	1dB compression point (input)		-24		dBm
	Third order intercept (input)		-14		dBm

First IF amplifier, second mixer and buffer

Symbol	Parameter	Min.	Typ.	Max.	Units
	Conversion Voltage Gain		22.0 ± 1.5		dB
	Available Conversion Power Gain		16.3 ± 1.5		dB
	Input Impedance		700Ω // 2pF		-
	Output Impedance		2kΩ // 2pF		-
	Source Impedance		700Ω // -2pF		-
	Load Impedance		2.8kΩ // -2pF		-
	Noise Figure		6		dB
	1dB Compression Point (input)		-32		dBm
	Third Order Intercept (input)		-22		dBm

Second IF amplifier

Symbol	Parameter	Min.	Typ.	Max.	Unit
	Conversion Voltage Gain		82 ± 3		dB
	Available Power Gain (to DISCO)		86 ± 3		dB
	Bandwidth (3dB)		3		MHz
	Input Impedance		10kΩ // pF		-
	Output Impedance (to DISCO)		1.1kΩ // 2F		-
	Source Impedance		2.2kΩ // -2pF		-
	Load Impedance (at DISCO)		see App. Diag.		
	Noise Figure		6		dB
	1dB Compression Point (input)		-108		dBm

8 - TRANSCEIVER SECTION (continued)**Dataslicer time constants**

Symbol	Parameter	Min.	Typ.	Max.	Unit
	Slow		3*		ms
	Fast		130*		μs
	Hold Drift Rate 60mV < signal < 100mV		1		mV/ms

For 33nF capacitor at SLTC

8.2 - Transmitter-Output Specification

Symbol	Parameter	Min.	Typ.	Max.	Unit
P _{OUT}	Output Power into 300Ω balanced, high power mode	13			dBm
	LO Rejection	25			dBc
	Output Control Switch		14		dB

TXFLT/NTXFLT output

Symbol	Parameter	Min.	Typ.	Max.	Units
	Output Impedance		2		kΩ
	Load Impedance (external)		1.2		kΩ
	Voltage Out (channel frequency, application circuit of this D/S)		200		mV _{PP}
	Voltage Out (channel frequency-300.8MHz, app. cct of this D/S)		80		mV _{PP}

8.3 - Synthesizer/Modulator/Channel Select Loop**8.3.1 - Synthesizer Phase Noise and Spurious**

Phase noise and spurious are measured at the RF outputs RF / NRF in transmit mode, no RF SAW filter.

Phase Noise (Average)

Offset Frequency from carrier	Min.	Typ.	Max.	Unit
±100kHz		-106		dBc/Hz
±500kHz		-121		dBc/Hz
±1MHz		-127		dBc/Hz
±10MHz		-145		dBc/Hz

Spurious

Offset Frequency from carrier	Min.	Typ.	Max.	Unit
±50kHz		-55		dBc
±100kHz		-63		dBc
±200kHz		-70		dBc
±200kHz to ±10MHz		-75		dBc
±10MHz to ±100MHz		-40		dBc

8.3.2 - Channel Select Loop

Symbol	Parameter	Min.	Typ.	Max.	Unit
	Frequency		channel - 150.4		MHz
	Frequency Steps		50		kHz

8 - TRANSCEIVER SECTION (continued)**8.3.3 - Channel Frequency Setting****8.3.3.1 - General Case**

Using, from the divider ratios : and from the mixers :

$$F_{CH} = CH * F_X / 288$$

$$F_{IF2} = F_{RX} - F_{IF1}$$

$$F_{RX} = RX * F_X / 16$$

$$F_{IF1} = F_{RF} - F_{CH}$$

$$F_{IFTX} = 0.5 * F_{TX}$$

$$F_{RF} = F_{CH} + F_{IFTX}$$

$$F_{TX} = TX * F_{SYN} / 18$$

the RF frequency is related to the other frequencies by :

$$F_{RF} = F_{CH} + F_{IFTX} = CH * F_{SYN} / 288 + TX * F_{SYN} / 18 * 0.5$$

$$= F_{CH} + F_{RX} - F_{IF2} = CH * F_{SYN} / 288 + RX * F_{SYN} / 16 - F_{IF2}$$

Hence the channel select input (15 of the 16 digits, see pin table, paragraph 1.4) serial data stream :

$$CH = (F_{RF} - TX * F_{SYN} / 18 * 0.5) * 288 / F_{SYN} = 288 * F_{RF} / F_{SYN} - 3008 \text{ and } CH = 288 (F_{RF} + F_{IF2}) / F_{SYN} - 3042$$

where :

F_{CH} is the channel PLL synthesizer frequency

F_{IF1} is the first if frequency (receive)

F_{IF2} is the second if frequency (receive)

F_{IFTX} is the transmit if frequency

F_{RF} is the desired rf frequency

F_{RX} is the receive offset PLL frequency

F_{SYN} is the reference input frequency (on SYNCLK)

F_{TX} is the transmit offset PLL frequency

RX is the fixed receive divide ratio of 169

TX is the fixed transmit divide ratio of 376

CH is the channel synthesizer divide ratio defined by the binary channel number,

e.g. D14, D13, D0

The channel synthesizer provides integral division for all numbers between 3968 and 32764 (binary 000111110000000 to 11111111111100). Binary numbers outside this range will cause division ratios not directly related to binary code.

8.3.3.2 - Particular Case. with $F_{SYN} = 14.4\text{MHz}$:

$$F_{RX} = 152.1\text{MHz}$$

$$F_{TX} = 300.8\text{MHz}$$

$$F_{IFTX} = 150.4\text{MHz}$$

$$F_{IF1} = 150.4\text{MHz}$$

$$F_{IF2} = 1.7\text{MHz}$$

$$\text{Then } CH = 20 * F_{RF} - 3008$$

Example : desired RF frequency, $F_{RF} = 866.05\text{MHz}$

Then substituting in : $CH = 20 * 866.05 - 3008 = 14313$ (binary 01101111101001)

8 - TRANSCEIVER SECTION (continued)

8.4 - System Clock Input

Symbol	Description	Min.	Typ.	Max.	Unit
f_{REF} (*1)	Reference Frequency		14.4		MHz
V_S	Input Voltage Swing, AC Coupled, referenced to V_P	0.4		0.8	V
I_{IH}	Input Current-High (with respect to V_N)	-40			μA
I_{IL}	Input Current-low (with respect to V_N)			40	μA

(*1) limits according to ETSI specification

8.5 - RF/NRF Receive/Transmit Pins

Symbol	Description	Min.	Typ.	Max.	Unit
Z_{IN}	Input Impedance (balanced, RX)		300 Ω // 3.5pF		-
VSWR	VSWR			1.5:1	-
$V_{IN DC Max.}$	DC Input Voltage			0	V
$P_{IN AC Max.}$	AC Input Power			0	dBm
Z_{OUT}	Output Impedance (balanced, TX)		300 Ω // 3pF		-

8.6 - Digital Input Buffers NTXEN, PRGD, NPRGEN, PRGCLK, FN

Symbol	Description	Min.	Typ.	Max.	Unit
V_{IH}	Upper Level Input Voltage	$V_P - 1$		$V_P + 0.4$	V
V_{IL}	Lower Level Input Voltage	$V_N - 0.4$		$V_N + 1$	V
I_{IH}	Input Current High	-10			μA
I_{IL}	Input Current Low			40	μA
T_t	Input Edge Transition	0.1		1	$\mu s/V$

8.7 - Digital Output Buffers xLOCK, DO

Symbol	Description	Min.	Typ.	Max.	Unit
V_{OH}	Upper Level Output Voltage	$V_P - 0.3$		V_P	V
V_{OL}	Lower Level Output Voltage	V_N		$V_N + 1$	V
t_R	Rise Time (load of 5pF)		0.3		$\mu s/V$
t_F	Fall Time (load of 5pF)		0.4		$\mu s/V$

8.8 - Receiver - FSH Tri State Input

Symbol	Description	Min.	Typ.	Max.	Units
V_{IH}	Upper Level Input Voltage	$V_P - 0.3$		$V_P + 0.4$	V
V_{IL}	Lower Level Input Voltage	$V_N - 0.4$		$V_N + 1$	V
I_{TR}	Tri State Current	-10		10	μA
I_{IH}	Input Current High	-100			μA
I_{IL}	Input Current Low			100	μA
T_t	Input Edge Transition	0.1		1	$\mu s/V$

8 - TRANSCEIVER SECTION (continued)

8.9 - Receiver-RSSI Output

The receiver output swings between V_P and V_N . The buffer output supplies a current to an on-chip resistor connected to V_N . The output has to be smoothed externally with a capacitor to V_N .

Symbol	Description	Min.	Typ.	Max.	Unit
P_{MIN}	Min RF Input Power Registered			-90	dBm
P_{MAX}	Max RF Input Power Registered	-44			dBm
R_{OUT}	Output Resistance (internally connected to V_N)		50		$k\Omega$
V_{MIN}	Voltage for P_{MIN}		$V_N+1.25$	V_N+2	V
V_{MAX}	Voltage for P_{MAX}	V_N	$V_N+0.25$		V
CF	conversion factor		-200		mV/decade

8.10 - Power Down Buffer, EN

Symbol	Description	Min.	Typ.	Max.	Unit
V_{IH}	Upper Level Input Voltage	$V_P - 0.3$		$V_P + 0.4$	V
V_{IL}	Lower Level Input Voltage	$V_N - 0.4$		$V_N + 0.3$	V
I_{IH}	Input Current High	-350			μA
I_{IL}	Input Current Low			10	μA
t_{ON}	Buffer Delay to LOCK HI (1)			10	ms
t_{OFF}	Buffer Delay to min Supply Current (1)			10	ms

(1) assumes application circuit with 100nF on each regulator.

8.11 - Transmitter-Data Inputs

8.11.1 - I,Q,REFIQ (STB4395A)

Symbol	Description	Min.	Typ.	Max.	Units
R_{EXT}	External Input Resistance	6.5	6.8	7	$k\Omega$
R_{INT}	Internal Input Resistance	32	40	50	$k\Omega$
R_{IM}	R_{INT} Matching Error			1	%
V_{DC}	DC Bias to R_{EXT}	$0.96V_{HS}$		$1.04V_{HS}$	V
$V_{DC\ match}$	V_{DC} Matching Error to R_{EXT}			5	mV
V_S	Peak Voltage Swing to R_{EXT}	0.45	0.5	0.56	V
$V_{S\ match}$	V_S Matching Error to R_{EXT}			0.5	dB
	Phase(I-Q)	88.5	90	91.5	degrees

$$V_{HS} = (V_P + V_N)/2$$

8.11.2 - I,Q,NI,NQ (STB4395)

$$V_{HS} = (V_P+V_N)/2 - V_{HR} = (V_P+V_{RD})/2$$

Symbol	Description	Min.	Typ.	Max.	Unit
R_{EXT}	External Input Resistance		2		$k\Omega$
R_{INT}	Internal Input Resistance	32	40	50	$k\Omega$
R_{IM}	R_{INT} Matching Error			1	%
V_{DC}	DC bias to R_{EXT}	$V_{HS}-0.7$		$V_{HR}+0.7$	V
$V_{DC\ match}$	V_{DC} Matching Error to R_{EXT}			12	mV
V_S	Peak Voltage Swing to R_{EXT}	0.7	0.75	0.85	V
$V_{S\ match}$	V_S Matching Error to R_{EXT}			20	mV
	Phase (I/Ibar and Q/Qbar)	88.5	90	91.5	degrees
	Phase I to Ibar or Q to Qbar		0		degrees

9 - APPLICATIONS

9.1 - Typical DC connection schemes

9.1.1 - Internal Regulator

The STB4395 has built-in internal regulators which allows 15mA to be used for external circuitry. The output of this regulator is -2.85V with respect to the positive supply rail.

9.1.2 - External Regulator

The STB4395 will always generate its own supply voltage(-2.85V with respect to V_P), but the I/O interfaces allow the STB4395 to swing its output levels to the supply rails (V_P to V_N). The system and baseband controller can therefore be connected from the same -unregulated- supply and be individually regulated, if required .

9.2 - Application Circuits

9.2.1 - Introduction

The STB4395 makes use of some unusual circuit

configurations :

- The STB4395 operates from positive ground. The decoupling of the supply lines should take into account that the a.c. ground connections will be reversed with respect to the baseband circuit and/or the microcontroller. The use of multilayer PCB is recommended.
- The filters have been adapted for the best performance of the IC, although standard configurations are also considered.

9.2.2 - Fully Configured Applications Example

Figure 3 is a typical application circuit for a complete system. It shows the typical external components to the circuit. As the reactance of the components is critical in many locations, the use of surface mounted components is essential. A typical component list is also attached. It also shows the typical values for the the various VCO circuits. The values are very dependent on layout.

Figure 3

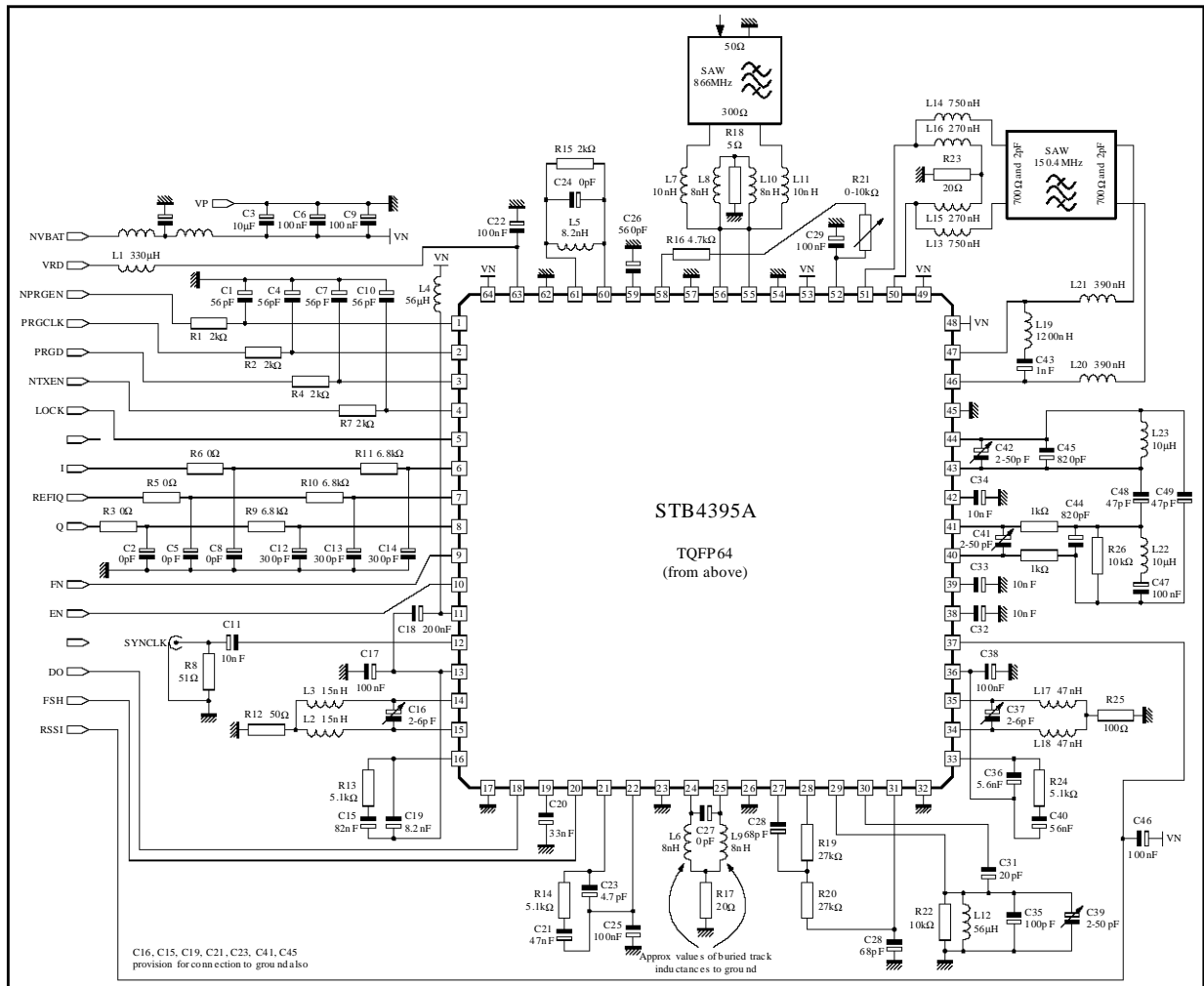

PACKAGE MECHANICAL DATA
 64 PINS - PLASTIC QUAD FLAT PACK (THIN)

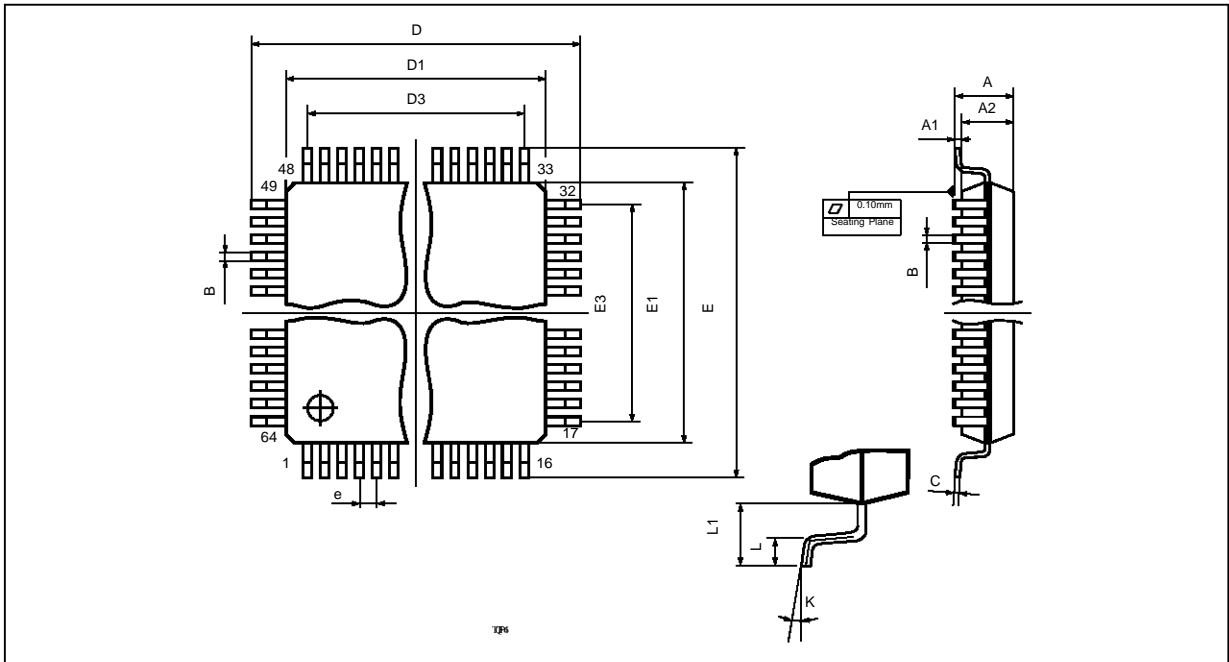

Dimensions	Millimeters			Inches		
	Min.	Typ.	Max.	Min.	Typ.	Max.
A			1.60			0.063
A1	0.05		0.15	0.002		0.006
A2	1.35	1.40	1.45	0.053	0.055	0.057
B	0.18	0.23	0.28	0.007	0.009	0.011
C	0.12	0.16	0.20	0.0047	0.0063	0.0079
D		12.00			0.472	
D1		10.00			0.394	
D3		7.50			0.295	
e		0.50			0.0197	
E		12.00			0.472	
E1		10.00	1		0.394	
E3		7.50			0.295	
K	0° (Min.), 7° (Max.)					
L	0.40	0.60	0.75	0.0157	0.0236	0.0295
L1		1.00			0.0393	

Information furnished is believed to be accurate and reliable. However, SGS-THOMSON Microelectronics assumes no responsibility for the consequences of use of such information nor for any infringement of patents or other rights of third parties which may result from its use. No licence is granted by implication or otherwise under any patent or patent rights of SGS-THOMSON Microelectronics. Specifications mentioned in this publication are subject to change without notice. This publication supersedes and replaces all information previously supplied. SGS-THOMSON Microelectronics products are not authorized for use as critical components in life support devices or systems without express written approval of SGS-THOMSON Microelectronics.

© 1996 SGS-THOMSON Microelectronics - All Rights Reserved

Purchase of I²C Components of SGS-THOMSON Microelectronics, conveys a license under the Philips I²C Patent. Rights to use these components in a I²C system, is granted provided that the system conforms to the I²C Standard Specifications as defined by Philips.

SGS-THOMSON Microelectronics GROUP OF COMPANIES

Australia - Brazil - China - France - Germany - Hong Kong - Italy - Japan - Korea - Malaysia - Malta - Morocco
 The Netherlands - Singapore - Spain - Sweden - Switzerland - Taiwan - Thailand - United Kingdom - U.S.A.