

Features

- Low saturation switching application
- Voltage regulator application
- Low saturation : $V_{CE(SAT)}=0.4V$ Max.
- High Voltage : $V_{CEO}=60V$ Min.

Ordering Information

Type NO.	Marking	Package Code
STC401	STC401	TO-92

Outline Dimensions

unit : mm

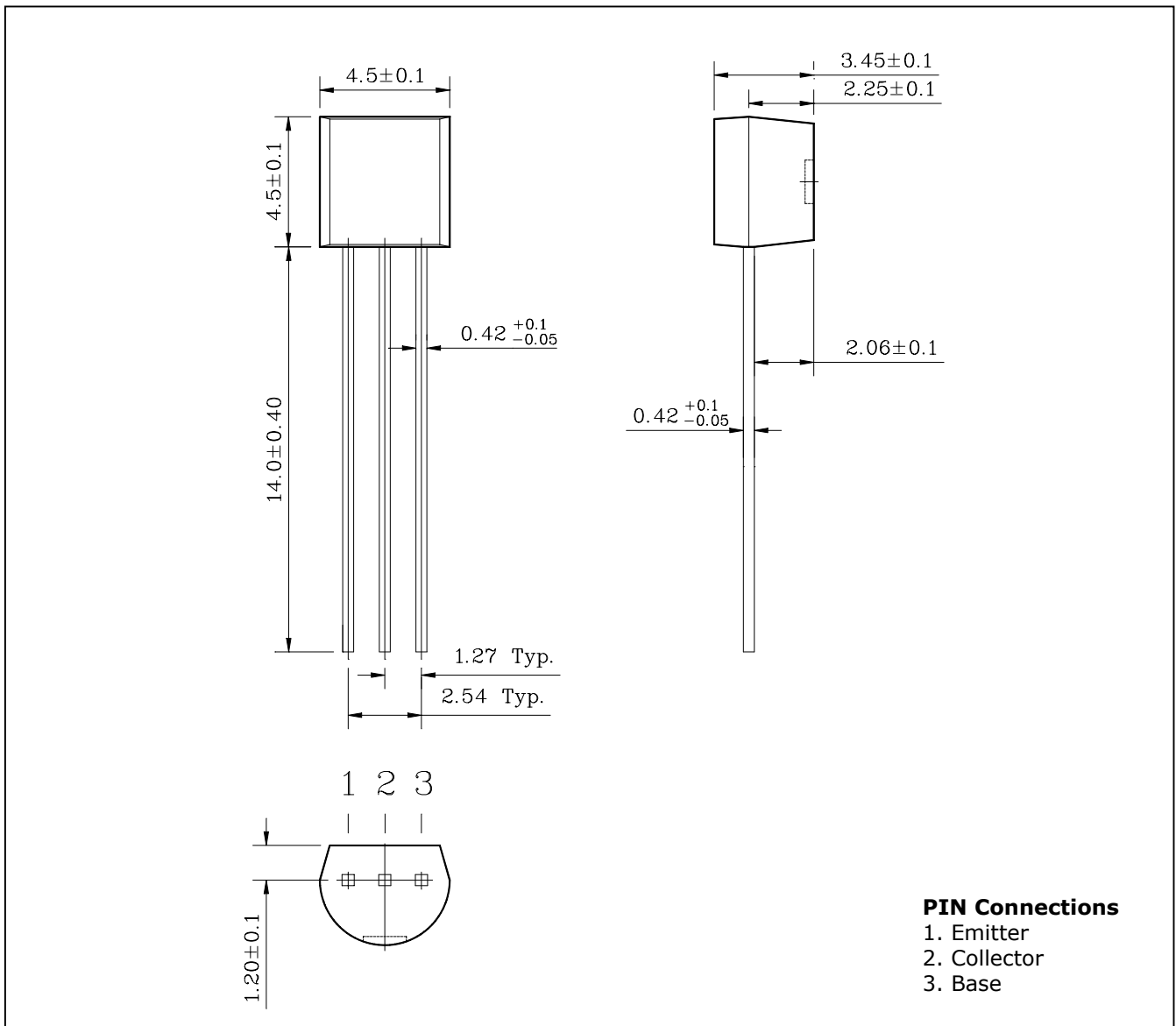

Absolute maximum ratings

Characteristic	Symbol	Ratings	Unit
Collector-Base voltage	V_{CBO}	80	V
Collector-Emitter voltage	V_{CEO}	60	V
Emitter-base voltage	V_{EBO}	5	V
Collector current	I_C	1	A
Collector dissipation	P_C	625	mW
Junction temperature	T_j	150	°C
Storage temperature	T_{stg}	-55~150	°C

Electrical Characteristics

Characteristic	Symbol	Test Condition	Min.	Typ.	Max.	Unit
Collector-Emitter breakdown voltage	BV_{CEO}	$I_C=1mA, I_B=0$	60	-	-	V
Collector cut-off current	I_{CBO}	$V_{CB}=60V, I_E=0$	-	-	0.1	μA
Emitter cut-off current	I_{EBO}	$V_{EB}=5V, I_C=0$	-	-	0.1	μA
DC current gain	h_{FE}^*	$V_{CE}=2V, I_C=100mA$	200	-	400	-
		$V_{CE}=2V, I_C=1A$	80	-	-	
Base-Emitter on voltage	$V_{BE(ON)}$	$V_{CE}=2V, I_C=500mA$	-	-	1.2	V
Collector-Emitter saturation voltage	$V_{CE(sat)}$	$I_C=500mA, I_B=50mA$	-	-	0.4	V
Collector output capacitance	C_{ob}	$V_{CB}=10V, I_E=0, f=1MHz$	-	10	-	pF
Transition frequency	f_T	$V_{CB}=10V, I_C=50mA$	-	160	-	MHz

* h_{FE} rank : 200~400 Only

Electrical Characteristic Curves

Fig. 1 $P_C - T_a$

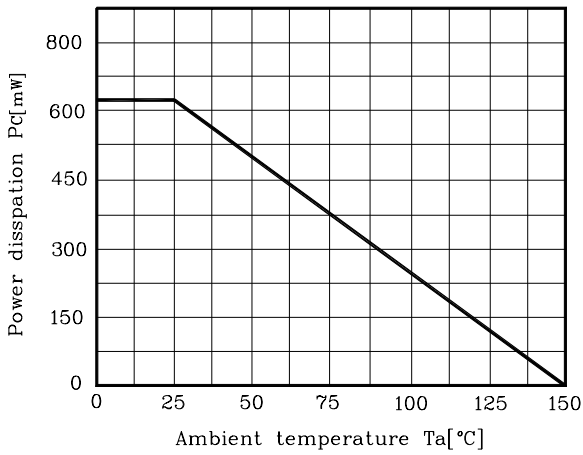

Fig. 2 $V_{CE} - I_C$

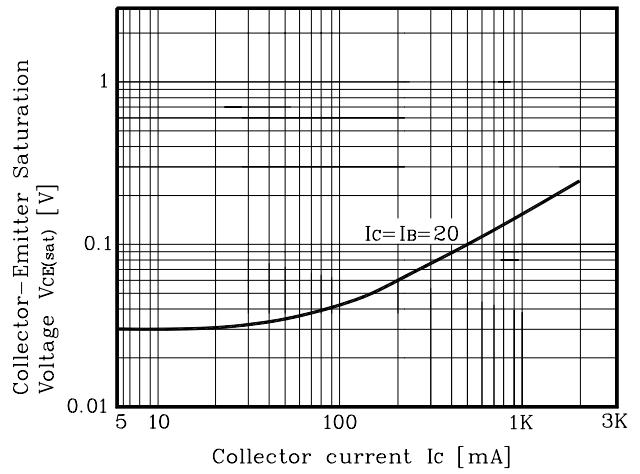

Fig. 3 $h_{FE} - I_C$

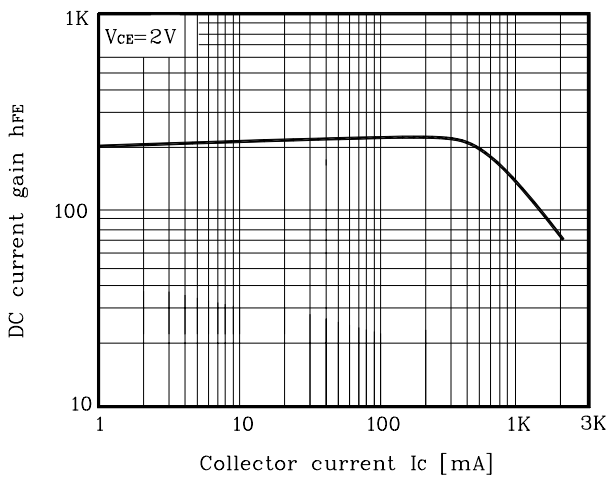

Fig. 4 $C_{ob} - V_{CB}$

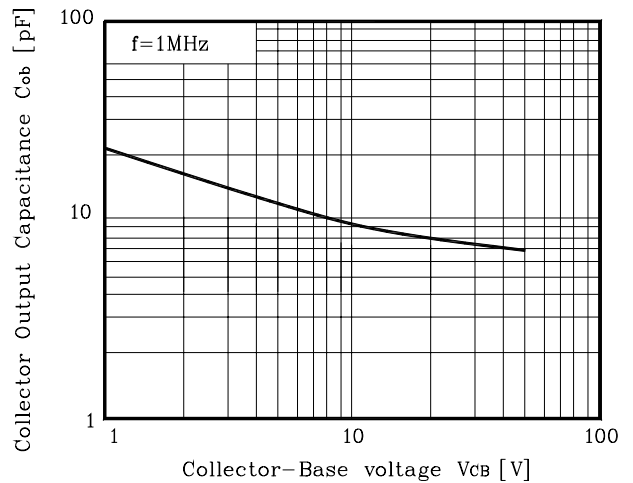

Fig. 5 $I_C - V_{CE}$

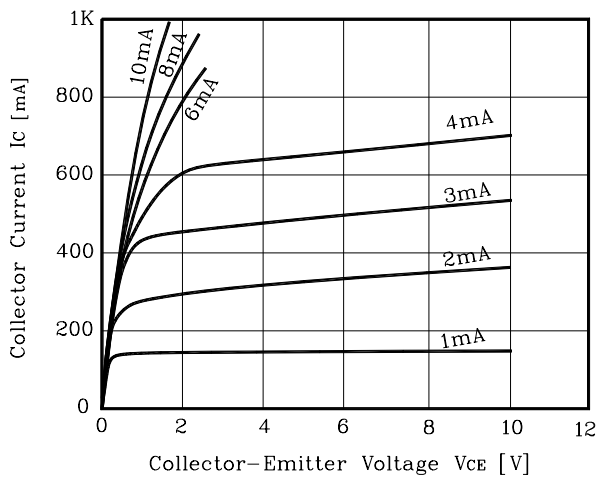
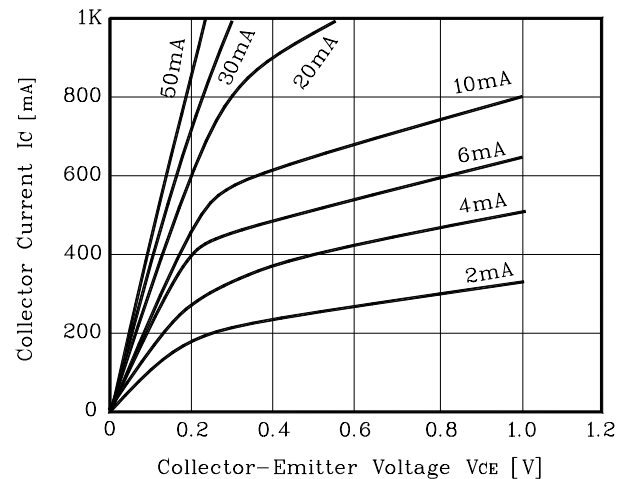

Fig. 6 $I_C - V_{CE}$



Electrical Characteristic Curves

Fig. 7 $f_T - I_C$ 