

# STD100GKxx B

## Thyristor-Diode Modules

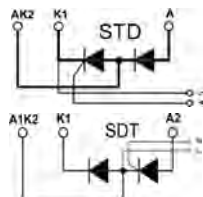

Type	$V_{RSM}$ $V_{DSM}$ V	$V_{RRM}$ $V_{DRM}$ V
STD100GK08B	900	800
STD100GK12B	1300	1200
STD100GK14B	1500	1400
STD100GK16B	1700	1600
STD100GK18B	1900	1800
STD100GK20B	2100	2000
STD100GK22B	2300	2200

Dimensions in mm (1mm=0.0394")

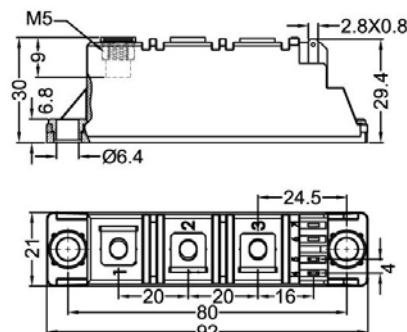

Symbol	Test Conditions	Maximum Ratings	Unit
$I_{TRMS}, I_{FRMS}$ $I_{TAVM}, I_{FAVM}$	$T_{VJ}=T_{VJM}$ $T_C=85^{\circ}C; 180^{\circ}$ sine	180 100	A
$I_{TSM}, I_{FSM}$	$T_{VJ}=45^{\circ}C$ $V_R=0$ $t=10ms$ (50Hz), sine $t=8.3ms$ (60Hz), sine	1700 1800	A
	$T_{VJ}=T_{VJM}$ $V_R=0$ $t=10ms$ (50Hz), sine $t=8.3ms$ (60Hz), sine	1540 1640	
$\int i^2 dt$	$T_{VJ}=45^{\circ}C$ $V_R=0$ $t=10ms$ (50Hz), sine $t=8.3ms$ (60Hz), sine	14450 13500	$A^2s$
	$T_{VJ}=T_{VJM}$ $V_R=0$ $t=10ms$ (50Hz), sine $t=8.3ms$ (60Hz), sine	11850 11300	
$(di/dt)_{cr}$	$T_{VJ}=T_{VJM}$ $f=50Hz, t_p=200us$ $V_D=2/3V_{DRM}$ $I_G=0.45A$ $di_G/dt=0.45A/us$	repetitive, $I_T=250A$ 150	A/us
		non repetitive, $I_T=I_{TAVM}$ 500	
$(dv/dt)_{cr}$	$T_{VJ}=T_{VJM};$ $R_{GK}=\infty;$ method 1 (linear voltage rise)	$V_{DR}=2/3V_{DRM}$ 1000	V/us
$P_{GM}$	$T_{VJ}=T_{VJM}$ $I_T=I_{TAVM}$	$t_p=30us$ 10	W
		$t_p=300us$ 5	
$P_{GAV}$		0.5	W
$V_{RGM}$		10	V
$T_{VJ}$ $T_{VJM}$ $T_{stg}$		-40...+125	$^{\circ}C$
		125	
		-40...+125	
$V_{ISOL}$	50/60Hz, RMS $I_{ISOL} \leq 1mA$	$t=1min$ 3000	V~
		$t=1s$ 3600	
$M_d$	Mounting torque (M5)	2.5-4.0/22-35	Nm/lb.in.
	Terminal connection torque (M5)	2.5-4.0/22-35	
Weight	Typical	110	g

**Sirectifier**®

# STD100GKxx B

## Thyristor-Diode Modules

Symbol	Test Conditions	Characteristic Values	Unit
$I_{RRM}, I_{DRM}$	$T_{VJ}=T_{VJM}; V_R=V_{RRM}; V_D=V_{DRM}$	15	mA
$V_T, V_F$	$I_T, I_F=300A; T_{VJ}=25^{\circ}C$	1.74	V
$V_{TO}$	For power-loss calculations only ( $T_{VJ}=T_{VJM}$ )	0.85	V
$r_T$		3.2	m $\Omega$
$V_{GT}$	$V_D=6V;$ $T_{VJ}=25^{\circ}C$ $T_{VJ}=-40^{\circ}C$	1.5 1.6	V
$I_{GT}$	$V_D=6V;$ $T_{VJ}=25^{\circ}C$ $T_{VJ}=-40^{\circ}C$	100 200	mA
$V_{GD}$	$T_{VJ}=T_{VJM};$ $V_D=2/3V_{DRM}$	0.25	V
$I_{GD}$	$T_{VJ}=T_{VJM};$ $V_D=2/3V_{DRM}$	10	mA
$I_L$	$T_{VJ}=25^{\circ}C; t_p=30\mu s; V_D=6V$ $I_G=0.45A; di_G/dt=0.45A/\mu s$	200	mA
$I_H$	$T_{VJ}=25^{\circ}C; V_D=6V; R_{GK}=\infty$	150	mA
$t_{gd}$	$T_{VJ}=25^{\circ}C; V_D=1/2V_{DRM}$ $I_G=0.45A; di_G/dt=0.45A/\mu s$	2	$\mu s$
$t_q$	$T_{VJ}=T_{VJM}; I_T=150A; t_p=200\mu s; -di/dt=10A/\mu s$ $V_R=100V; dv/dt=20V/\mu s; V_D=2/3V_{DRM}$	185	$\mu s$
$Q_S$	$T_{VJ}=T_{VJM}; I_T, I_F=50A; -di/dt=6A/\mu s$	170	$\mu C$
$I_{RM}$		45	A
$R_{thJC}$	per thyristor/diode; DC current per module	0.22 0.11	K/W
$R_{thJK}$	per thyristor/diode; DC current per module	0.42 0.21	K/W
$d_s$	Creeping distance on surface	12.7	mm
$d_A$	Creepage distance in air	9.6	mm
$a$	Maximum allowable acceleration	50	m/s <sup>2</sup>

### FEATURES

- \* International standard package
- \* Copper base plate
- \* Glass passivated chips
- \* Isolation voltage 3600 V~
- \* UL file NO.E310749
- \* RoHS compliant

### APPLICATIONS

- \* DC motor control
- \* Softstart AC motor controller
- \* Light, heat and temperature control

### ADVANTAGES

- \* Space and weight savings
- \* Simple mounting with two screws
- \* Improved temperature and power cycling
- \* Reduced protection circuits



# STD100GKxxB

## Thyristor-Diode Modules

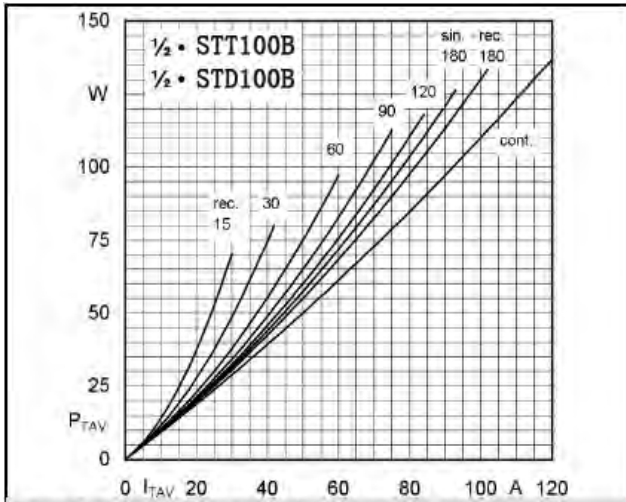

Fig. 1L Power dissipation per thyristor vs. on-state current

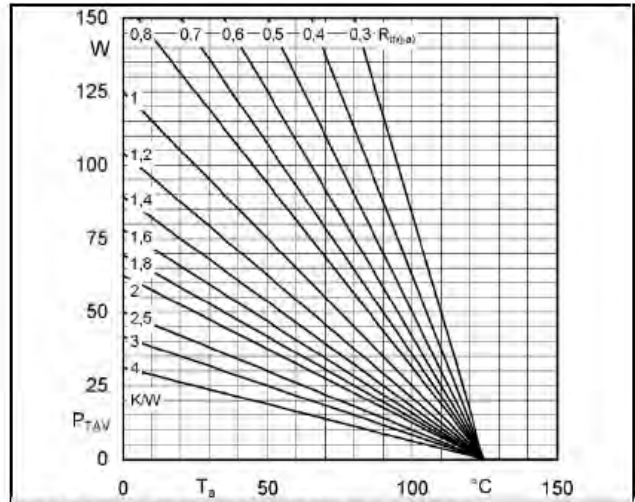

Fig. 1R Power dissipation per thyristor vs. ambient temp.

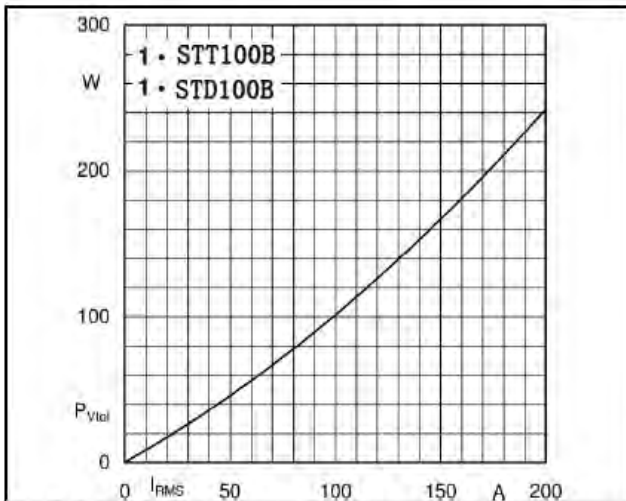

Fig. 2L Power dissipation per module vs. rms current

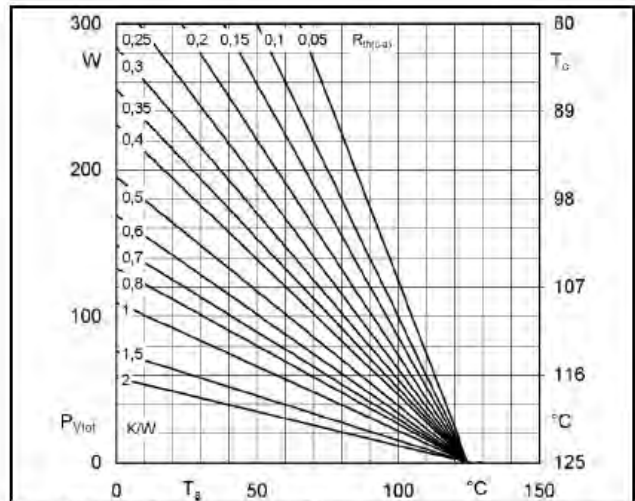

Fig. 2R Power dissipation per module vs. case temp.

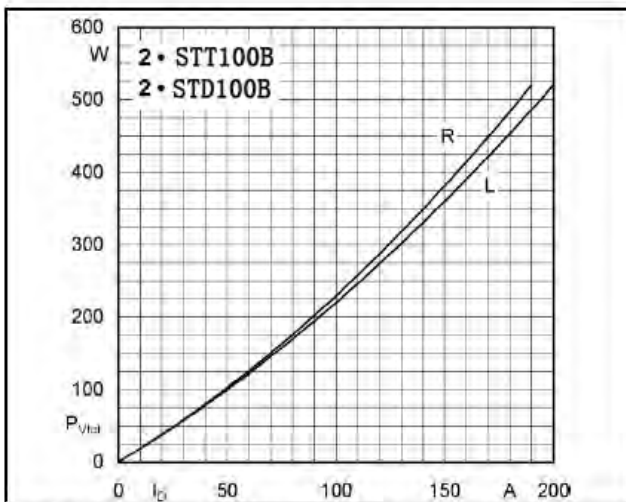

Fig. 3L Power dissipation of two modules vs. direct current

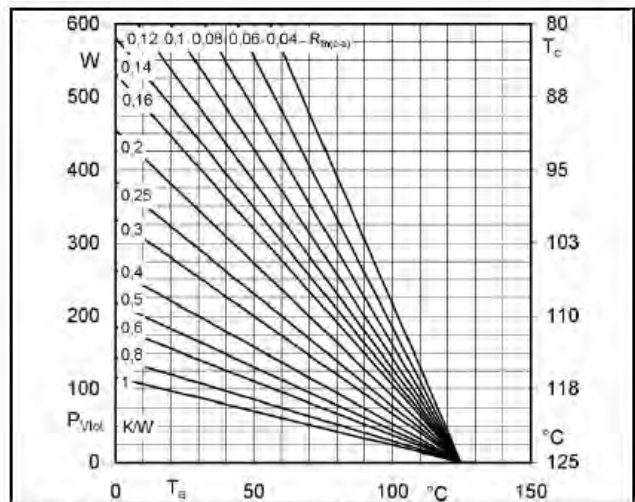

Fig. 3R Power dissipation of two modules vs. case temp.

**Sirectifier®**



# STD100GKxxB

## Thyristor-Diode Modules

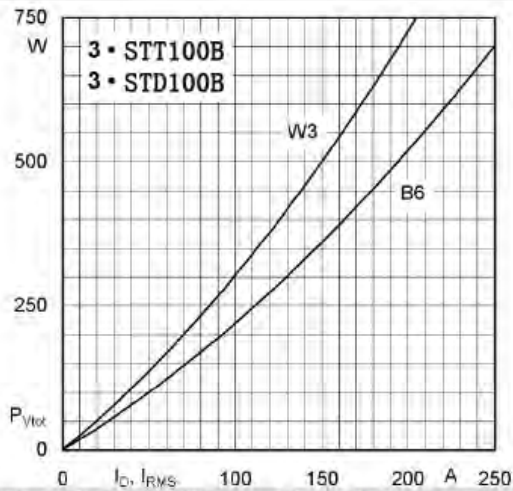

Fig. 4L Power dissipation of three modules vs. direct and rms current

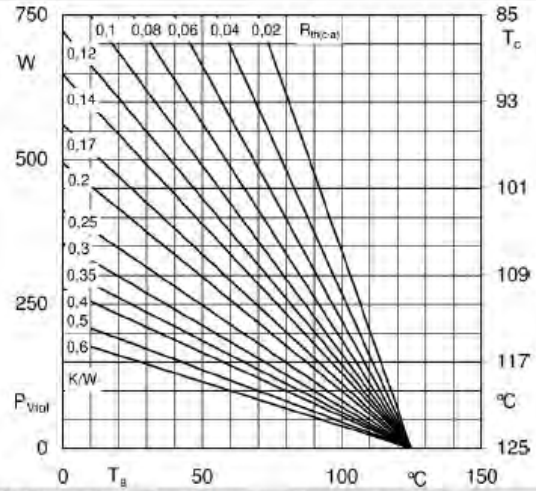

Fig. 4R Power dissipation of three modules vs. case temp.

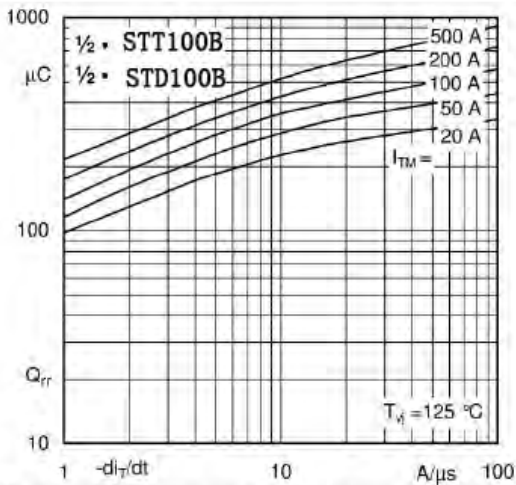

Fig. 5 Recovered charge vs. current decrease

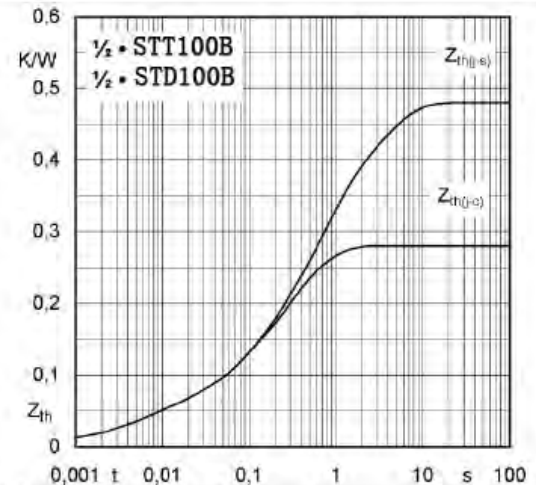

Fig. 6 Transient thermal impedance vs. time

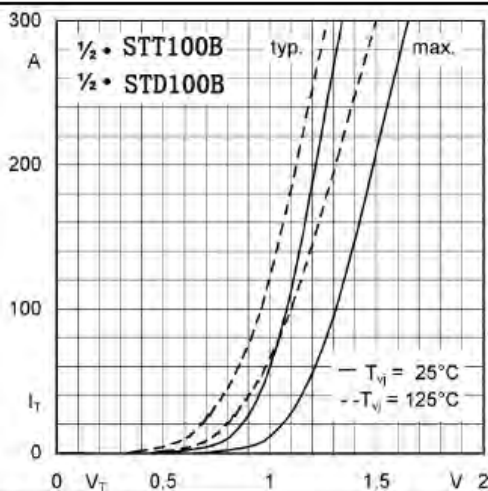

Fig. 7 On-state characteristics

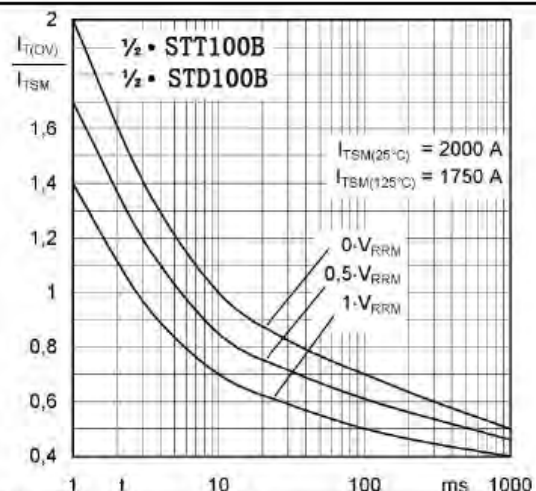

Fig. 8 Surge overload current vs. time

