

260-745

**N - CHANNEL ENHANCEMENT MODE  
POWER MOS TRANSISTOR**

TYPE	V <sub>DSS</sub>	R <sub>DS(on)</sub>	I <sub>D</sub>
STH33N20	200 V	< 0.085 Ω	33 A
STH33N20FI	200 V	< 0.085 Ω	20 A
STW33N20	200 V	< 0.085 Ω	33 A

- TYPICAL R<sub>DS(on)</sub> = 0.073 Ω
- AVALANCHE RUGGED TECHNOLOGY
- 100% AVALANCHE TESTED
- REPETITIVE AVALANCHE DATA AT 100°C
- APPLICATION ORIENTED CHARACTERIZATION

**APPLICATIONS**

- HIGH CURRENT, HIGH SPEED SWITCHING
- UNINTERRUPTIBLE POWER SUPPLY (UPS)
- MOTOR CONTROL, AUDIO AMPLIFIERS
- INDUSTRIAL ACTUATORS
- DC-DC & DC-AC CONVERTERS FOR TELECOM, INDUSTRIAL AND CONSUMER ENVIRONMENT

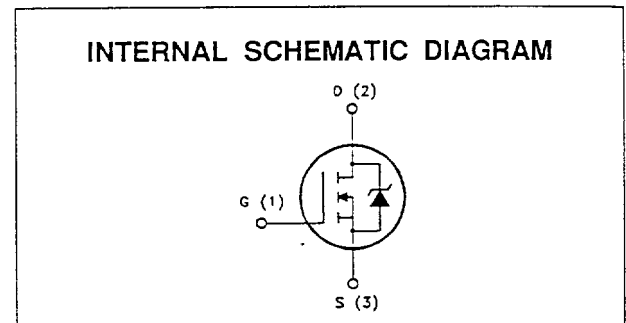
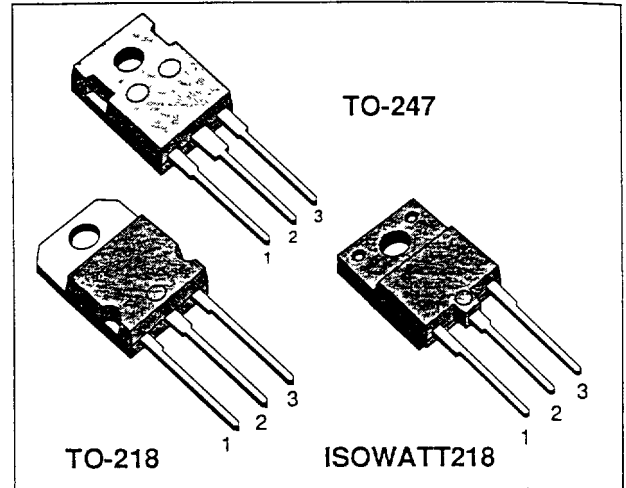

**ABSOLUTE MAXIMUM RATINGS**

Symbol	Parameter	Value		Unit
		STH/STW33N20	STH33N20FI	
V <sub>DS</sub>	Drain-source Voltage (V <sub>GS</sub> = 0)	200		V
V <sub>DGR</sub>	Drain- gate Voltage (R <sub>GS</sub> = 20 kΩ)	200		V
V <sub>GS</sub>	Gate-source Voltage	± 20		V
I <sub>D</sub>	Drain Current (continuous) at T <sub>c</sub> = 25 °C	33	20	A
I <sub>D</sub>	Drain Current (continuous) at T <sub>c</sub> = 100 °C	20	12	A
I <sub>DM</sub> (*)	Drain Current (pulsed)	132	132	A
P <sub>tot</sub>	Total Dissipation at T <sub>c</sub> = 25 °C	180	70	W
	Derating Factor	1.44	0.56	W/°C
V <sub>ISO</sub>	Insulation Withstand Voltage (DC)	—	4000	V
T <sub>stg</sub>	Storage Temperature	-65 to 150		°C
T <sub>J</sub>	Max. Operating Junction Temperature	150		°C

(\*) Pulse width limited by safe operating area

**THERMAL DATA**

			TO-218/TO-247	ISOWATT218	
R <sub>thj-case</sub>	Thermal Resistance Junction-case	Max	0.69	1.79	°C/W
R <sub>thj-amb</sub>	Thermal Resistance Junction-ambient	Max	30		°C/W
R <sub>thc-sink</sub>	Thermal Resistance Case-sink	Typ	0.1		°C/W
T <sub>l</sub>	Maximum Lead Temperature For Soldering Purpose		300		°C

**AVALANCHE CHARACTERISTICS**

Symbol	Parameter	Max Value	Unit
I <sub>AR</sub>	Avalanche Current, Repetitive or Not-Repetitive (pulse width limited by T <sub>j</sub> max, δ < 1%)	33	A
E <sub>AS</sub>	Single Pulse Avalanche Energy (starting T <sub>j</sub> = 25 °C, I <sub>D</sub> = I <sub>AR</sub> , V <sub>DD</sub> = 50 V)	150	mJ
E <sub>AR</sub>	Repetitive Avalanche Energy (pulse width limited by T <sub>j</sub> max, δ < 1%)	40	mJ
I <sub>AR</sub>	Avalanche Current, Repetitive or Not-Repetitive (T <sub>c</sub> = 100 °C, pulse width limited by T <sub>j</sub> max, δ < 1%)	20	A

**ELECTRICAL CHARACTERISTICS** (T<sub>case</sub> = 25 °C unless otherwise specified)

OFF

Symbol	Parameter	Test Conditions	Min.	Typ.	Max.	Unit
V <sub>(BR)DSS</sub>	Drain-source Breakdown Voltage	I <sub>D</sub> = 250 μA V <sub>GS</sub> = 0	200			V
I <sub>DSS</sub>	Zero Gate Voltage Drain Current (V <sub>GS</sub> = 0)	V <sub>DS</sub> = Max Rating V <sub>DS</sub> = Max Rating x 0.8 T <sub>c</sub> = 125 °C			250 1000	μA μA
I <sub>GSS</sub>	Gate-body Leakage Current (V <sub>DS</sub> = 0)	V <sub>GS</sub> = ± 20 V			± 100	nA

ON (\*)

Symbol	Parameter	Test Conditions	Min.	Typ.	Max.	Unit
V <sub>GS(th)</sub>	Gate Threshold Voltage	V <sub>DS</sub> = V <sub>GS</sub> I <sub>D</sub> = 250 μA	2	3	4	V
R <sub>DS(on)</sub>	Static Drain-source On Resistance	V <sub>GS</sub> = 10V I <sub>D</sub> = 16 A V <sub>GS</sub> = 10V I <sub>D</sub> = 16 A T <sub>c</sub> = 100°C		0.073	0.085 0.170	Ω Ω
I <sub>D(on)</sub>	On State Drain Current	V <sub>DS</sub> > I <sub>D(on)</sub> x R <sub>DS(on)max</sub> V <sub>GS</sub> = 10 V	33			A

**DYNAMIC**

Symbol	Parameter	Test Conditions	Min.	Typ.	Max.	Unit
g <sub>fs</sub> (*)	Forward Transconductance	V <sub>DS</sub> > I <sub>D(on)</sub> x R <sub>DS(on)max</sub> I <sub>D</sub> = 16 A	10	22		S
C <sub>iss</sub>	Input Capacitance	V <sub>DS</sub> = 25 V f = 1 MHz V <sub>GS</sub> = 0		2800	3600	pF
C <sub>oss</sub>	Output Capacitance			600	800	pF
C <sub>rss</sub>	Reverse Transfer Capacitance			190	250	pF

ELECTRICAL CHARACTERISTICS (continued)

SWITCHING ON

Symbol	Parameter	Test Conditions	Min.	Typ.	Max.	Unit
$t_{d(on)}$	Turn-on Time	$V_{DD} = 95\text{ V}$ $I_D = 16\text{ A}$		25	40	ns
$t_r$	Rise Time	$R_G = 4.7\ \Omega$ $V_{GS} = 10\text{ V}$ (see test circuit, figure 3)		65	95	ns
$(di/dt)_{on}$	Turn-on Current Slope	$V_{DD} = 160\text{ V}$ $I_D = 33\text{ A}$ $R_G = 50\ \Omega$ $V_{GS} = 10\text{ V}$ (see test circuit, figure 5)		200		A/ $\mu\text{s}$
$Q_g$	Total Gate Charge	$V_{DD} = 160\text{ V}$ $I_D = 33\text{ A}$ $V_{GS} = 10\text{ V}$		125	180	nC
$Q_{gs}$	Gate-Source Charge			15		nC
$Q_{gd}$	Gate-Drain Charge			62		nC

SWITCHING OFF

Symbol	Parameter	Test Conditions	Min.	Typ.	Max.	Unit
$t_{r(Voff)}$	Off-voltage Rise Time	$V_{DD} = 160\text{ V}$ $I_D = 33\text{ A}$		180	250	ns
$t_f$	Fall Time	$R_G = 50\ \Omega$ $V_{GS} = 10\text{ V}$ (see test circuit, figure 5)		105	150	ns
$t_c$	Cross-over Time			285	400	ns

SOURCE DRAIN DIODE

Symbol	Parameter	Test Conditions	Min.	Typ.	Max.	Unit
$I_{SD}$	Source-drain Current				33	A
$I_{SDM}(\bullet)$	Source-drain Current (pulsed)				132	A
$V_{SD}(\ast)$	Forward On Voltage	$I_{SD} = 33\text{ A}$ $V_{GS} = 0$			1.6	V
$t_{rr}$	Reverse Recovery Time	$I_{SD} = 33\text{ A}$ $di/dt = 100\text{ A}/\mu\text{s}$ $V_{DD} = 30\text{ V}$ $T_J = 150\text{ }^\circ\text{C}$ (see test circuit, figure 5)		450		ns
$Q_{rr}$	Reverse Recovery Charge			5		$\mu\text{C}$
$I_{RRM}$	Reverse Recovery Current			22		A

( $\ast$ ) Pulsed Pulse duration = 300  $\mu\text{s}$ , duty cycle 1.5 %  
 ( $\bullet$ ) Pulse width limited by safe operating area

Safe Operating Areas For TO-218 and TO-247

Safe Operating Areas For ISOWATT218

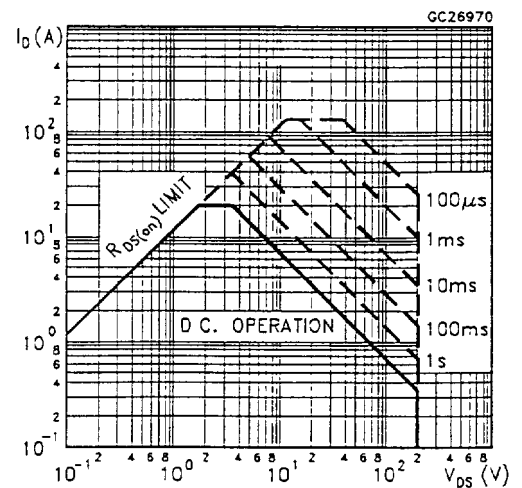
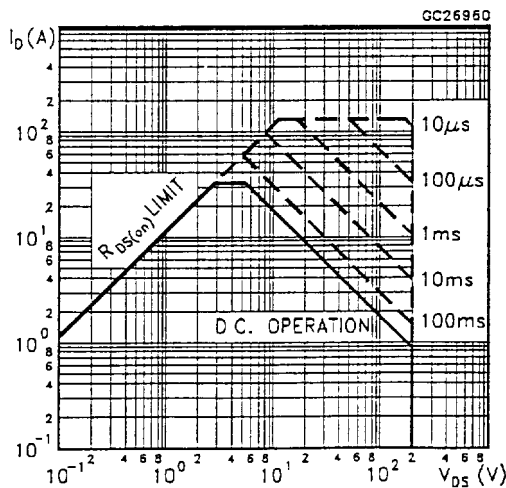

Thermal Impedance For TO-218 and TO-247

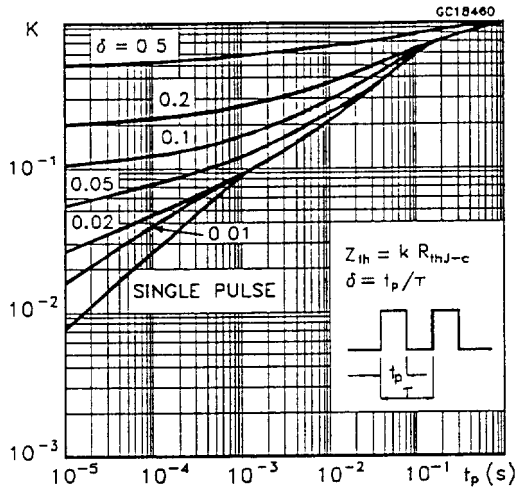

Thermal Impedance For ISOWATT218

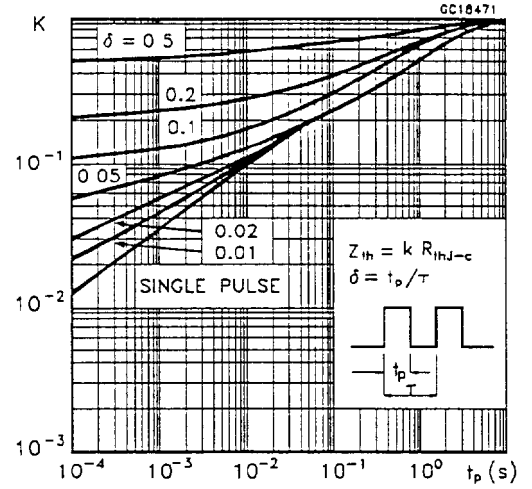

Derating Curve For TO-218 and TO-247

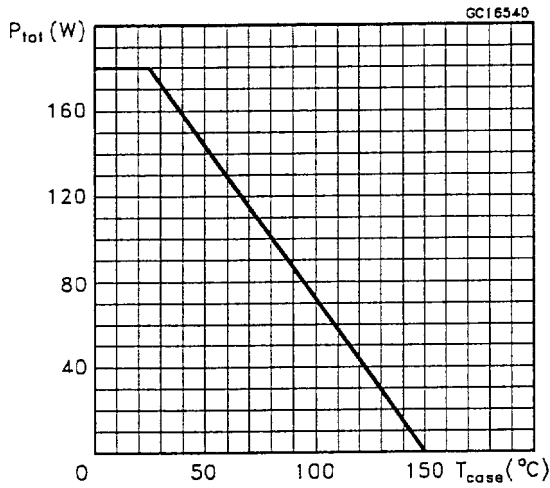

Derating Curve For ISOWATT218

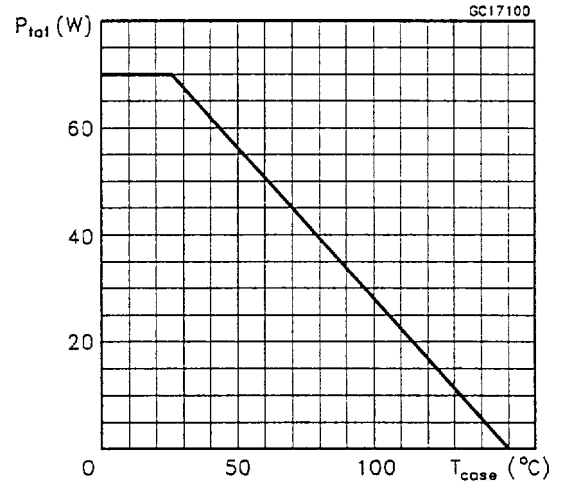

Output Characteristics

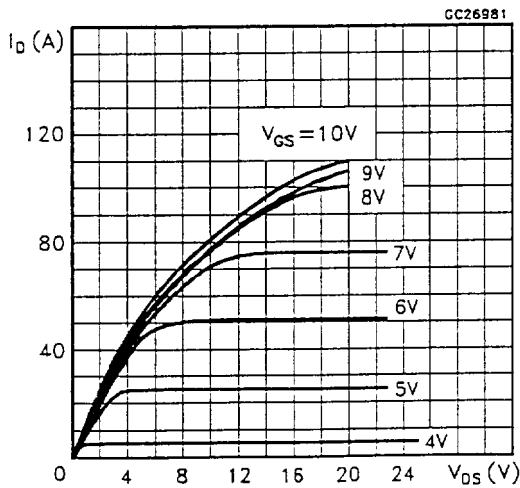

Transfer Characteristics

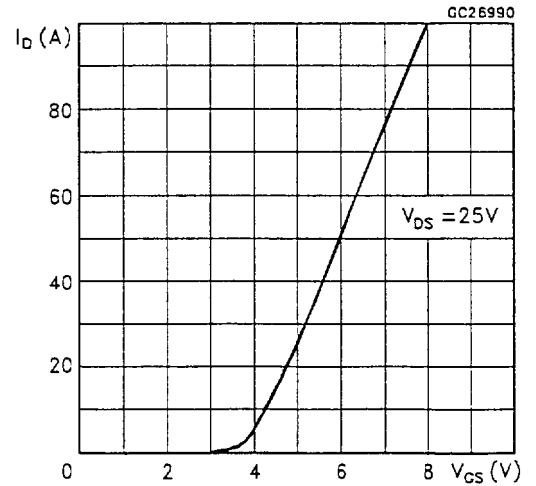

Transconductance

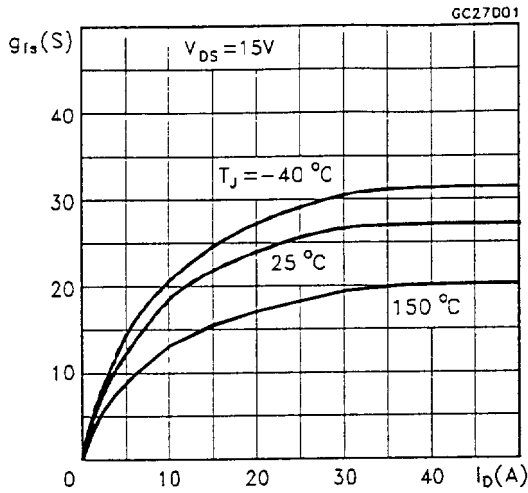

Static Drain-source On Resistance

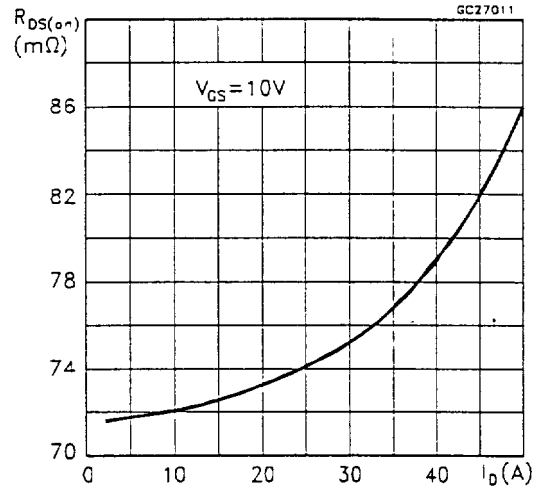

Gate Charge vs Gate-source Voltage

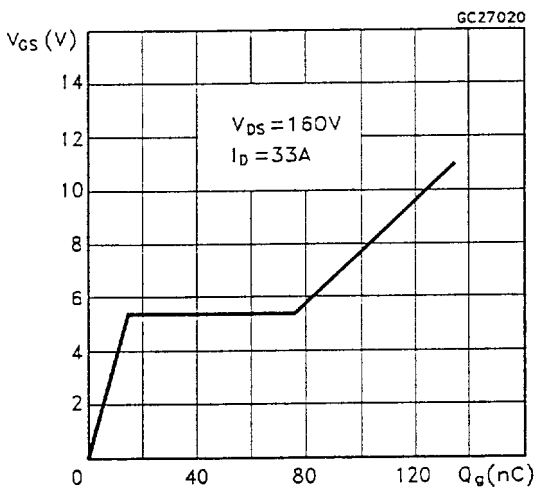

Capacitance Variations

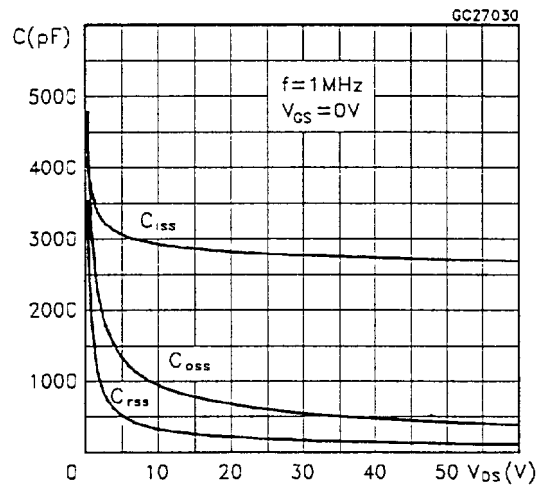

Normalized Gate Threshold Voltage vs Temperature

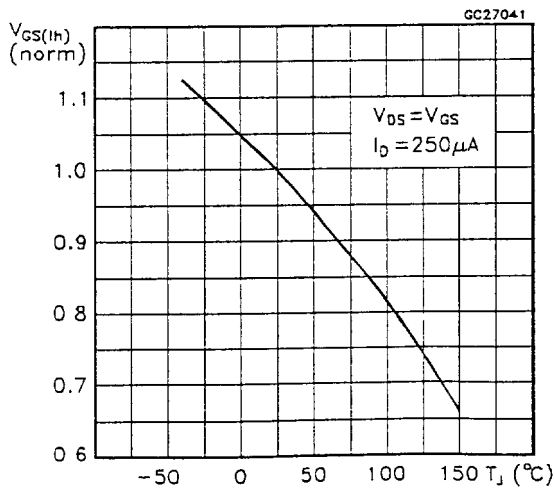

Normalized On Resistance vs Temperature

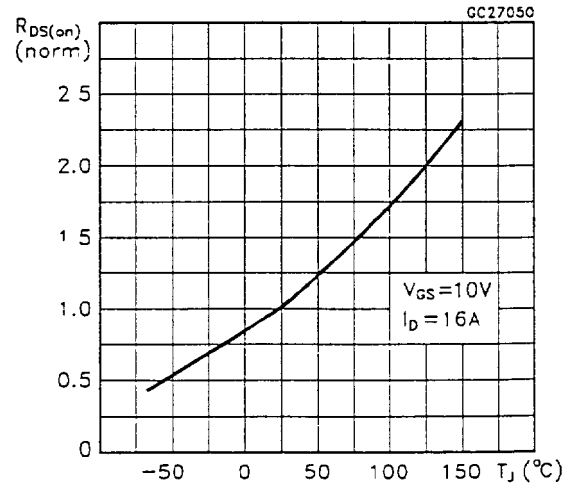

Turn-on Current Slope

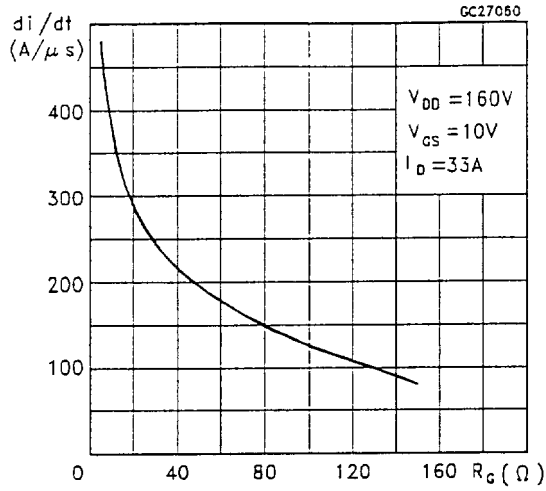

Turn-off Drain-source Voltage Slope

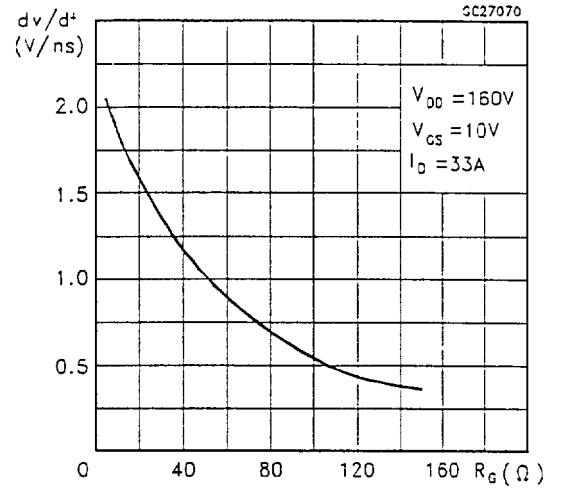

Cross-over Time

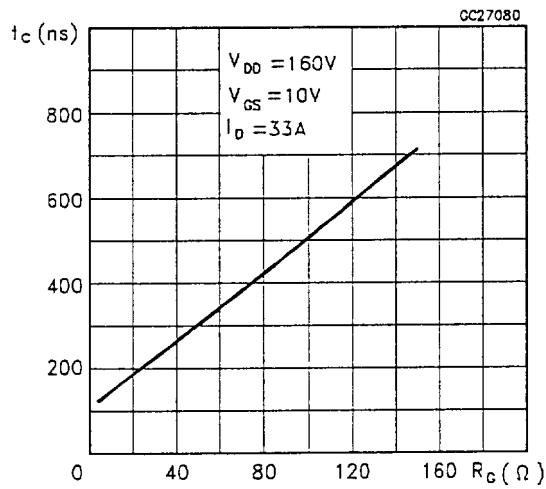

Switching Safe Operating Area

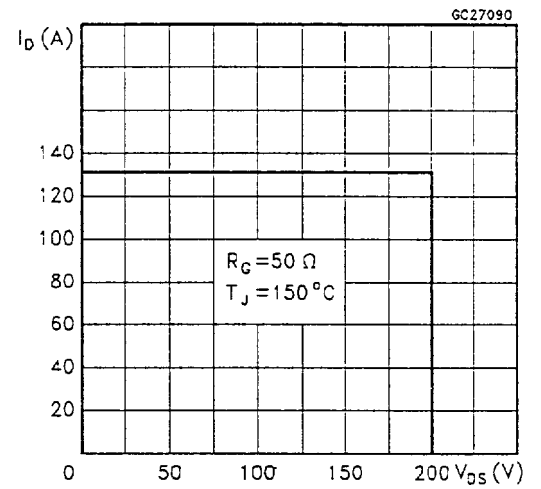

Accidental Overload Area

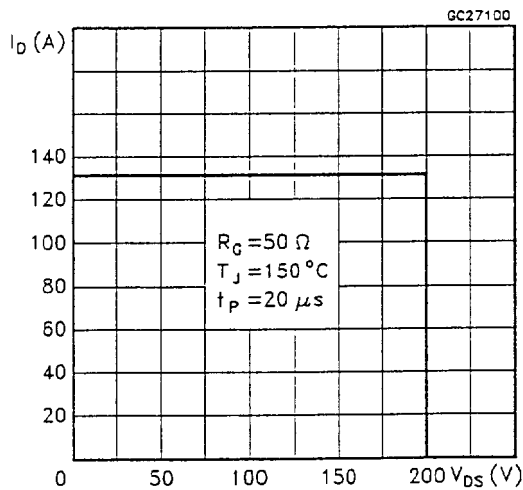

Source-drain Diode Forward Characteristics

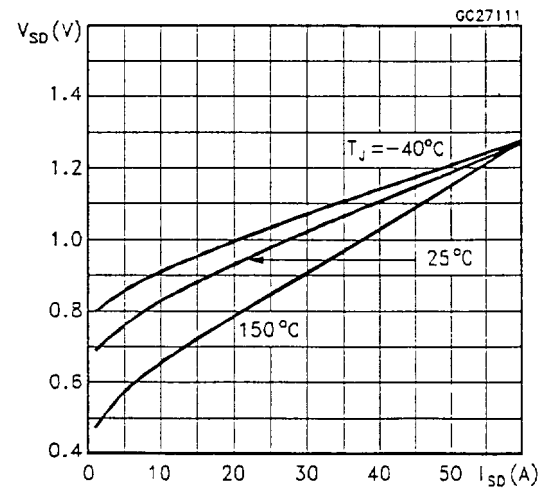

Fig. 1: Unclamped Inductive Load Test Circuits

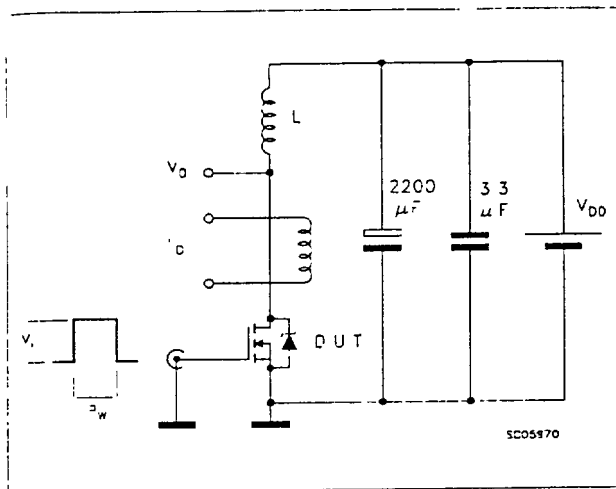

Fig. 2: Unclamped Inductive Waveforms

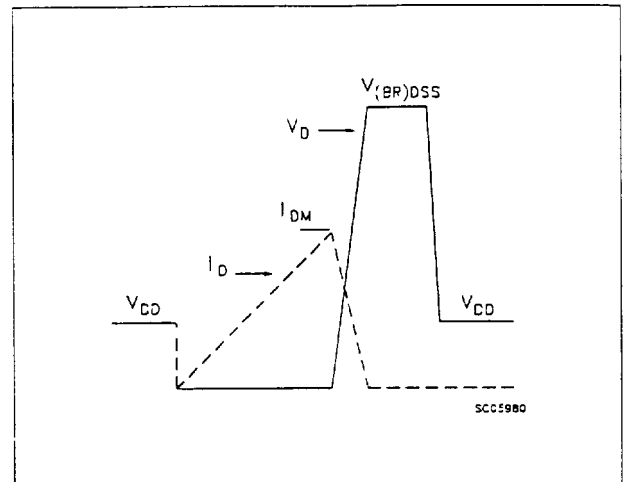

Fig. 3: Switching Times Test Circuits For Resistive Load

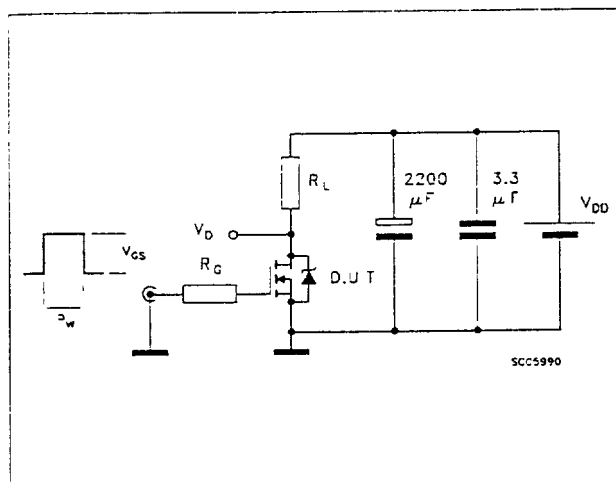

Fig. 4: Gate Charge Test Circuit

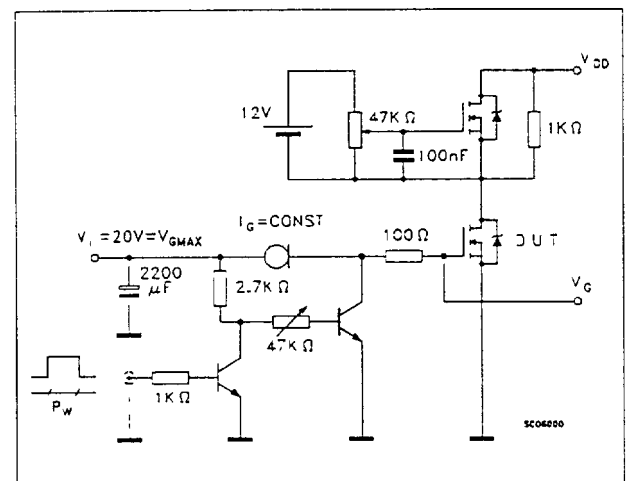

Fig. 5: Test Circuit For Inductive Load Switching And Diode Reverse Recovery Time

