

**SANYO****STK4201 II****2ch AF Power Amplifier (Split Power Supply)  
(60W + 60W min, THD = 0.4%)****Features**

- Muting circuit built-in to isolate all types of shock noise
- Current mirror circuit for low 0.4% total harmonic distortion
- Pin compatible with the STK4201V series (THD=0.08%) and the STK4141X series (THD=0.02%)

**Package Dimensions**

unit:mm

4086A

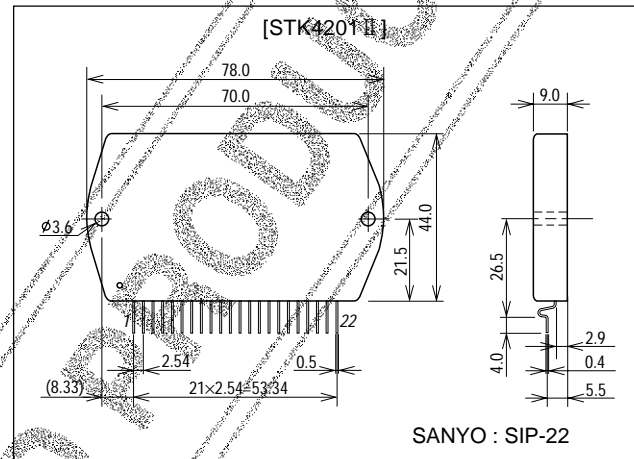
**Specifications****Maximum Ratings** at  $T_a = 25^\circ\text{C}$ 

Parameter	Symbol	Conditions	Ratings	Unit
Maximum supply voltage	$V_{CC\text{ max}}$		$\pm 55$	V
Thermal resistance	$\theta_{j-c}$		1.5	$^\circ\text{C}/\text{W}$
Junction temperature	$T_j$		150	$^\circ\text{C}$
Operating substrate temperature	$T_c$		125	$^\circ\text{C}$
Storage temperature	$T_{stg}$		-30 to +125	$^\circ\text{C}$
Available time for load short-circuit	$t_s$	$V_{CC} = \pm 38\text{V}$ , $R_L = 8\Omega$ , $f = 50\text{Hz}$ , $P_O = 60\text{W}$	1	s

**Recommended Operating Conditions** at  $T_a = 25^\circ\text{C}$ 

Parameter	Symbol	Conditions	Ratings	Unit
Recommended supply voltage	$V_{CC}$		$\pm 38$	V
Load resistance	$R_L$		8	$\Omega$

■ Any and all SANYO products described or contained herein do not have specifications that can handle applications that require extremely high levels of reliability, such as life-support systems, aircraft's control systems, or other applications whose failure can be reasonably expected to result in serious physical and/or material damage. Consult with your SANYO representative nearest you before using any SANYO products described or contained herein in such applications.

■ SANYO assumes no responsibility for equipment failures that result from using products at values that exceed, even momentarily, rated values (such as maximum ratings, operating condition ranges, or other parameters) listed in products specifications of any and all SANYO products described or contained herein.

**SANYO Electric Co.,Ltd. Semiconductor Company**

TOKYO OFFICE Tokyo Bldg., 1-10, 1 Chome, Ueno, Taito-ku, TOKYO, 110-8534 JAPAN

# STK4201 II

**Operating Characteristics** at  $T_a = 25^\circ\text{C}$ ,  $V_{CC} = \pm 38\text{V}$ ,  $R_L = 8\Omega$  (noninductive load),  $R_g = 600\Omega$ ,  $V_G = 40\text{dB}$

Parameter	Symbol	Conditions	Ratings			Unit
			min	typ	max	
Quiescent current	$I_{CCO}$	$V_{CC} = \pm 46\text{V}$	20	40	100	mA
Output power	$P_O$	THD=0.4%, $f = 20\text{Hz}$ to $20\text{kHz}$	60			W
Total harmonic distortion	THD	$P_O = 1.0\text{W}$ , $f = 1\text{kHz}$			0.3	%
Frequency response	$f_L, f_H$	$P_O = 1.0\text{W}$ , $\pm 3\text{dB}$		20 to 50k		Hz
Input impedance	$r_i$	$P_O = 1.0\text{W}$ , $f = 1\text{kHz}$		55		$k\Omega$
Output noise voltage	$V_{NO}$	$V_{CC} = \pm 46\text{V}$ , $R_g = 10k\Omega$			1.2	mVrms
Neutral voltage	$V_N$	$V_{CC} = \pm 46\text{V}$	-70	0	+70	mV
Muting voltage	$V_M$		-2	-5	-10	V

Note.

All tests are made using a constant-voltage supply unless otherwise specified.

Available time for load short-circuit and output noise voltage are measured using the transformer supply specified below. The output noise voltage is the peak value of an average-reading meter with an rms value scale (VTVM). A regulated AC supply (50Hz) should be used to eliminate the effects of AC primary line flicker noise.

## Specified Transformer Supply (MG-200 or Equivalent)

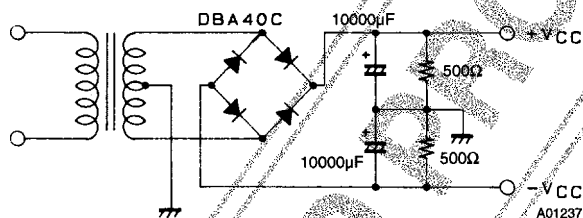

## Equivalent Circuit

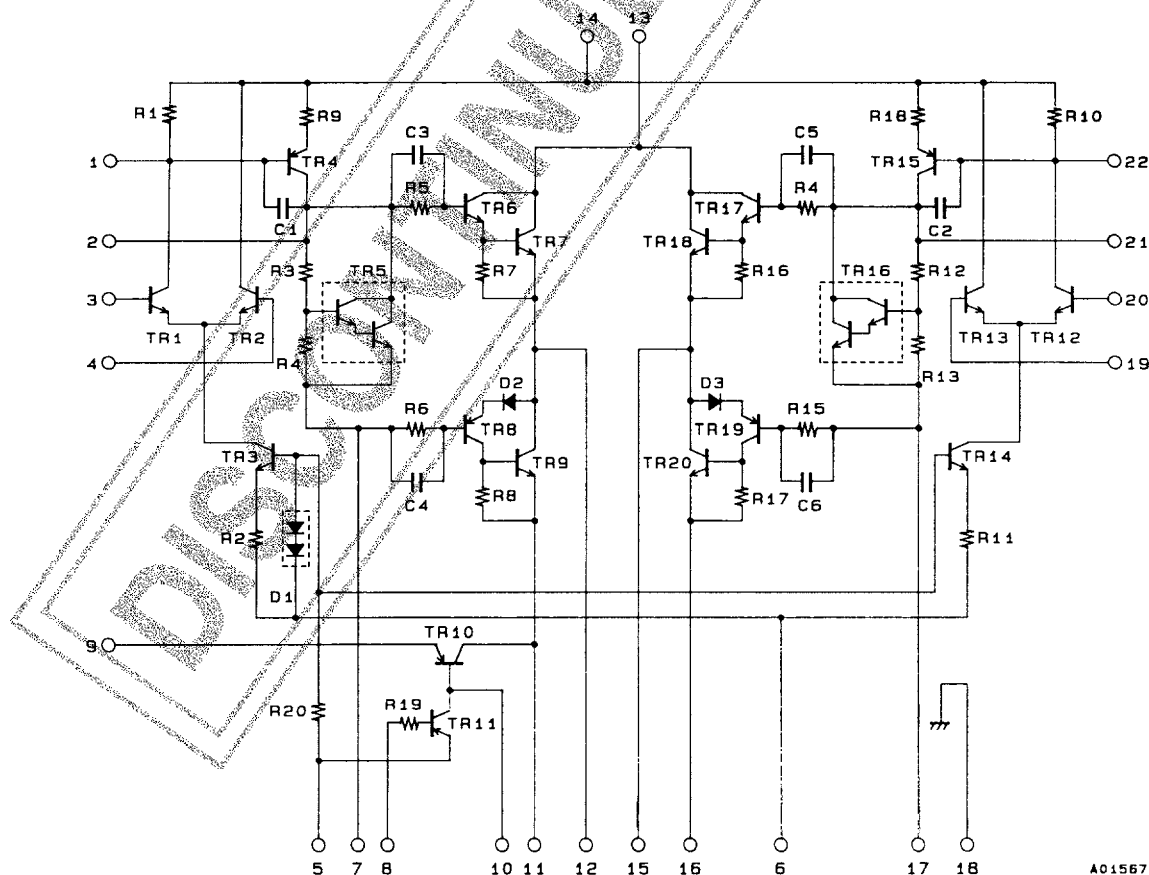

# STK4201 II

## Sample Application Circuit (60W min, 2-Channel, AF Power Amplifier)

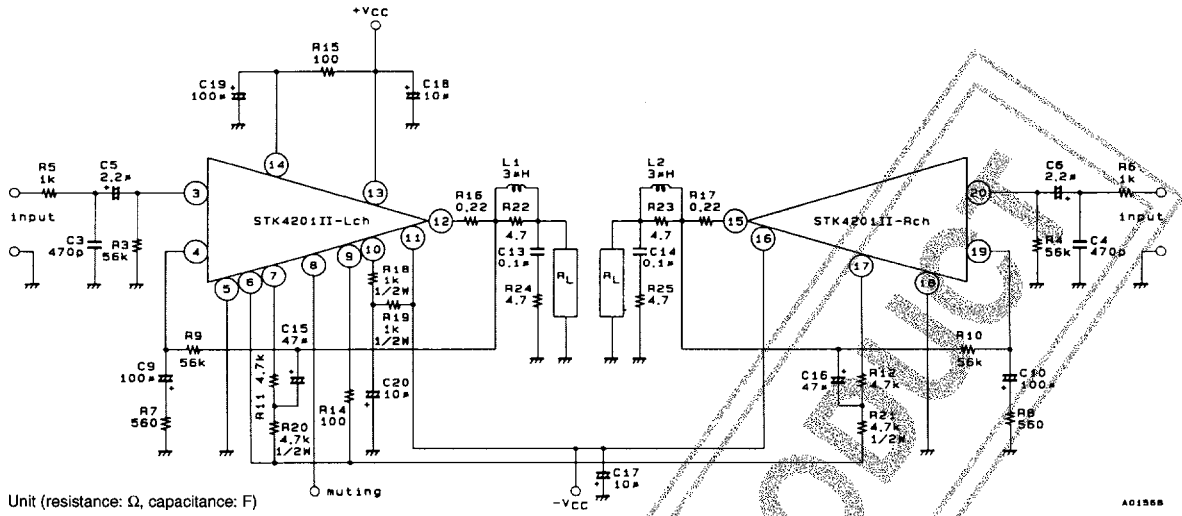

## Sample Application Circuit PCB Layout (Copper Foil Surface)

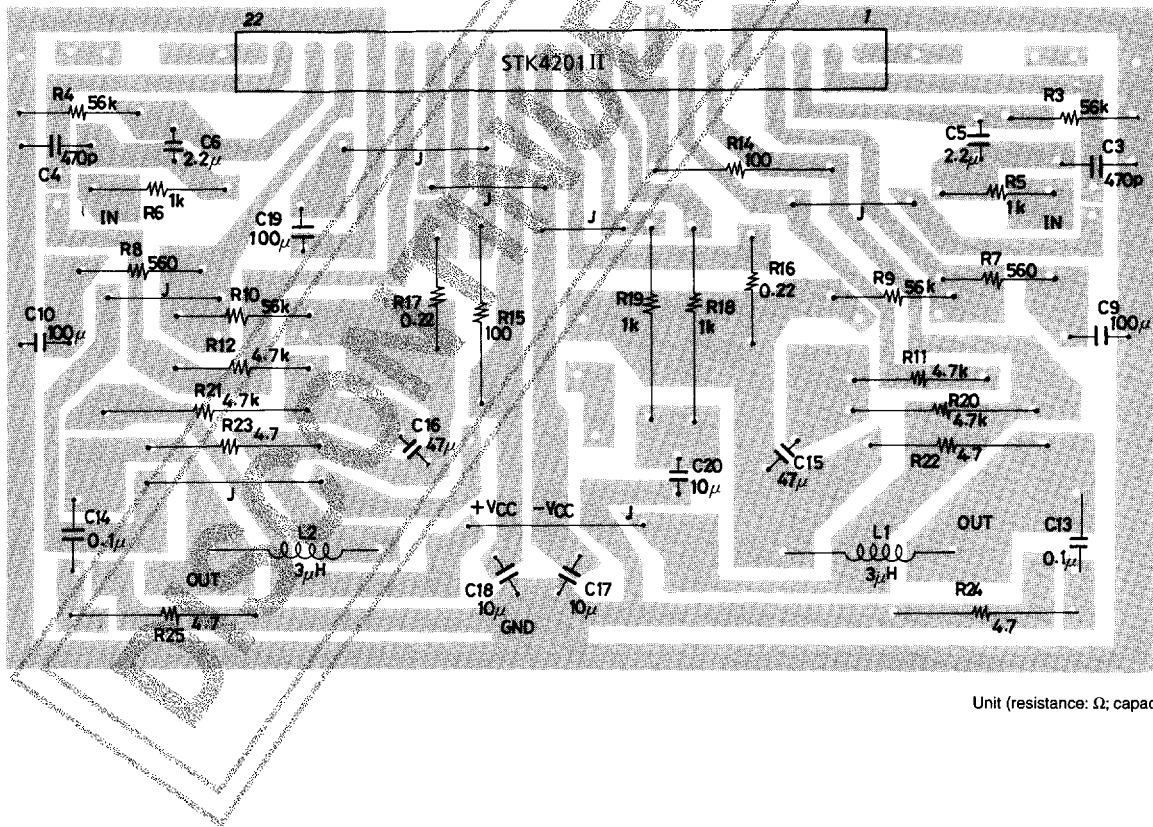

External Component Description

C3, C4	Input filter capacitors. These, together with R5 and R6, form filters to reduce high-band noise.
C5, C6	Input coupling capacitors. For DC blocking. Since capacitor reactance becomes larger at lower frequencies, the output noise can be adversely affected by signal source resistance-dependent 1/f noise. In this case, a lower reactance value should be chosen. In order to remove pop noise at power-on, larger values of capacitance should be chosen for C5 and C6, which determine the input time constant, and smaller values for C9 and C10 in the NF circuit.
C9, C10	NF capacitors. These determine the low-side cutoff frequency. $f_L = \frac{1}{2\pi \times C9 \times R7} \text{ [Hz]}$ A large values should be chosen for C9 to maintain voltage gain at low frequencies. However, because this would tend to increase the shock noise at power-on, a values larger than absolutely necessary should be avoided.
C19	Decoupling capacitors. This removes shock noise and ripple voltage from the supply.
C15, C16	Bootstrap capacitors. If these capacitors are made small, then the total harmonic distortion at low frequencies increases significantly.
C17, C18	Oscillation prevention capacitors. These should be inserted as close as possible to the IC supply pins to reduce supply impedance and hence provide stable IC operation. Electrolytic capacitors are recommended.
C20	Ripple filter capacitor. This forms a ripple filter in combinatin with internal transistor TR10.
C13, C14	Oscillation prevention capacitors. Mylar capacitors are recommended for their excellent thermal and frequency characteristics.
R5, R6	Input filter resistors.
R3, R4	Input bias resistors. These are used to bias the input pins at aero potential. The input impedance is largely determined by this resistance.
R7, R9 (R8, R10)	Voltage-gain VG setting resistors. VG=40dB is recommended using R7, R8=560kΩ, and R9, R10=56kΩ. Gain adjustments are best made using R7 and R8. If gain adjustments are made using R7 and R8, then set R3, R4=R9, R10 to maintain V <sub>N</sub> balance stability.
R11, R20 (R12, R21)	Bootstrap resistors. These resistors determine the quiescent current. Values of 4.7kΩ and 4.7kΩ are recommended.
R15	Ripple filter tesistor. This resistor performs as predriver transistor limiting resistor during load short circuits.
R14	Clipping plus/minus balance resistor.
R18, R19	Ripple filter resistors. When muting transistor TR11 is on, current flows from ground through TR11 to -V <sub>CC</sub> . Values of 1kΩ (1W) and 1kΩ (1W) are recommended.
R24, R25	Oscillation prevention resistors.
R16, R17	Output limiting resistors.
R22, R23	High-frequency oscillation prevention resistors.
L1, L2	High-frequency oscillation prevention inductors.



Sample Application Circuit (With Protection and Muting Circuit)

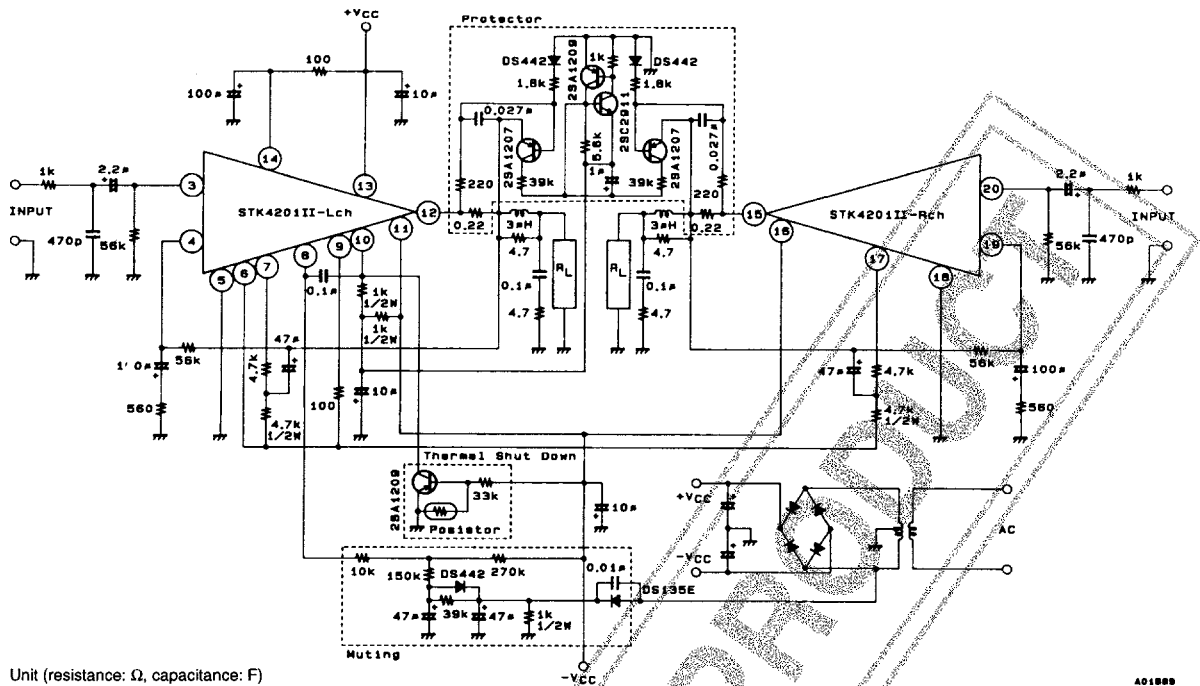

Unit (resistance: Ω, capacitance: F)

401888

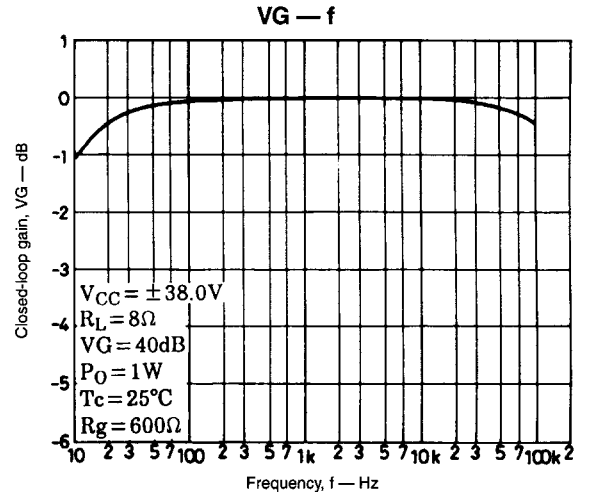
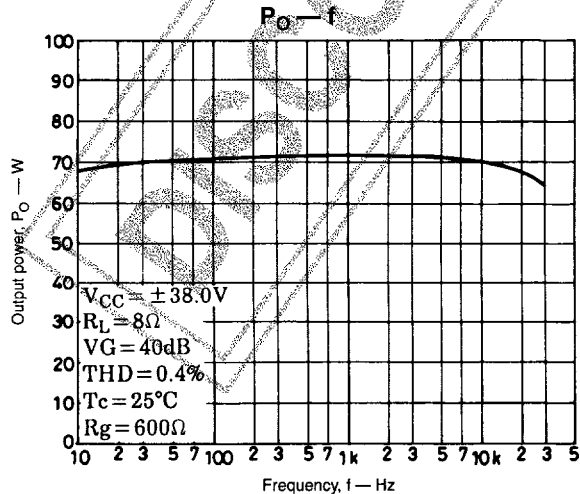
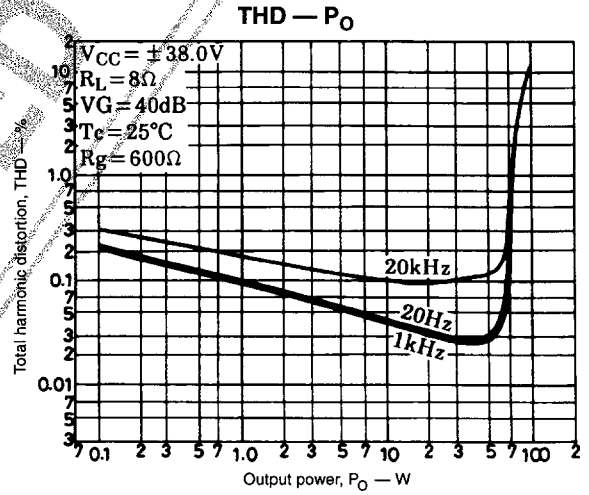
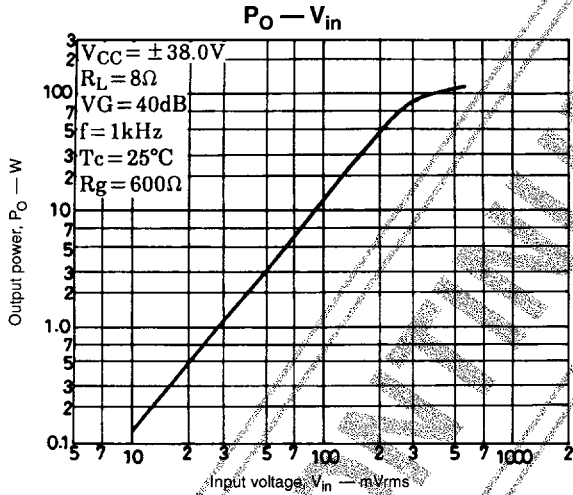

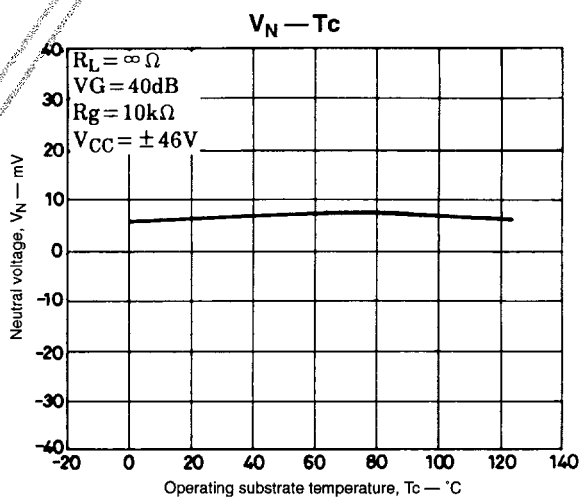
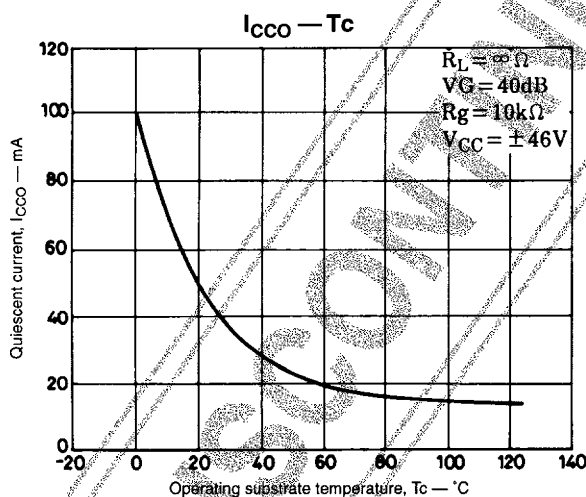
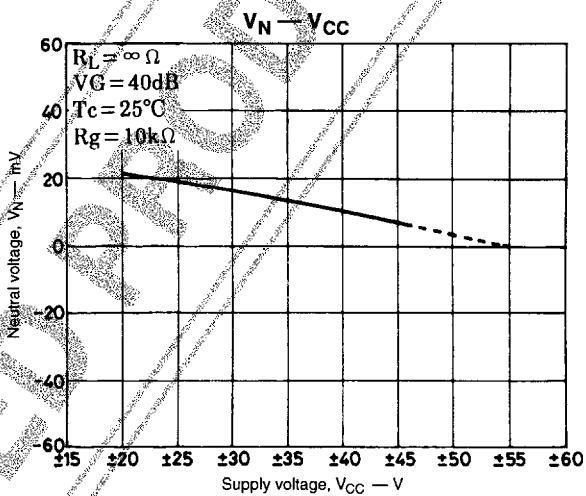
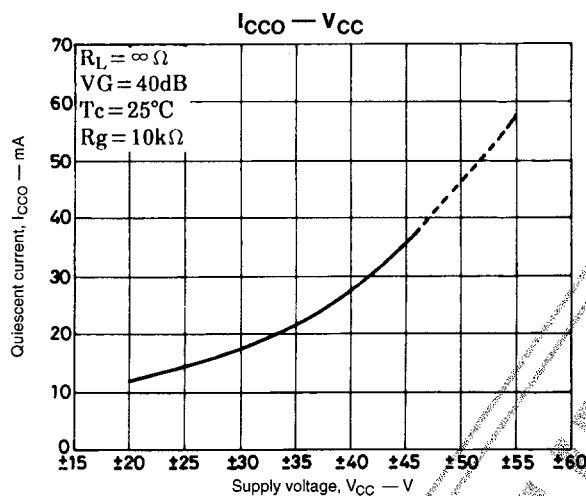
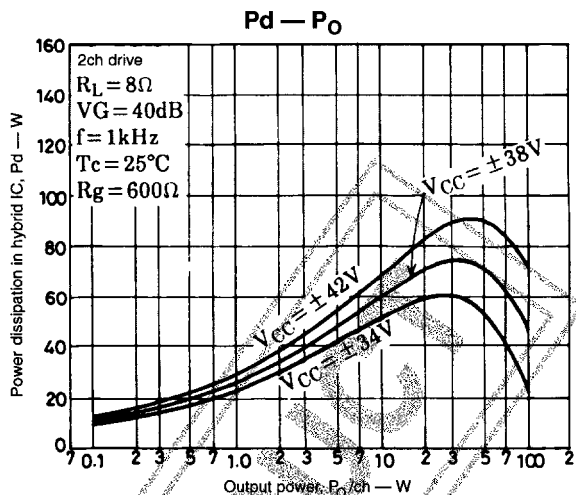
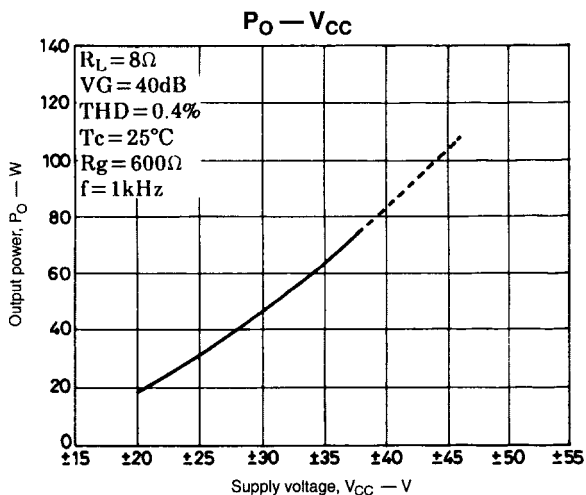

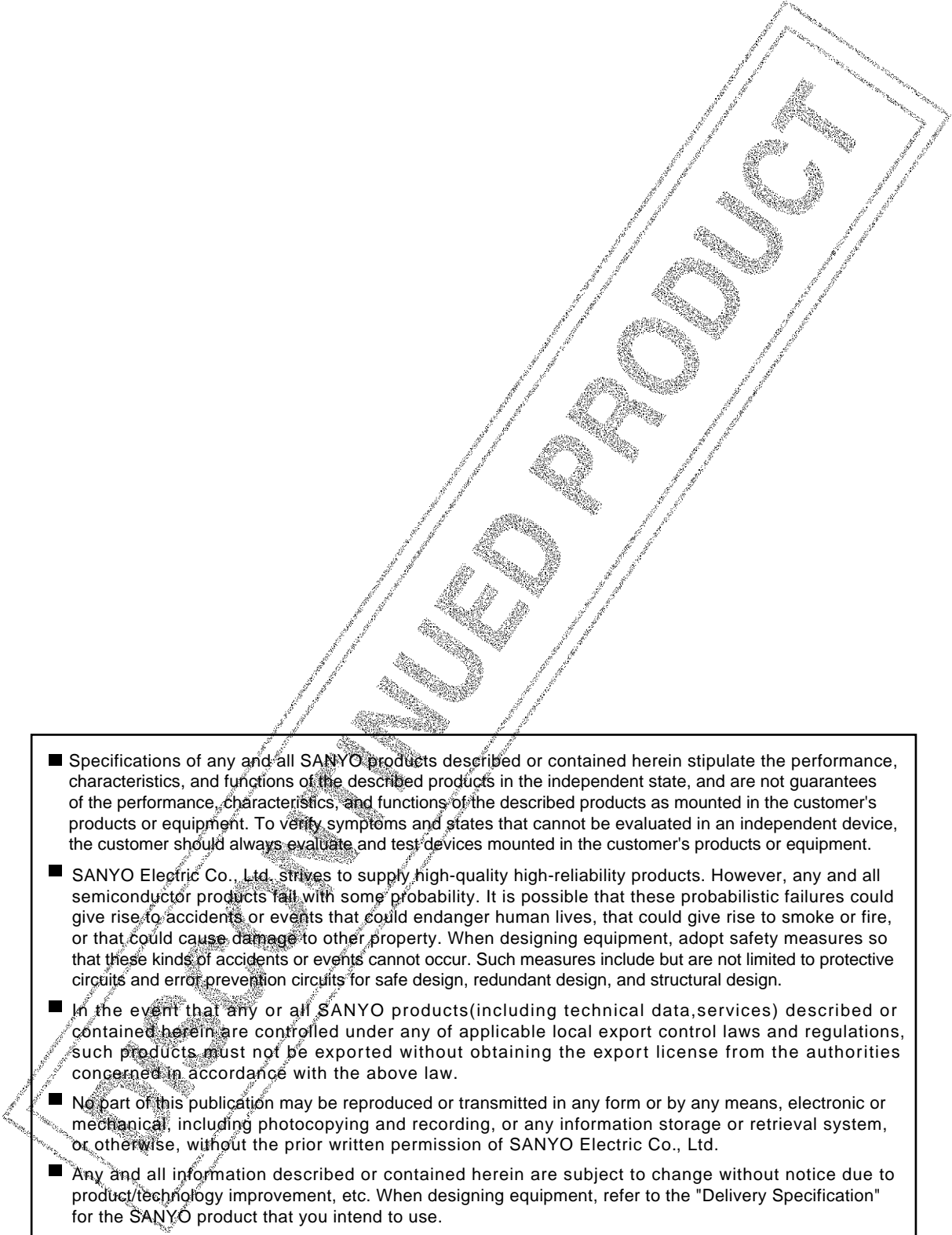
- 
- Specifications of any and all SANYO products described or contained herein stipulate the performance, characteristics, and functions of the described products in the independent state, and are not guarantees of the performance, characteristics, and functions of the described products as mounted in the customer's products or equipment. To verify symptoms and states that cannot be evaluated in an independent device, the customer should always evaluate and test devices mounted in the customer's products or equipment.
  - SANYO Electric Co., Ltd. strives to supply high-quality high-reliability products. However, any and all semiconductor products fail with some probability. It is possible that these probabilistic failures could give rise to accidents or events that could endanger human lives, that could give rise to smoke or fire, or that could cause damage to other property. When designing equipment, adopt safety measures so that these kinds of accidents or events cannot occur. Such measures include but are not limited to protective circuits and error prevention circuits for safe design, redundant design, and structural design.
  - In the event that any or all SANYO products(including technical data, services) described or contained herein are controlled under any of applicable local export control laws and regulations, such products must not be exported without obtaining the export license from the authorities concerned in accordance with the above law.
  - No part of this publication may be reproduced or transmitted in any form or by any means, electronic or mechanical, including photocopying and recording, or any information storage or retrieval system, or otherwise, without the prior written permission of SANYO Electric Co., Ltd.
  - Any and all information described or contained herein are subject to change without notice due to product/technology improvement, etc. When designing equipment, refer to the "Delivery Specification" for the SANYO product that you intend to use.
  - Information (including circuit diagrams and circuit parameters) herein is for example only ; it is not guaranteed for volume production. SANYO believes information herein is accurate and reliable, but no guarantees are made or implied regarding its use or any infringements of intellectual property rights or other rights of third parties.

This catalog provides information as of October, 1999. Specifications and information herein are subject to change without notice.