

Features

- Avalanche rugged technology.
- Low input capacitance.
- Low leakage current : 10 μA (Max.) @ $V_{\text{DS}}=200\text{V}$.
- Low $R_{\text{DS(on)}}$: 0.40 Ω (Max.)

Ordering Information

Type NO.	Marking	Package Code
STK630F	STK630	TO-220F-3L

Outline Dimensions

unit : mm

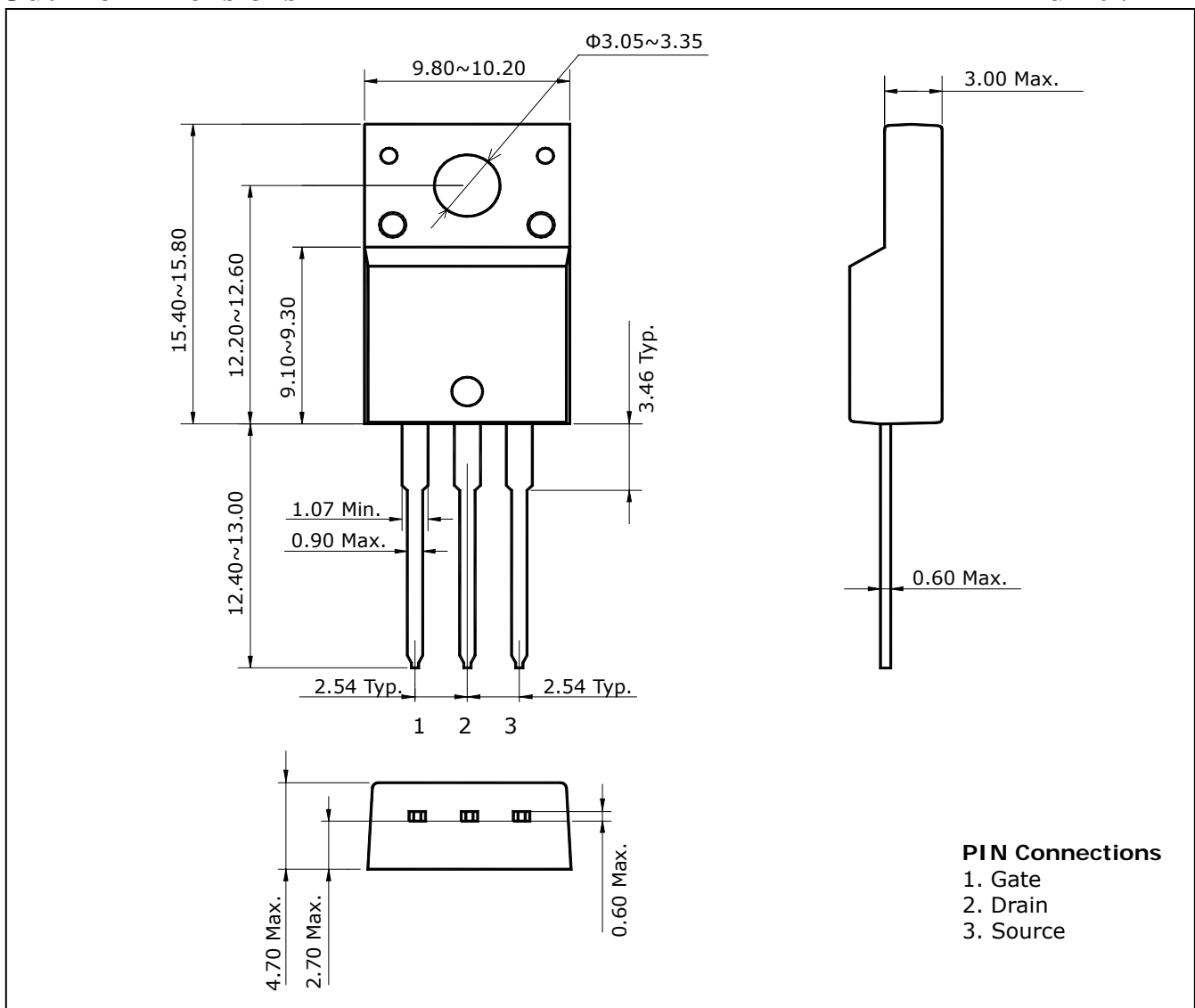

Absolute maximum ratings

Characteristic	Symbol	Rating		Unit
Drain-source voltage	V_{DSS}	200		V
Gate-source voltage	V_{GSS}	± 30		V
Drain current (DC) *	I_D	$T_C=25^\circ\text{C}$	9	A
		$T_C=100^\circ\text{C}$	5.7	A
Drain current (Pulsed) *	I_{DP}	36		A
Drain power dissipation ($T_C=25^\circ\text{C}$)	P_D	30		W
Single pulsed avalanche energy ②	E_{AS}	54		mJ
Avalanche current (Repetitive) ①	I_{AR}	9		A
Repetitive avalanche energy ①	E_{AR}	7.2		mJ
Junction temperature	T_J	150		$^\circ\text{C}$
Storage temperature range	T_{stg}	-55~150		$^\circ\text{C}$

* Limited by maximum junction temperature

Thermal Resistance

Characteristic	Symbol	Typ.	Max.	Units
Thermal resistance junction-case	$R_{th(J-C)}$	-	4.16	$^\circ\text{C}/\text{W}$
Thermal resistance junction-ambient	$R_{th(J-A)}$	-	62.5	

Electrical Characteristics

(Tc=25°C)

Characteristic	Symbol	Test Condition	Min.	Typ.	Max.	Unit
Drain-source breakdown voltage	$V_{(BR)DSS}$	$I_D=250 \mu A, V_{GS}=0V$	200	-	-	V
Gate threshold voltage	$V_{GS(th)}$	$I_D=250 \mu A, V_{DS}=V_{GS}$	2.0	-	4.0	V
Drain-source cut-off current	I_{DSS}	$V_{DS}=200V, V_{GS}=0V$	-	-	10	μA
Gate leakage current	I_{GSS}	$V_{DS}=0V, V_{GS}=\pm 30V$	-	-	± 100	nA
Static drain-source on-resistance	$R_{DS(on)}$	$V_{GS}=10V, I_D=4.5A$ ③	-	-	0.4	Ω
Forward transfer conductance	g_{fs}	$V_{DS}=40V, I_D=4.5A$ ③	-	3.87	-	S
Input capacitance	C_{iss}	$V_{GS}=0V, V_{DS}=25V$ $f=1 \text{ MHz}$	-	423	-	pF
Output capacitance	C_{oss}		-	80	-	
Reverse transfer capacitance	C_{rss}		-	15	-	
Turn-on delay time	$t_{d(on)}$	$V_{DD}=100V, I_D=9A$ $R_G=12\Omega$ Fig 13. ③④	-	13	-	ns
Rise time	t_r		-	13	-	
Turn-off delay time	$t_{d(off)}$		-	30	-	
Fall time	t_f		-	18	-	
Total gate charge	Q_g	$V_{DS}=160V, V_{GS}=10V,$ $I_D=9A$ Fig 12. ③④	-	18	-	nC
Gate-source charge	Q_{gs}		-	3.5	-	
Gate-drain charge	Q_{gd}		-	6.5	-	

Source-Drain Diode Ratings and Characteristics

(Tc=25°C)

Characteristic	Symbol	Test Condition	Min	Typ	Max	Units
Source current (DC)	I_S	Integral reverse diode in the MOSFET	-	-	9	A
Source current (Pulsed) ①	I_{SP}		-	-	36	
Diode forward voltage ④	V_{SD}	$V_{GS}=0V, I_S=9A$	-	-	1.5	V
Reverse recovery time	t_{rr}	$I_S=9A, V_{GS}=0V$ $dI_S/dt=100A/\mu s$ ④	-	140	-	ns
Reverse recovery charge	Q_{rr}		-	0.87	-	μC

Note ;

- ① Repetitive rating : Pulse width limited by maximum junction temperature
- ② $L=1mH, I_{AS}=9A, V_{DD}=50V, R_G=27\Omega$, starting $T_J=25^\circ C$
- ③ Pulse Test : Pulse Width $\leq 400 \mu s$, Duty cycle $\leq 2\%$
- ④ Essentially independent of operating temperature

Electrical Characteristic Curves

Fig. 1 $I_D - V_{DS}$

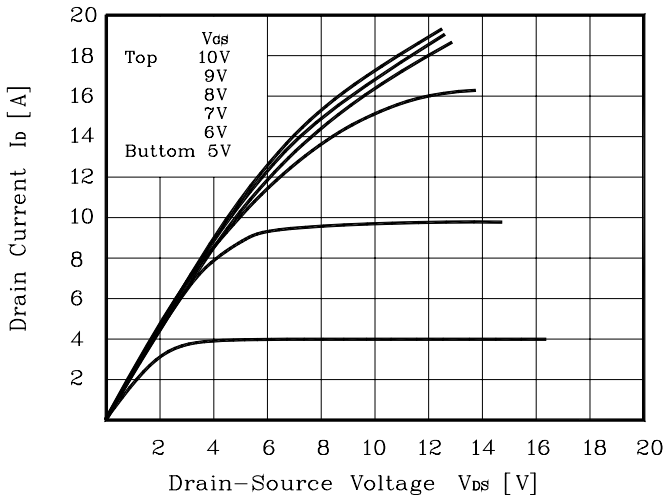

Fig. 2 $I_D - V_{GS}$

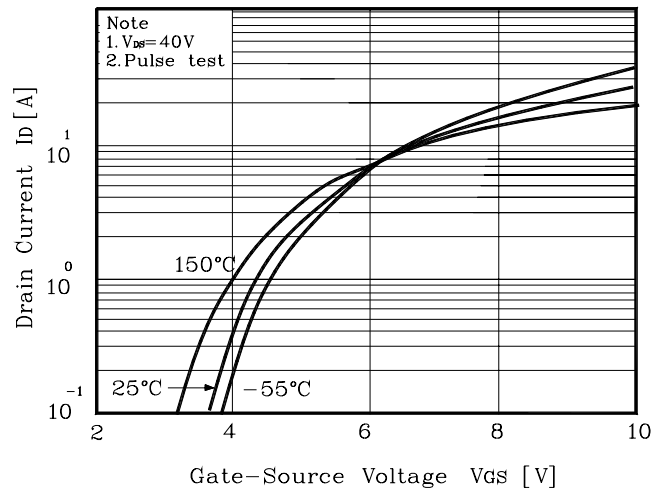

Fig. 3 $R_{DS(on)} - I_D$

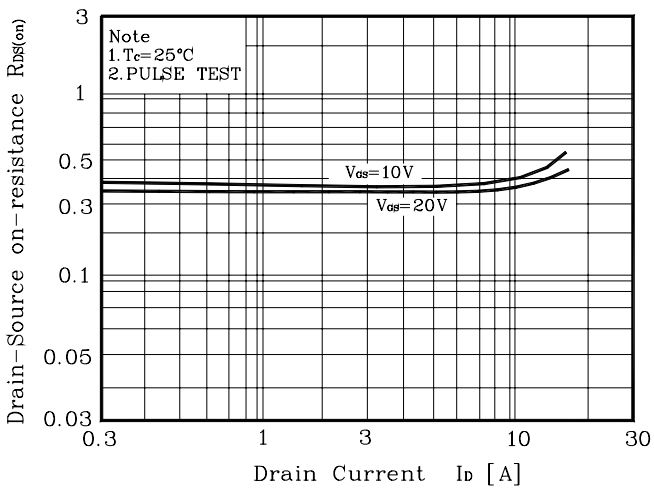

Fig. 4 $I_S - V_{SD}$

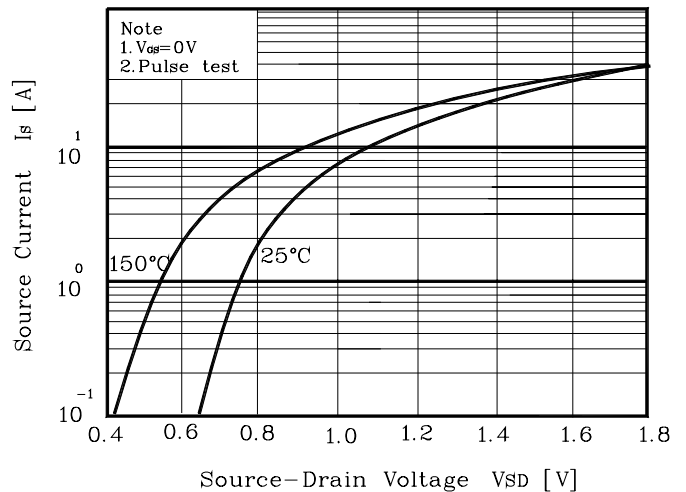

Fig. 5 $V_{GS} - Q_G$

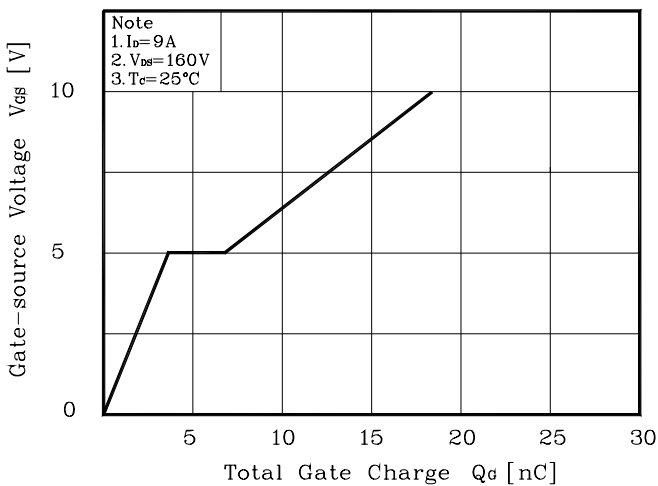

Fig. 6 Capacitance - V_{DS}

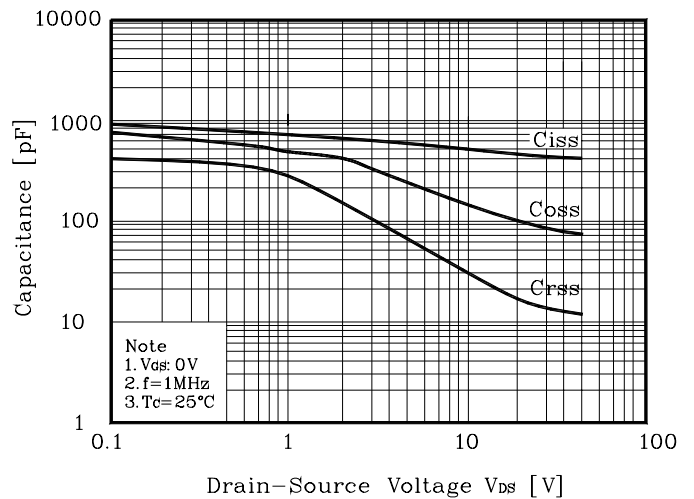

Fig. 7 $V_{(BR)DSS} - T_J$

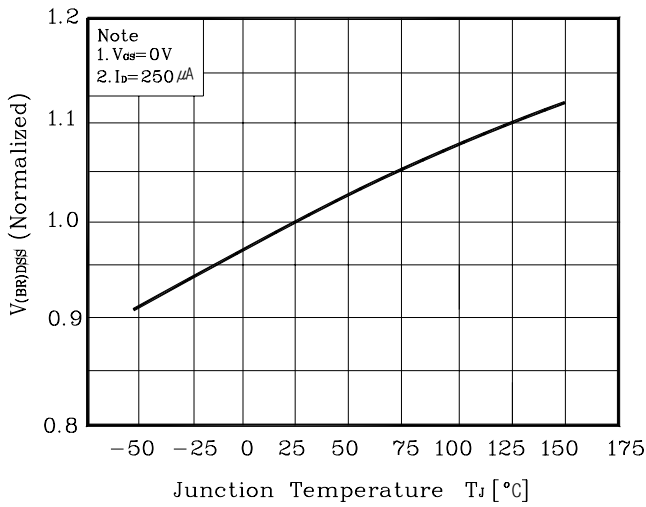

Fig. 8 $R_{DS(on)} - T_J$

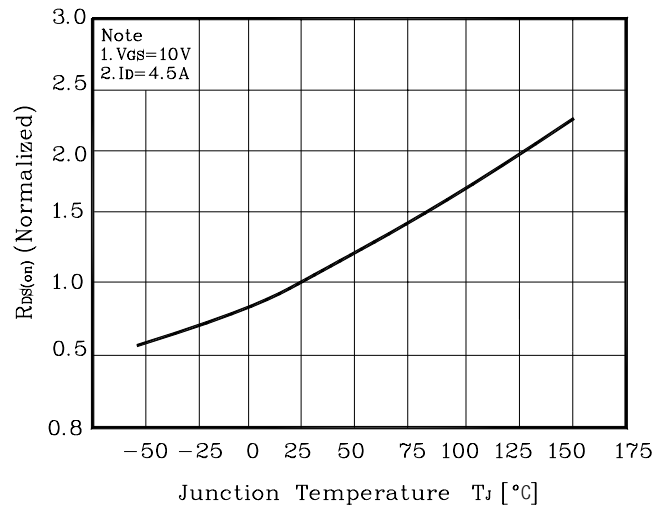

Fig. 9 $I_D - T_C$

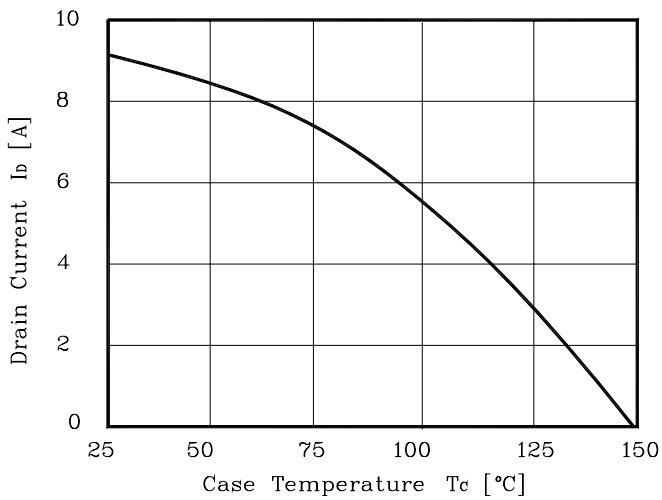

Fig. 10 Safe operating Area

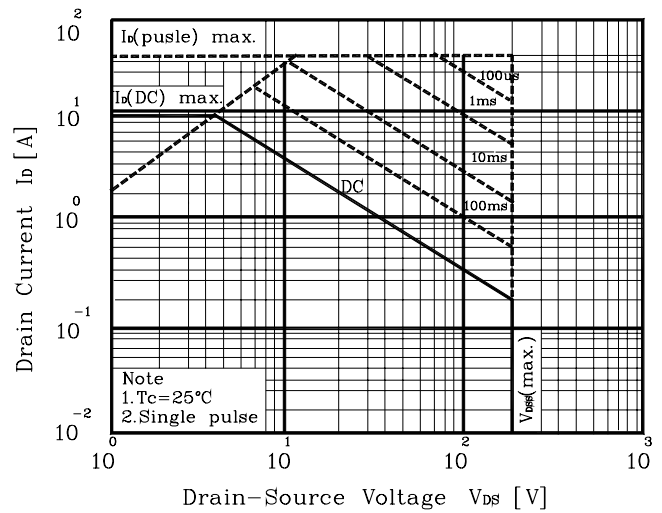

Fig. 11 Thermal Response

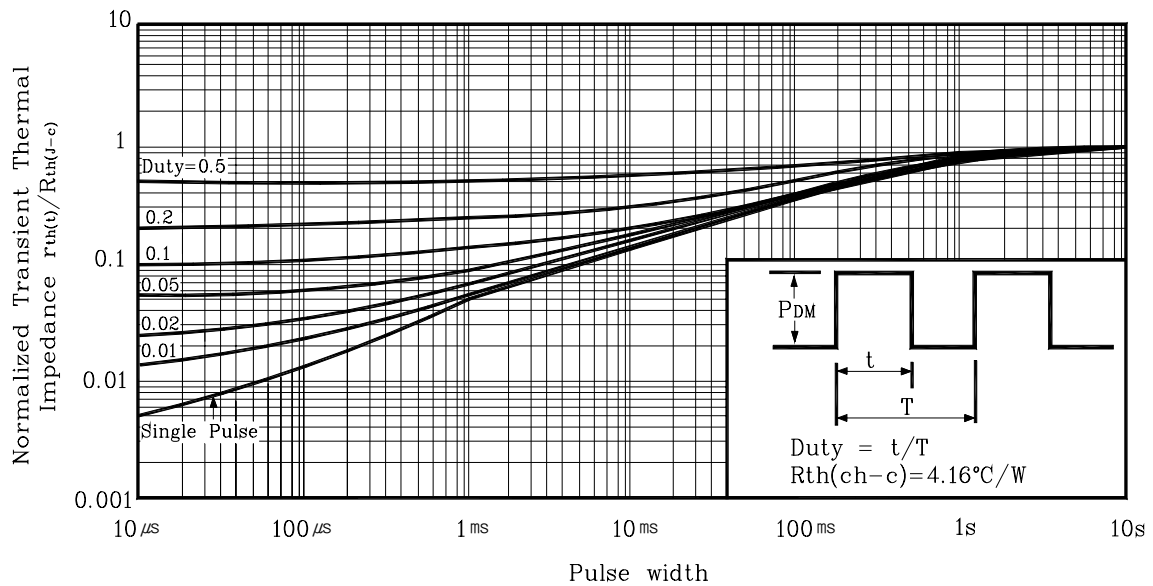

Fig. 12 Gate Charge Test Circuit & Waveform

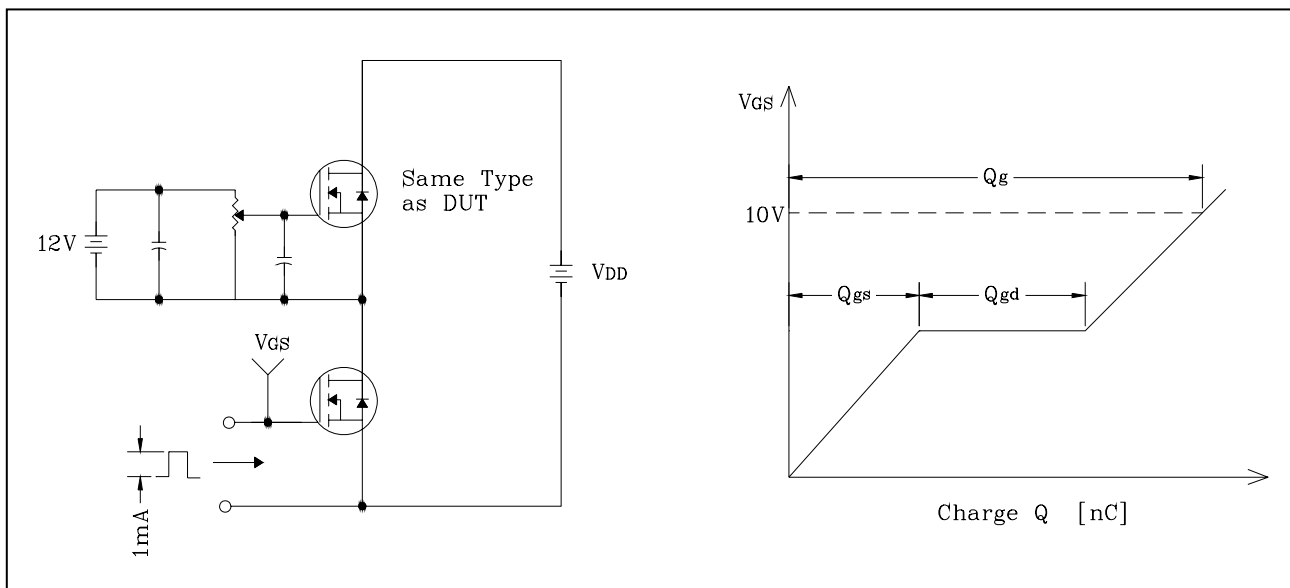

Fig. 13 Switching Time Test Circuit & Waveform

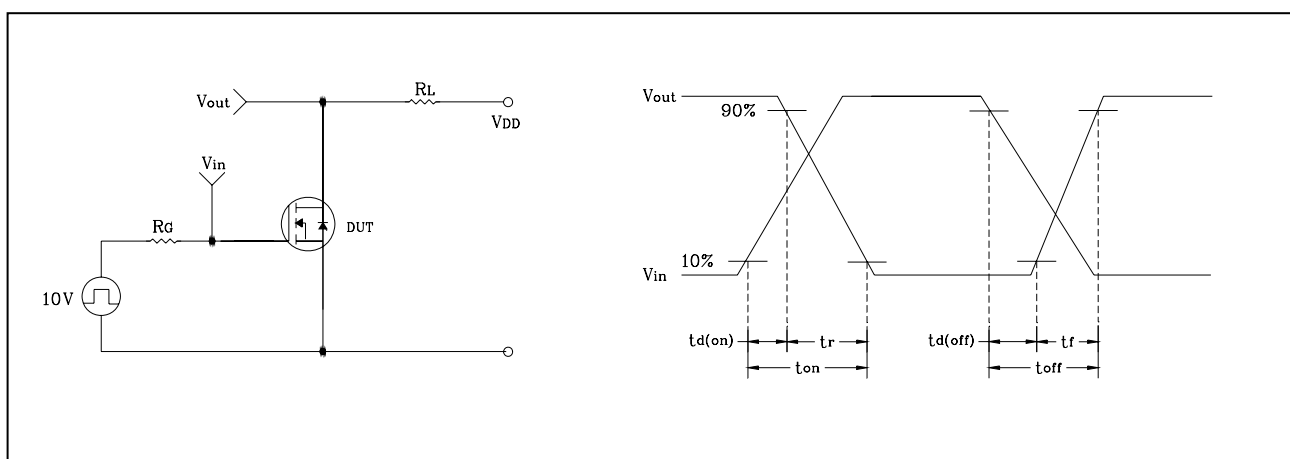

Fig. 14 E_{AS} Test Circuit & Waveform

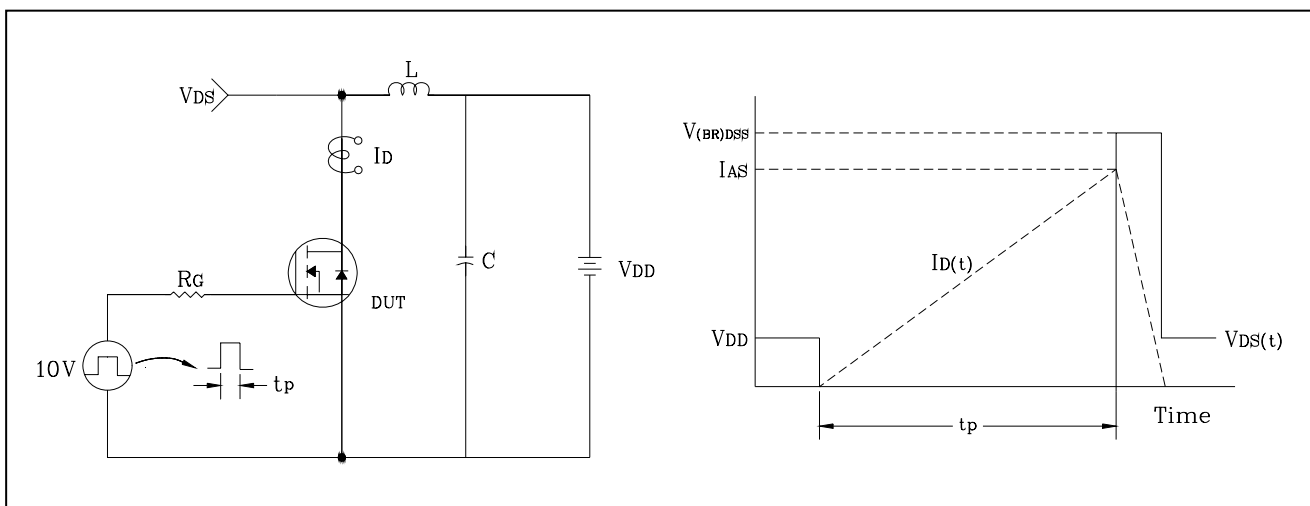
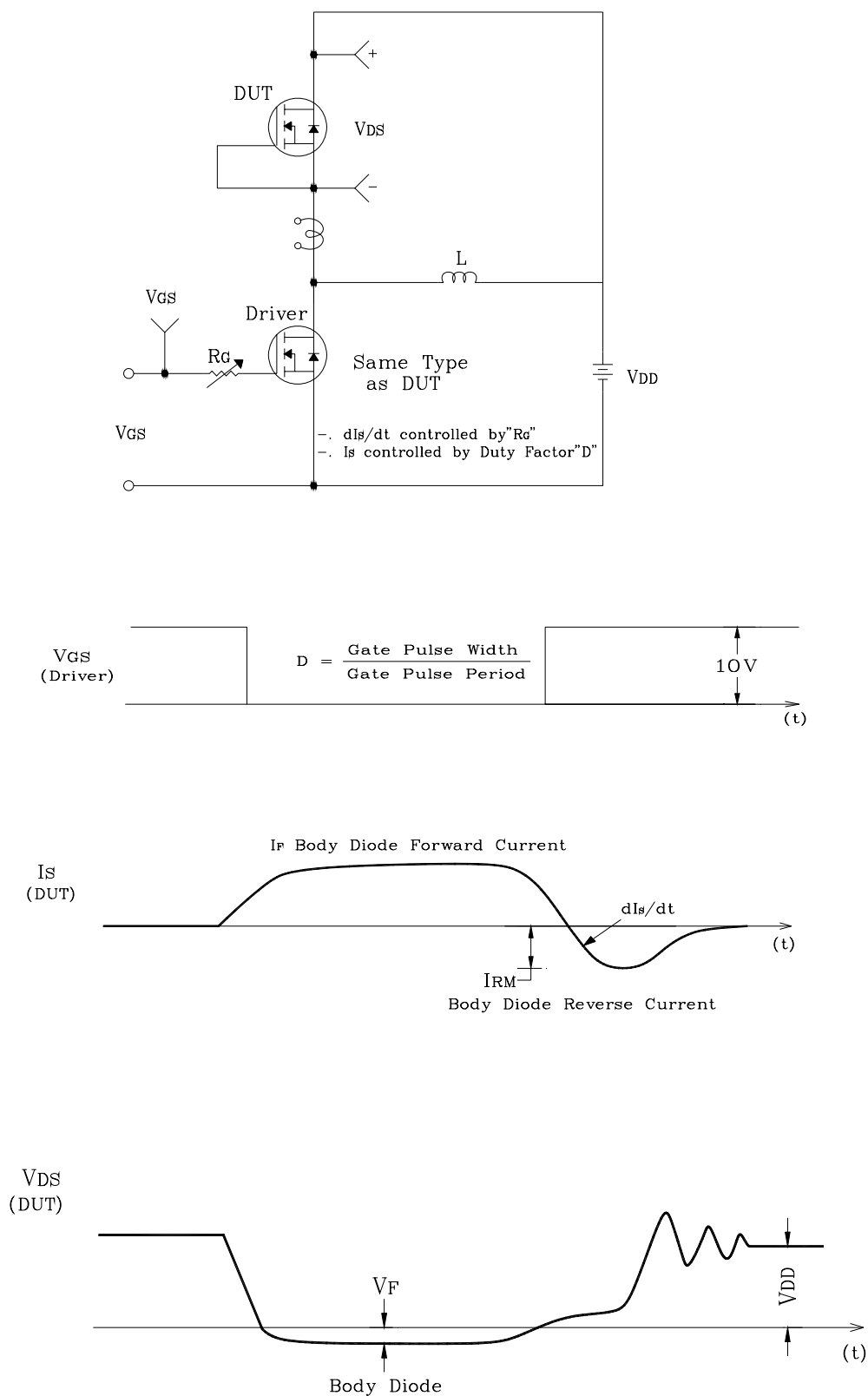

Fig. 15 Peak Diode Recovery dv/dt Test Circuit & Waveform



The AUK Corp. products are intended for the use as components in general electronic equipment (Office and communication equipment, measuring equipment, home appliance, etc.).

Please make sure that you consult with us before you use these AUK Corp. products in equipments which require high quality and / or reliability, and in equipments which could have major impact to the welfare of human life(atomic energy control, airplane, spaceship, transportation, combustion control, all types of safety device, etc.). AUK Corp. cannot accept liability to any damage which may occur in case these AUK Corp. products were used in the mentioned equipments without prior consultation with AUK Corp..

Specifications mentioned in this publication are subject to change without notice.