



# STP70NF03L STB70NF03L-1

N-CHANNEL 30V - 0.008Ω - 70A TO-220/I<sup>2</sup>PAK  
LOW GATE CHARGE STripFET™ POWER MOSFET

TYPE	V <sub>DSS</sub>	R <sub>DS(on)</sub>	I <sub>D</sub>
STP70NF03L	30 V	< 0.01 Ω	70 A
STB70NF03L-1	30 V	< 0.01 Ω	70 A

- TYPICAL R<sub>DS(on)</sub> = 0.008 Ω
- TYPICAL Q<sub>g</sub> = 35 nC @ 10 V
- OPTIMAL R<sub>DS(on)</sub> x Q<sub>g</sub> TRADE-OFF
- CONDUCTION LOSSES REDUCED
- SWITCHING LOSSES REDUCED

## DESCRIPTION

This application specific Power Mosfet is the third generation of STMicroelectronics unique "Single Feature Size™" strip-based process. The resulting transistor shows the best trade-off between on-resistance and gate charge. When used as high and low side in buck regulators, it gives the best performance in terms of both conduction and switching losses. This is extremely important for motherboards where fast switching and high efficiency are of paramount importance.

## APPLICATIONS

- SPECIFICALLY DESIGNED AND OPTIMISED FOR HIGH EFFICIENCY CPU CORE DC/DC CONVERTERS

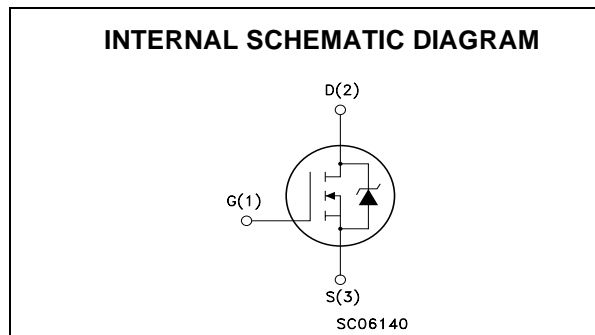
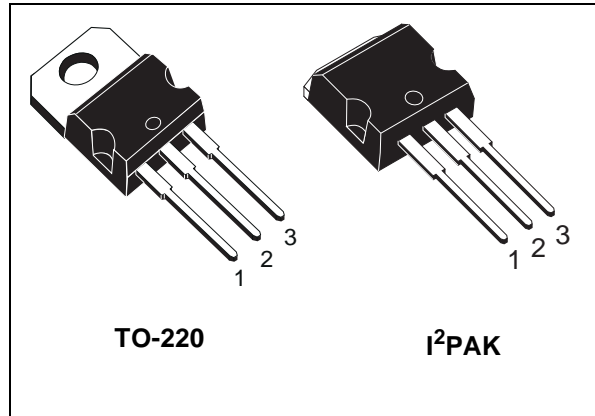

## ABSOLUTE MAXIMUM RATINGS

Symbol	Parameter	Value	Unit
V <sub>DS</sub>	Drain-source Voltage (V <sub>GS</sub> = 0)	30	V
V <sub>DGR</sub>	Drain-gate Voltage (R <sub>GS</sub> = 20 kΩ)	30	V
V <sub>GS</sub>	Gate- source Voltage	± 15	V
I <sub>D</sub>	Drain Current (continuous) at T <sub>C</sub> = 25°C	70	A
I <sub>D</sub>	Drain Current (continuous) at T <sub>C</sub> = 100°C	50	A
I <sub>DM</sub> (●)	Drain Current (pulsed)	280	A
P <sub>TOT</sub>	Total Dissipation at T <sub>C</sub> = 25°C	100	W
	Derating Factor	0.67	W/°C
dv/dt (1)	Peak Diode Recovery voltage slope	4	V/ns
T <sub>stg</sub>	Storage Temperature	-65 to 175	°C
T <sub>j</sub>	Max. Operating Junction Temperature	175	°C

(●) Pulse width limited by safe operating area

(1) I<sub>SD</sub> ≤ 70A, di/dt ≤ 290A/μs, V<sub>DD</sub> = 24 V ; T<sub>j</sub> ≤ T<sub>JMAX</sub>.

## STP70NF03L/STB70NF03L-1

### THERMAL DATA

Rthj-case	Thermal Resistance Junction-case Max	1.5	°C/W
Rthj-amb	Thermal Resistance Junction-ambient Max	62.5	°C/W
T <sub>I</sub>	Maximum Lead Temperature For Soldering Purpose	300	°C

### AVALANCHE CHARACTERISTICS

Symbol	Parameter	Max Value	Unit
I <sub>AR</sub>	Avalanche Current, Repetitive or Not-Repetitive (pulse width limited by T <sub>j</sub> max)	35	A
E <sub>AS</sub>	Single Pulse Avalanche Energy (starting T <sub>j</sub> = 25 °C, I <sub>D</sub> = I <sub>AR</sub> , V <sub>DD</sub> = 50 V)	450	mJ

### ELECTRICAL CHARACTERISTICS (TCASE = 25 °C UNLESS OTHERWISE SPECIFIED) OFF

Symbol	Parameter	Test Conditions	Min.	Typ.	Max.	Unit
V <sub>(BR)DSS</sub>	Drain-source Breakdown Voltage	I <sub>D</sub> = 250 μA, V <sub>GS</sub> = 0	30			V
I <sub>DSS</sub>	Zero Gate Voltage Drain Current (V <sub>GS</sub> = 0)	V <sub>DS</sub> = Max Rating V <sub>DS</sub> = Max Rating, T <sub>C</sub> = 125 °C			1 10	μA μA
I <sub>GSS</sub>	Gate-body Leakage Current (V <sub>DS</sub> = 0)	V <sub>GS</sub> = ± 15V			±100	nA

### ON (1)

Symbol	Parameter	Test Conditions	Min.	Typ.	Max.	Unit
V <sub>GS(th)</sub>	Gate Threshold Voltage	V <sub>DS</sub> = V <sub>GS</sub> , I <sub>D</sub> = 250μA	1	2		V
R <sub>DS(on)</sub>	Static Drain-source On Resistance	V <sub>GS</sub> = 10 V, I <sub>D</sub> = 35 A V <sub>GS</sub> = 5 V, I <sub>D</sub> = 18 A		0.008 0.015	0.01 0.018	Ω Ω
I <sub>D(on)</sub>	On State Drain Current	V <sub>DS</sub> > I <sub>D(on)</sub> × R <sub>DS(on)max</sub> , V <sub>GS</sub> = 10V	70			A

### DYNAMIC

Symbol	Parameter	Test Conditions	Min.	Typ.	Max.	Unit
g <sub>fs</sub> (1)	Forward Transconductance	V <sub>DS</sub> > I <sub>D(on)</sub> × R <sub>DS(on)max</sub> , I <sub>D</sub> = 35 A		40		S
C <sub>iss</sub>	Input Capacitance	V <sub>DS</sub> = 25V, f = 1 MHz, V <sub>GS</sub> = 0		1470		pF
C <sub>oss</sub>	Output Capacitance			490		pF
C <sub>rss</sub>	Reverse Transfer Capacitance			110		pF

**ELECTRICAL CHARACTERISTICS (CONTINUED)**

**SWITCHING ON**

Symbol	Parameter	Test Conditions	Min.	Typ.	Max.	Unit
$t_{d(on)}$	Turn-on Delay Time	$V_{DD} = 15\text{ V}, I_D = 35\text{ A}$ $R_G = 4.7\Omega, V_{GS} = 4.5\text{ V}$ (see test circuit, Figure 3)		20		ns
$t_r$	Rise Time			350		ns
$Q_g$	Total Gate Charge	$V_{DD} = 24\text{ V}, I_D = 46\text{ A},$ $V_{GS} = 10\text{ V}$		35	45	nC
$Q_{gs}$	Gate-Source Charge			5		nC
$Q_{gd}$	Gate-Drain Charge			10		nC

**SWITCHING OFF**

Symbol	Parameter	Test Conditions	Min.	Typ.	Max.	Unit
$t_{d(off)}$	Turn-off-Delay Time	$V_{DD} = 15\text{ V}, I_D = 35\text{ A},$ $R_G = 4.7\Omega, V_{GS} = 4.5\text{ V}$ (see test circuit, Figure 3)		35		ns
$t_f$	Fall Time			65		ns

**SOURCE DRAIN DIODE**

Symbol	Parameter	Test Conditions	Min.	Typ.	Max.	Unit
$I_{SD}$	Source-drain Current				70	A
$I_{SDM(1)}$	Source-drain Current (pulsed)				280	A
$V_{SD(2)}$	Forward On Voltage	$I_{SD} = 70\text{ A}, V_{GS} = 0$			1.5	V
$t_{rr}$	Reverse Recovery Time	$I_{SD} = 70\text{ A}, di/dt = 100\text{ A}/\mu\text{s},$ $V_{DD} = 20\text{ V}, T_j = 150^\circ\text{C}$ (see test circuit, Figure 5)		75		ns
$Q_{rr}$	Reverse Recovery Charge			110		nC
$I_{RRM}$	Reverse Recovery Current			2.9		A

Note: 1. Pulsed: Pulse duration = 300  $\mu\text{s}$ , duty cycle 1.5 %.  
2. Pulse width limited by safe operating area.

**Safe Operating Area**

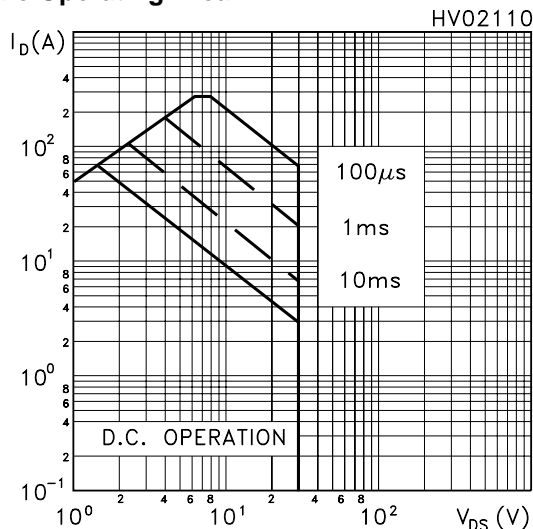

**Thermal Impedance**

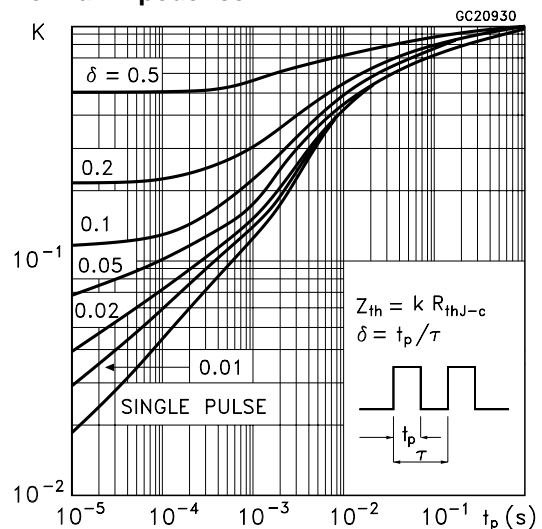

Output Characteristics

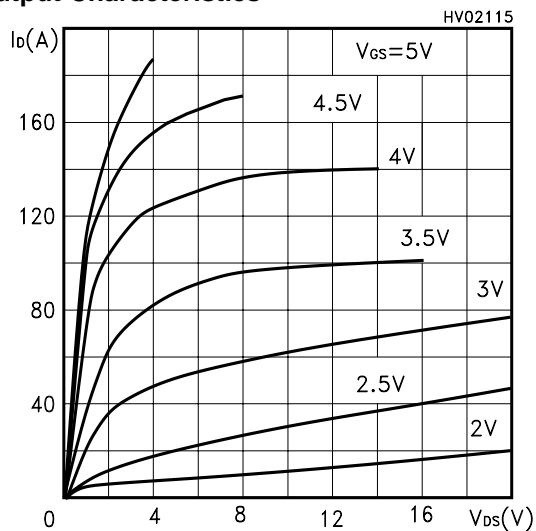

Transfer Characteristics

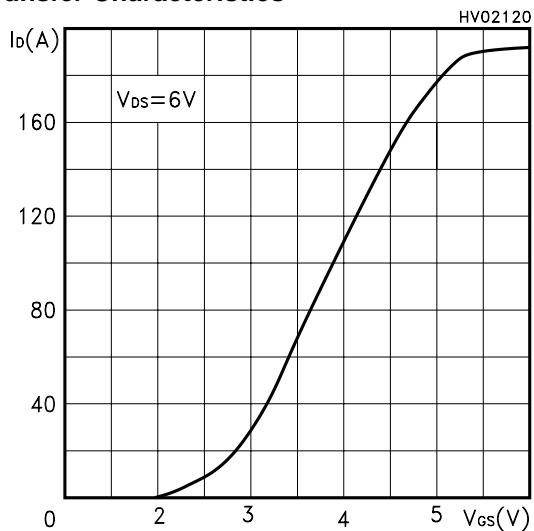

Transconductance

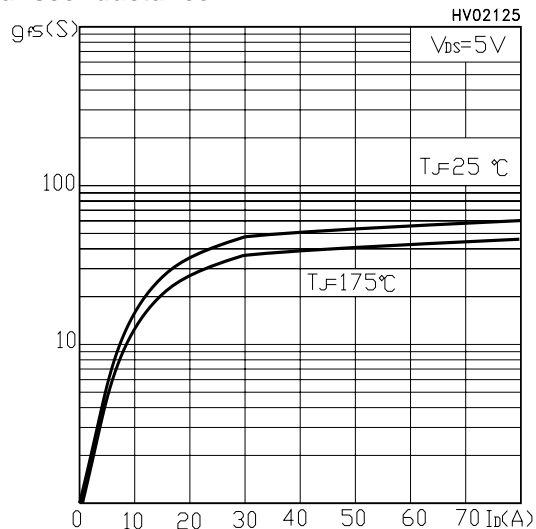

Static Drain-source On Resistance

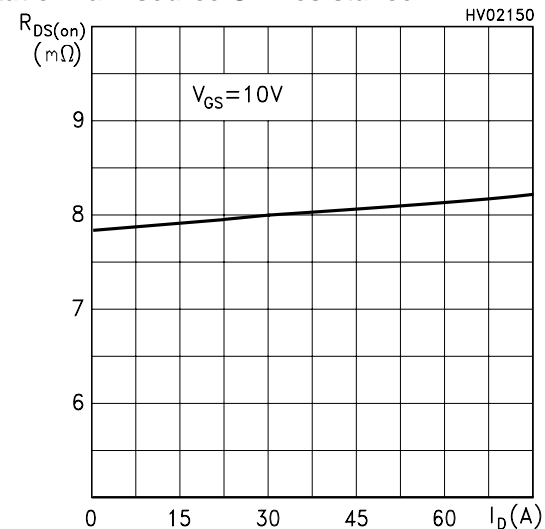

Gate Charge vs Gate-source Voltage

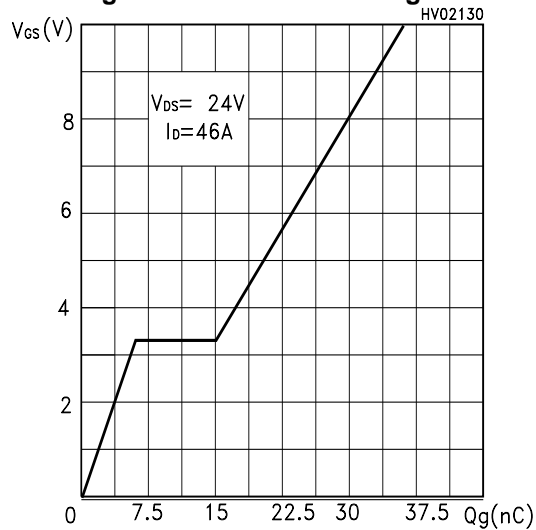

Capacitance Variations

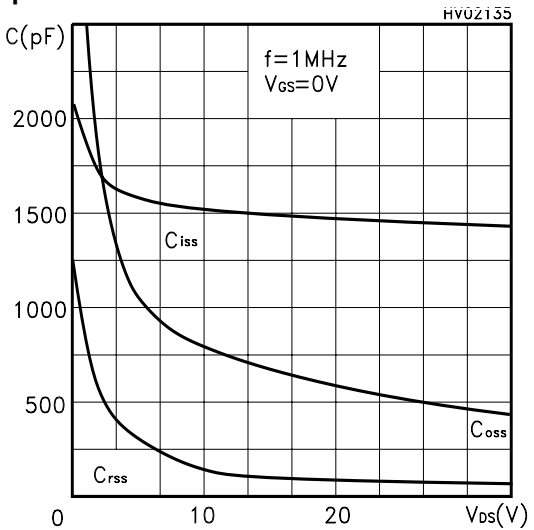

**Normalized Gate Threshold Voltage vs Temperature**

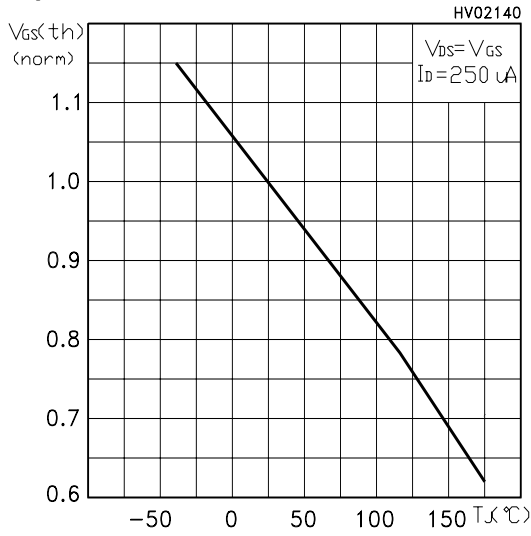

**Normalized On Resistance vs Temperature**

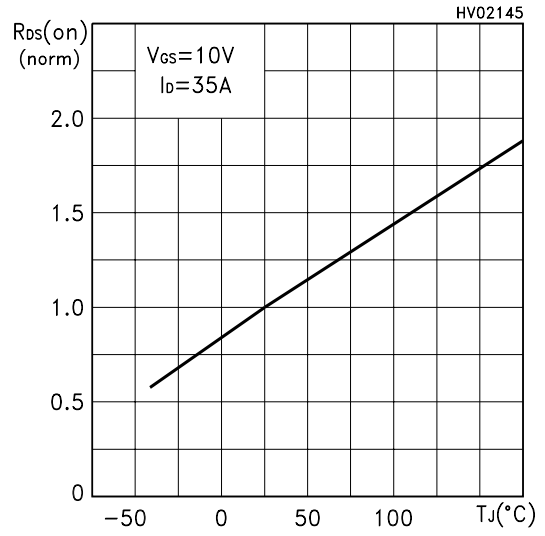

**Source-drain Diode Forward Characteristics**

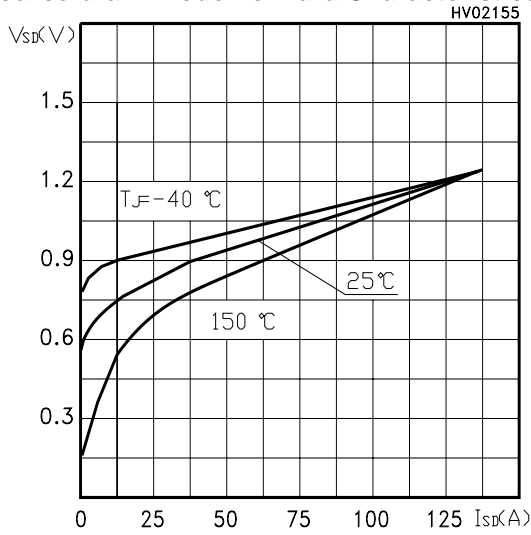

Fig. 1: Unclamped Inductive Load Test Circuit



Fig. 2: Unclamped Inductive Waveform



Fig. 3: Switching Times Test Circuit For Resistive Load



Fig. 4: Gate Charge test Circuit

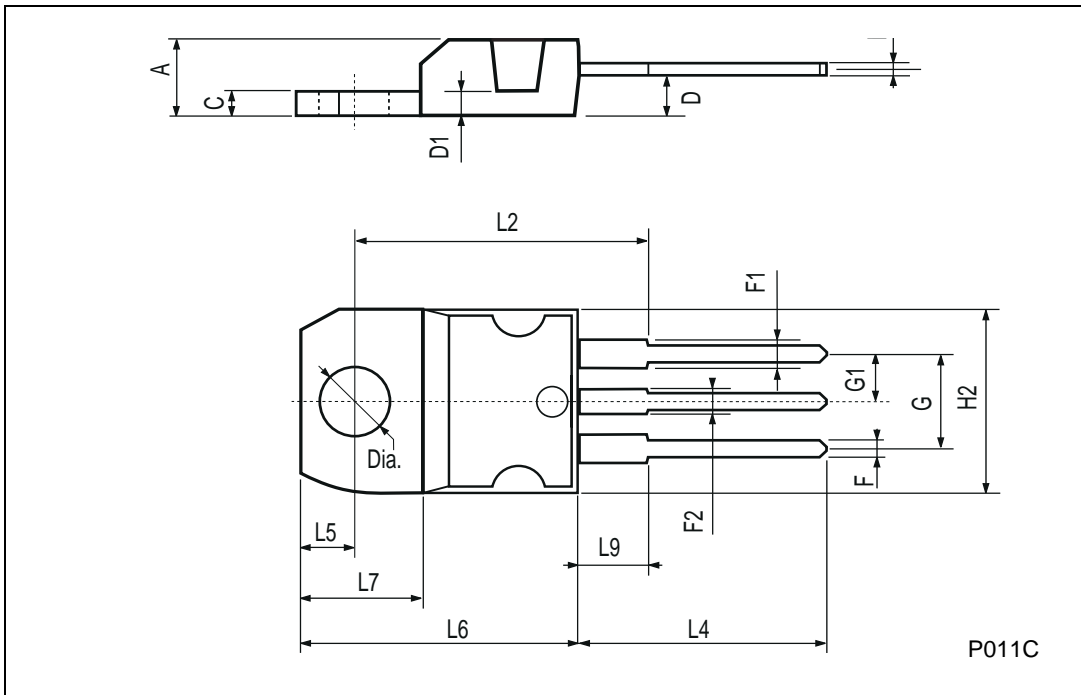

Fig. 5: Test Circuit For Inductive Load Switching And Diode Recovery Times



**TO-220 MECHANICAL DATA**

DIM.	mm			inch		
	MIN.	TYP.	MAX.	MIN.	TYP.	MAX.
A	4.40		4.60	0.173		0.181
C	1.23		1.32	0.048		0.051
D	2.40		2.72	0.094		0.107
D1		1.27			0.050	
E	0.49		0.70	0.019		0.027
F	0.61		0.88	0.024		0.034
F1	1.14		1.70	0.044		0.067
F2	1.14		1.70	0.044		0.067
G	4.95		5.15	0.194		0.203
G1	2.4		2.7	0.094		0.106
H2	10.0		10.40	0.393		0.409
L2		16.4			0.645	
L4	13.0		14.0	0.511		0.551
L5	2.65		2.95	0.104		0.116
L6	15.25		15.75	0.600		0.620
L7	6.2		6.6	0.244		0.260
L9	3.5		3.93	0.137		0.154
DIA.	3.75		3.85	0.147		0.151



TO-262 (I<sup>2</sup>PAK) MECHANICAL DATA

DIM.	mm			inch		
	MIN.	TYP.	MAX.	MIN.	TYP.	MAX.
A	4.4		4.6	0.173		0.181
A1	2.49		2.69	0.098		0.106
B	0.7		0.93	0.027		0.036
B2	1.14		1.7	0.044		0.067
C	0.45		0.6	0.017		0.023
C2	1.23		1.36	0.048		0.053
D	8.95		9.35	0.352		0.368
e	2.4		2.7	0.094		0.106
E	10		10.4	0.393		0.409
L	13.1		13.6	0.515		0.531
L1	3.48		3.78	0.137		0.149
L2	1.27		1.4	0.050		0.055

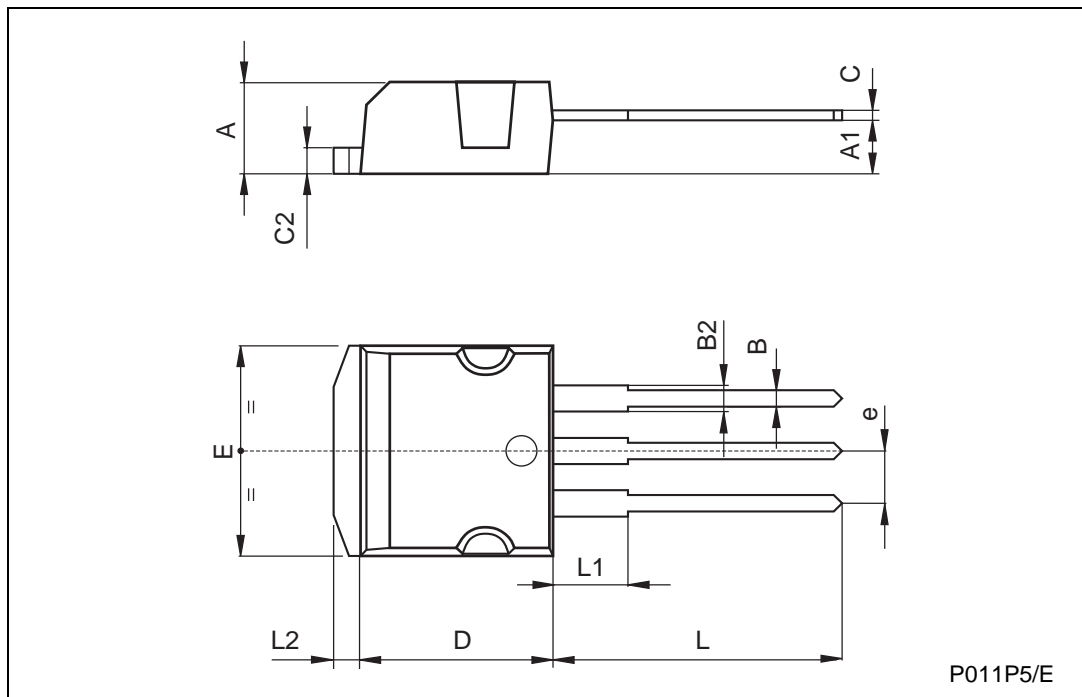



Information furnished is believed to be accurate and reliable. However, STMicroelectronics assumes no responsibility for the consequences of use of such information nor for any infringement of patents or other rights of third parties which may result from its use. No license is granted by implication or otherwise under any patent or patent rights of STMicroelectronics. Specification mentioned in this publication are subject to change without notice. This publication supersedes and replaces all information previously supplied. STMicroelectronics products are not authorized for use as critical components in life support devices or systems without express written approval of STMicroelectronics.

The ST logo is a trademark of STMicroelectronics

© 2000 STMicroelectronics – Printed in Italy – All Rights Reserved

STMicroelectronics GROUP OF COMPANIES

Australia - Brazil - China - Finland - France - Germany - Hong Kong - India - Italy - Japan - Malaysia - Malta - Morocco -  
Singapore - Spain - Sweden - Switzerland - United Kingdom - U.S.A.

<http://www.st.com>