

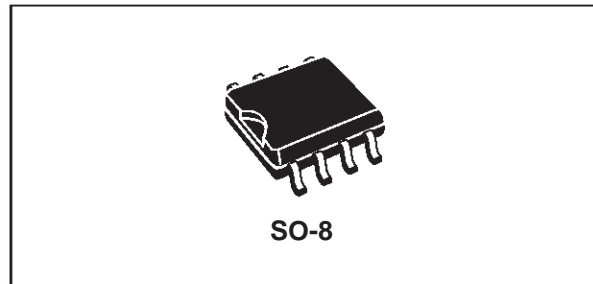

# STS8NFS30L

## STripFET™ N - CHANNEL 30V - 0.018Ω - 8A SO-8 MOSFET PLUS SCHOTTKY RECTIFIER

MAIN PRODUCT CHARACTERISTICS			
<b>MOSFET</b>	<b>V<sub>DSS</sub></b>	<b>R<sub>DS(on)</sub></b>	<b>I<sub>D</sub></b>
	30 V	<0.022 Ω	8 A
<b>SCHOTTKY</b>	<b>I<sub>F(AV)</sub></b>	<b>V<sub>RRM</sub></b>	<b>V<sub>F(MAX)</sub></b>
	3 A	30 V	0.51 V



### DESCRIPTION:

This product associates the latest low voltage StripFET™ in n-channel version to a low drop Schottky diode. Such configuration is extremely versatile in implementing, a large variety of DC-DC converters for printers, portable equipment, and cellular phones.

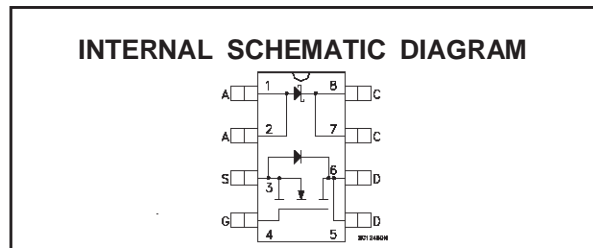

### MOSFET ABSOLUTE MAXIMUM RATINGS

Symbol	Parameter	Value	Unit
V <sub>DS</sub>	Drain-source Voltage (V <sub>GS</sub> = 0)	30	V
V <sub>DGR</sub>	Drain- gate Voltage (R <sub>GS</sub> = 20 kΩ)	30	V
V <sub>GS</sub>	Gate-source Voltage	± 20	V
I <sub>D</sub>	Drain Current (continuous) at T <sub>c</sub> = 25 °C	8	A
I <sub>D</sub>	Drain Current (continuous) at T <sub>c</sub> = 100 °C	5	A
I <sub>DM</sub> (•)	Drain Current (pulsed)	32	A
P <sub>tot</sub>	Total Dissipation at T <sub>c</sub> = 25 °C	2.5	W

### SCHOTTKY ABSOLUTE MAXIMUM RATINGS

Symbol	Parameter		Value	Unit
V <sub>RRM</sub>	Repetitive Peak Reverse Voltage		30	V
I <sub>F(RMS)</sub>	RMS Forward Current		20	A
I <sub>F(AV)</sub>	Average Forward Current	T <sub>L</sub> =125 °C δ=0.5	3	A
I <sub>FSM</sub>	Surge Non Repetitive Forward Current	tp= 10 ms Sinusoidal	75	A
I <sub>RSM</sub>	Non Repetitive Peak Reverse Current	tp=100 μs	1	A
dv/dt	Critical Rate Of Rise Of Reverse Voltage		10000	V/μs

(•) Pulse width limited by safe operating area

## STS8NFS30L

### THERMAL DATA

R <sub>thj-amb</sub>	(*) Thermal Resistance Junction-ambient MOSFET	50	°C/W
R <sub>thj-amb</sub>	(*) Thermal Resistance Junction-ambient SCHOTTKY	100	°C/W
T <sub>stg</sub>	Storage Temperature Range	-65 to 150	°C
T <sub>j</sub>	Junction Temperature	150	°C
	(*) mounted on FR-4 board (steady state)		

### MOSFET ELECTRICAL CHARACTERISTICS (T<sub>case</sub> = 25 °C unless otherwise specified)

#### OFF

Symbol	Parameter	Test Conditions	Min.	Typ.	Max.	Unit
V <sub>(BR)DSS</sub>	Drain-source Breakdown Voltage	I <sub>D</sub> = 250 μA V <sub>GS</sub> = 0	30			V
I <sub>DSS</sub>	Zero Gate Voltage Drain Current (V <sub>GS</sub> = 0)	V <sub>DS</sub> = Max Rating V <sub>DS</sub> = Max Rating T <sub>c</sub> = 125 °C			1 10	μA μA
I <sub>GSS</sub>	Gate-body Leakage Current (V <sub>DS</sub> = 0)	V <sub>GS</sub> = ± 20 V			± 100	nA

#### ON (\*)

Symbol	Parameter	Test Conditions	Min.	Typ.	Max.	Unit
V <sub>GS(th)</sub>	Gate Threshold Voltage	V <sub>DS</sub> = V <sub>GS</sub> I <sub>D</sub> = 250 μA	1	1.6	2.5	V
R <sub>DS(on)</sub>	Static Drain-source On Resistance	V <sub>GS</sub> = 10V I <sub>D</sub> = 4 A V <sub>GS</sub> = 4.5V I <sub>D</sub> = 4 A		0.018 0.021	0.022 0.026	Ω Ω
I <sub>D(on)</sub>	On State Drain Current	V <sub>DS</sub> > I <sub>D(on)</sub> × R <sub>DS(on)max</sub> V <sub>GS</sub> = 10 V	8			A

#### DYNAMIC

Symbol	Parameter	Test Conditions	Min.	Typ.	Max.	Unit
g <sub>fs</sub> (*)	Forward Transconductance	V <sub>DS</sub> > I <sub>D(on)</sub> × R <sub>DS(on)max</sub> I <sub>D</sub> = 4 A		10		S
C <sub>iss</sub>	Input Capacitance	V <sub>DS</sub> = 25 V f = 1 MHz V <sub>GS</sub> = 0		1050		pF
C <sub>oss</sub>	Output Capacitance			250		pF
C <sub>rss</sub>	Reverse Transfer Capacitance			85		pF

**ELECTRICAL CHARACTERISTICS** (continued)

**SWITCHING ON**

Symbol	Parameter	Test Conditions	Min.	Typ.	Max.	Unit
$t_{d(on)}$	Turn-on Delay Time	$V_{DD} = 15\text{ V}$ $I_D = 4\text{ A}$ $R_G = 4.7\ \Omega$ $V_{GS} = 4.5\text{ V}$ (Resistive Load, see fig. 3)		22		ns
$t_r$	Rise Time			60		ns
$Q_g$	Total Gate Charge	$V_{DD} = 24\text{ V}$ $I_D = 8\text{ A}$ $V_{GS} = 4.5\text{ V}$		17.5	23	nC
$Q_{gs}$	Gate-Source Charge			4		nC
$Q_{gd}$	Gate-Drain Charge			7		nC

**SWITCHING OFF**

Symbol	Parameter	Test Conditions	Min.	Typ.	Max.	Unit
$t_{d(off)}$	Turn-off Delay Time	$V_{DD} = 15\text{ V}$ $I_D = 4\text{ A}$ $R_G = 4.7\ \Omega$ $V_{GS} = 4.5\text{ V}$ (Resistive Load, see fig. 3)		42		ns
$t_f$	Fall Time			10		ns
$t_{r(voff)}$	Off-voltage Rise Time	$V_{DD} = 24\text{ V}$ $I_D = 8\text{ A}$ $R_G = 4.7\ \Omega$ $V_{GS} = 4.5\text{ V}$ (Inductive Load, see fig. 5)		11		ns
$t_f$	Fall Time			12		ns
$t_c$	Cross-over Time			25		ns

**SOURCE DRAIN DIODE**

Symbol	Parameter	Test Conditions	Min.	Typ.	Max.	Unit
$I_{SD}$	Source-drain Current				8	A
$I_{SDM}(\bullet)$	Source-drain Current (pulsed)				32	A
$V_{SD}(\ast)$	Forward On Voltage	$I_{SD} = 8\text{ A}$ $V_{GS} = 0$			2	V
$t_{rr}$	Reverse Recovery Time	$I_{SD} = 8\text{ A}$ $di/dt = 100\text{ A}/\mu\text{s}$ $V_{DD} = 20\text{ V}$ $T_j = 150\text{ }^\circ\text{C}$ (see test circuit, figure 5)		50		ns
$Q_{rr}$	Reverse Recovery Charge			40		nC
$I_{RRM}$	Reverse Recovery Current			1.6		A

(\*) Pulsed: Pulse duration = 300  $\mu\text{s}$ , duty cycle 1.5 %

(•) Pulse width limited by safe operating area

**SCHOTTCKY STATIC ELECTRICAL CHARACTERISTICS**

Symbol	Parameter	Test Conditions	Min.	Typ.	Max.	Unit
$I_R(\ast)$	Reversed Leakage Current	$T_J = 25\text{ }^\circ\text{C}$ $V_R = 30\text{ V}$ $T_J = 125\text{ }^\circ\text{C}$ $V_R = 30\text{ V}$		0.03	0.2	mA mA
$V_F(\ast)$	Forward Voltage drop	$T_J = 25\text{ }^\circ\text{C}$ $I_F = 3\text{ A}$ $T_J = 125\text{ }^\circ\text{C}$ $I_F = 3\text{ A}$		0.38	0.51 0.46	V V

Safe Operating Area

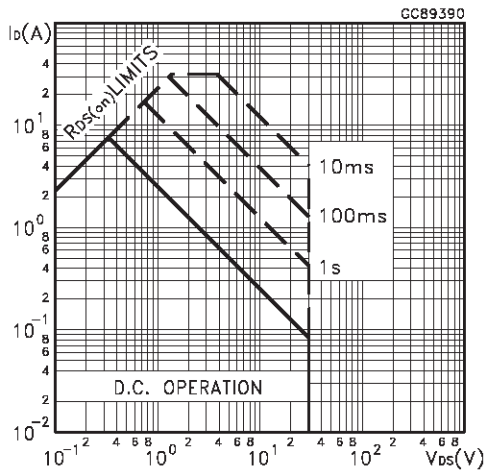

Thermal Impedance

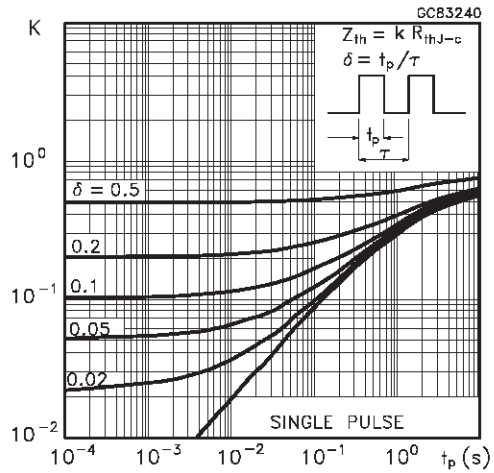

Output Characteristics

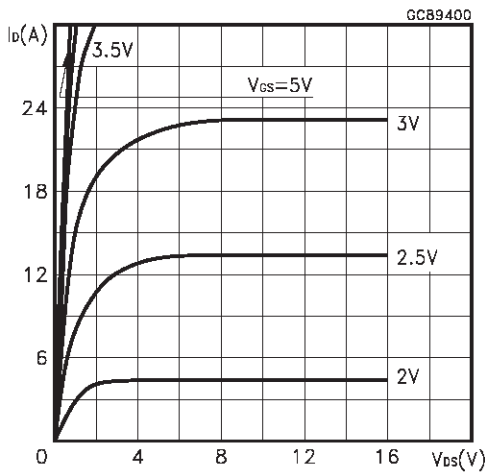

Transfer Characteristics

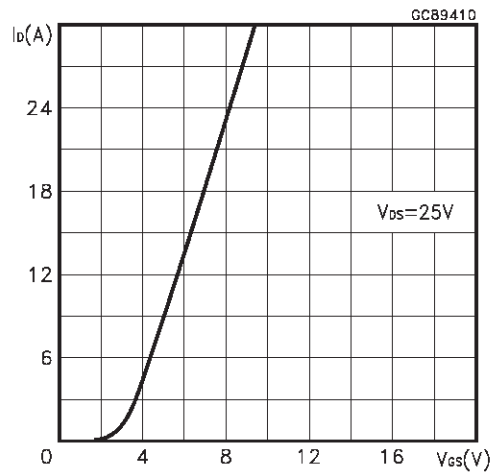

Transconductance

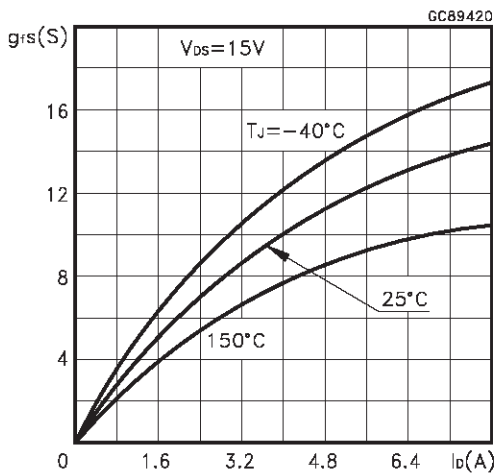

Static Drain-source On Resistance

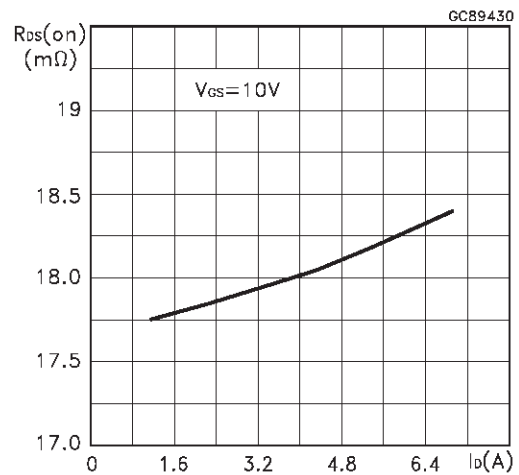

Gate Charge vs Gate-source Voltage

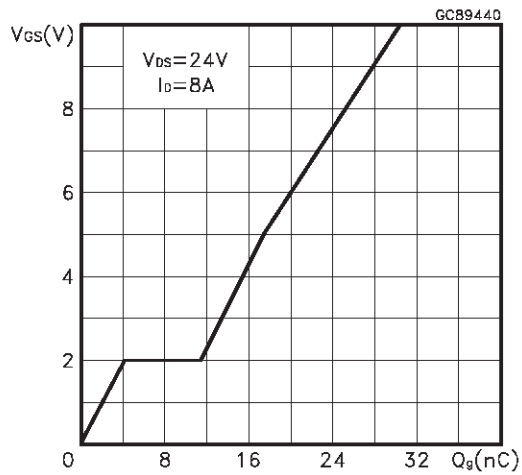

Capacitance Variations

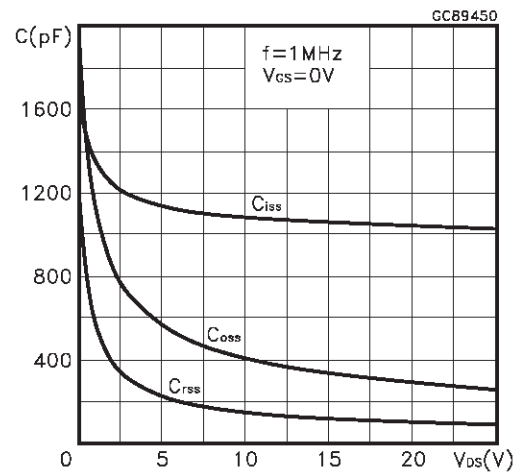

Normalized Gate Threshold Voltage vs Temperature

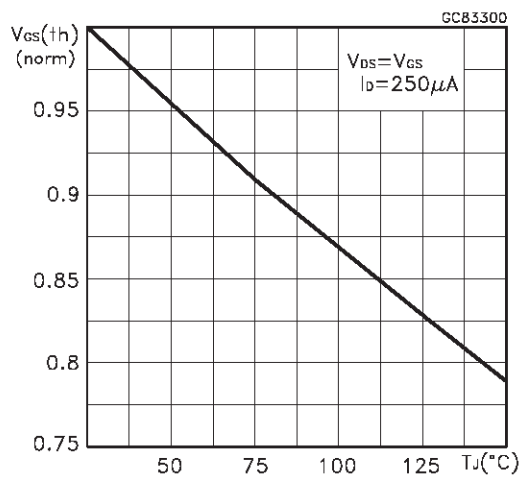

Normalized On Resistance vs Temperature

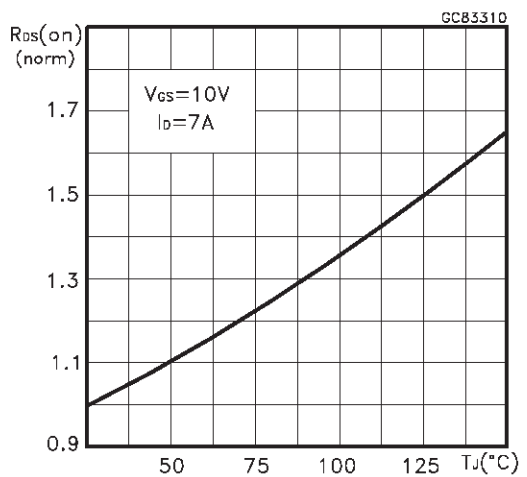

Source-drain Diode Forward Characteristics

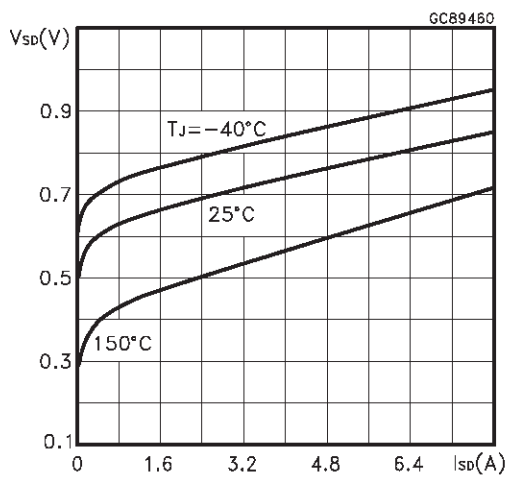

Fig. 1: Unclamped Inductive Load Test Circuit



Fig. 2: Unclamped Inductive Waveform



Fig. 3: Switching Times Test Circuits For Resistive Load



Fig. 4: Gate Charge test Circuit

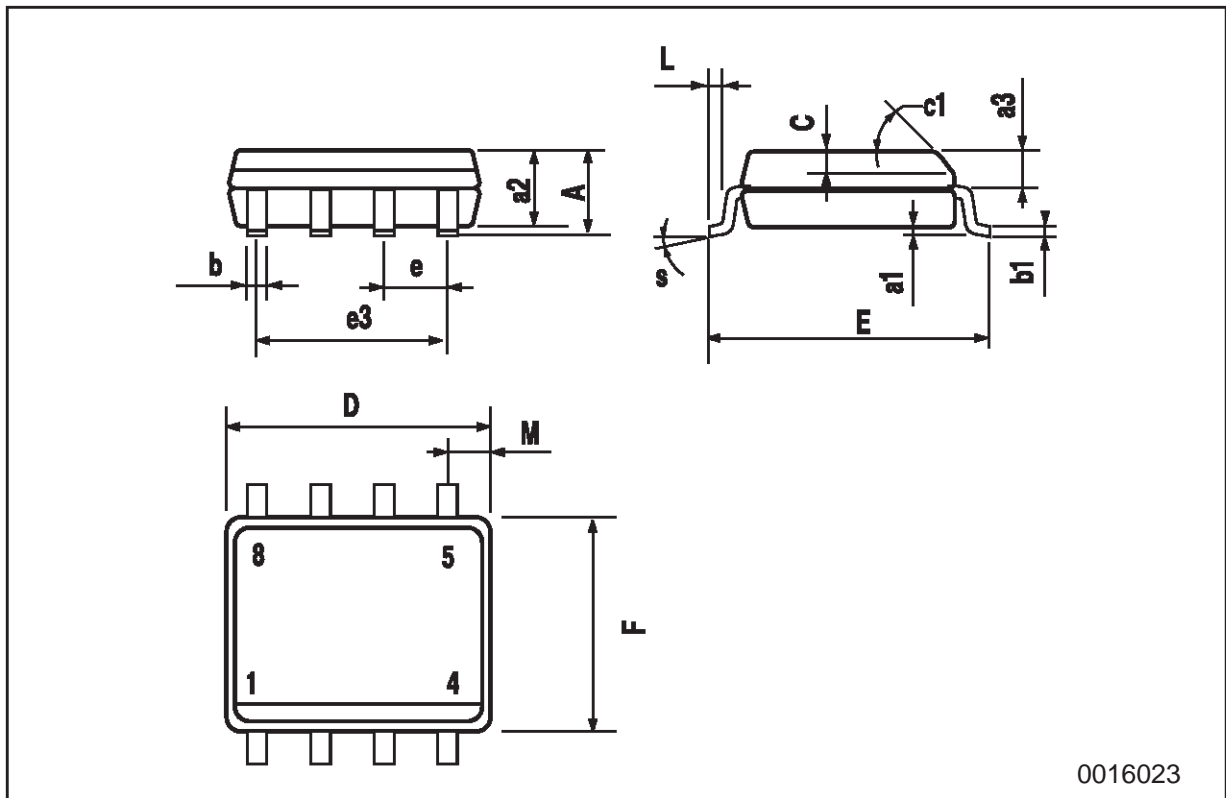

Fig. 5: Test Circuit For Inductive Load Switching And Diode Recovery Times



**SO-8 MECHANICAL DATA**

DIM.	mm			inch		
	MIN.	TYP.	MAX.	MIN.	TYP.	MAX.
A			1.75			0.068
a1	0.1		0.25	0.003		0.009
a2			1.65			0.064
a3	0.65		0.85	0.025		0.033
b	0.35		0.48	0.013		0.018
b1	0.19		0.25	0.007		0.010
C	0.25		0.5	0.010		0.019
c1	45 (typ.)					
D	4.8		5.0	0.188		0.196
E	5.8		6.2	0.228		0.244
e		1.27			0.050	
e3		3.81			0.150	
F	3.8		4.0	0.14		0.157
L	0.4		1.27	0.015		0.050
M			0.6			0.023
S	8 (max.)					



0016023

Information furnished is believed to be accurate and reliable. However, STMicroelectronics assumes no responsibility for the consequences of use of such information nor for any infringement of patents or other rights of third parties which may result from its use. No license is granted by implication or otherwise under any patent or patent rights of STMicroelectronics. Specification mentioned in this publication are subject to change without notice. This publication supersedes and replaces all information previously supplied. STMicroelectronics products are not authorized for use as critical components in life support devices or systems without express written approval of STMicroelectronics.

The ST logo is a trademark of STMicroelectronics

© 1999 STMicroelectronics – Printed in Italy – All Rights Reserved  
STMicroelectronics GROUP OF COMPANIES

Australia - Brazil - China - Finland - France - Germany - Hong Kong - India - Italy - Japan - Malaysia - Malta - Morocco -  
Singapore - Spain - Sweden - Switzerland - United Kingdom - U.S.A.