



# STTA512D/F/B/FP

## TURBOSWITCH ULTRA-FAST HIGH VOLTAGE DIODE

### MAIN PRODUCT CHARACTERISTICS

$I_{F(AV)}$	5A
$V_{RRM}$	1200V
$t_{rr} (typ)$	45ns
$V_F (max)$	2.0V

### FEATURES AND BENEFITS

- SPECIFIC TO THE FOLLOWING OPERATIONS: SNUBBING OR CLAMPING, DEMAGNETIZATION AND RECTIFICATION
- ULTRA-FAST, SOFT RECOVERY.
- VERY LOW OVERALL POWER LOSSES IN BOTH THE DIODE AND THE COMPANION TRANSISTOR.
- HIGH FREQUENCY AND/OR HIGH PULSED CURRENT OPERATION.
- HIGH REVERSE VOLTAGE CAPABILITY
- INSULATED PACKAGES: ISOWATT220AC, TO-220FPAC
- Electrical insulation : 2000V DC  
Capacitance : 12pF.

### DESCRIPTION

TURBOSWITCH 1200V drastically cuts losses in all high voltage operations which require extremely fast, soft and noise-free power diodes. Due to their optimized switching performances they also highly decrease power losses in any associated switching IGBT or MOSFET in all "freewheel mode" operations.

### ABSOLUTE RATINGS (limiting values)

Symbol	Parameter	Value	Unit	
$V_{RRM}$	Repetitive peak reverse voltage	1200	V	
$V_{RSM}$	Non repetitive peak reverse voltage	1200	V	
$I_{F(RMS)}$	RMS forward current	TO-220AC / DPAK	20	A
		ISOWATT220AC / TO-220FPAC	10	A
$I_{FRM}$	Repetitive peak forward current	$t_p = 5 \mu s$ F = 5kHz square	70	A
$I_{FSM}$	Surge non repetitive forward current	$t_p = 10ms$ sinusoidal	45	A
$T_{stg}$	Storage temperature range	- 65 to + 150	°C	
$T_j$	Maximum operating junction temperature	150	°C	

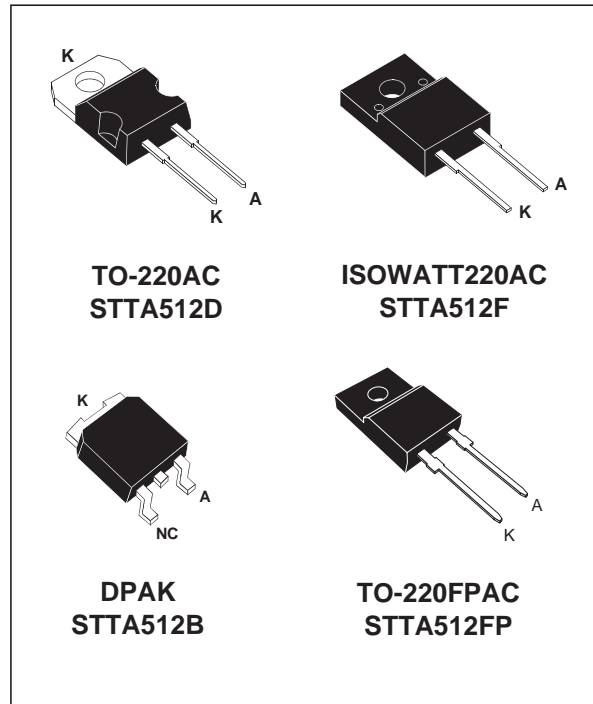

They are particularly suitable in motor control circuitries, or in the primary of SMPS as snubber, clamping or demagnetizing diodes. They are also suitable for secondary of SMPS as high voltage rectifier diodes.

**THERMAL AND POWER DATA**

Symbol	Parameter	Conditions	Value	Unit
R <sub>th(j-c)</sub>	Junction to case thermal resistance	TO-220AC / DPAK	4.0	°C/W
		ISOWATT220AC / TO-220FPAC	5.5	
P <sub>1</sub>	Conduction power dissipation I <sub>F(AV)</sub> = 5A δ = 0.5	TO-220AC / DPAK T <sub>c</sub> = 102°C	12	W
		ISOWATT220AC / TO-220FPAC T <sub>c</sub> = 84°C		
P <sub>max</sub>	Total power dissipation P <sub>max</sub> = P <sub>1</sub> + P <sub>3</sub> (P <sub>3</sub> = 10% P <sub>1</sub> )	TO-220AC / DPAK T <sub>c</sub> = 98°C	13	W
		ISOWATT220AC / TO-220FPAC T <sub>c</sub> = 78°C		

**STATIC ELECTRICAL CHARACTERISTICS**

Symbol	Parameter	Test conditions	Min	Typ	Max	Unit
V <sub>F</sub> *	Forward voltage drop	I <sub>F</sub> = 5A T <sub>j</sub> = 25°C T <sub>j</sub> = 125°C			2.2	V
				1.35	2.0	V
I <sub>R</sub> **	Reverse leakage current	V <sub>R</sub> = 0.8 x V <sub>RRM</sub> T <sub>j</sub> = 25°C T <sub>j</sub> = 125°C		0.3	100	μA
					2.0	mA
V <sub>t0</sub>	Threshold voltage	I <sub>p</sub> < 3.I <sub>AV</sub> T <sub>j</sub> = 125°C			1.57	V
R <sub>d</sub>	Dynamic resistance				86	mΩ

Pulse test: \* t<sub>p</sub> = 380 μs, δ < 2%  
 \*\* t<sub>p</sub> = 5 ms, δ < 2%

To evaluate the maximum conduction losses use the following equation :  
 $P = V_{to} \times I_{F(AV)} + r_d \times I_{F(RMS)}^2$

**DYNAMIC ELECTRICAL CHARACTERISTICS**

**TURN-OFF SWITCHING**

Symbol	Parameter	Test conditions	Min	Typ	Max	Unit
t <sub>rr</sub>	Reverse recovery time	T <sub>j</sub> = 25°C I <sub>F</sub> = 0.5 A I <sub>R</sub> = 1A I <sub>rr</sub> = 0.25A I <sub>F</sub> = 1 A dI <sub>F</sub> /dt = -50A/μs V <sub>R</sub> = 30V		45	95	ns
I <sub>RM</sub>	Maximum reverse recovery current	T <sub>j</sub> = 125°C V <sub>R</sub> = 600V I <sub>F</sub> = 5A dI <sub>F</sub> /dt = -40 A/μs dI <sub>F</sub> /dt = -500 A/μs		20	7.5	A
S <sub>factor</sub>	Softness factor	T <sub>j</sub> = 125°C V <sub>R</sub> = 600V I <sub>F</sub> = 5A dI <sub>F</sub> /dt = -500 A/μs		1.2		/

**TURN-ON SWITCHING**

Symbol	Parameter	Test conditions	Min	Typ	Max	Unit
t <sub>fr</sub>	Forward recovery time	T <sub>j</sub> = 25°C I <sub>F</sub> = 5 A, dI <sub>F</sub> /dt = 40 A/μs measured at 1.1 x V <sub>Fmax</sub>			900	ns
V <sub>Fp</sub>	Peak forward voltage	T <sub>j</sub> = 25°C I <sub>F</sub> = 5A, dI <sub>F</sub> /dt = 40 A/μs I <sub>F</sub> = 40A, dI <sub>F</sub> /dt = 500 A/μs		50	35	V

**Fig. 1:** Conduction losses versus average current.

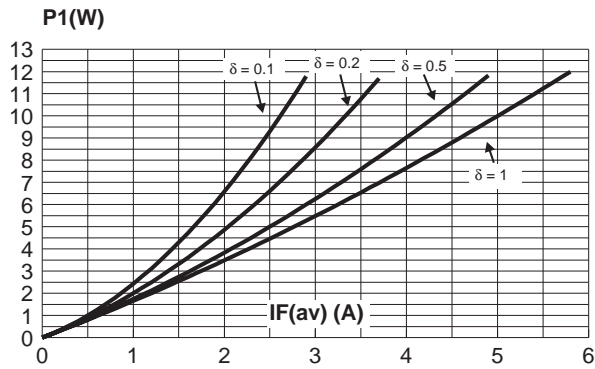

**Fig. 2:** Forward voltage drop versus forward current (maximum values).

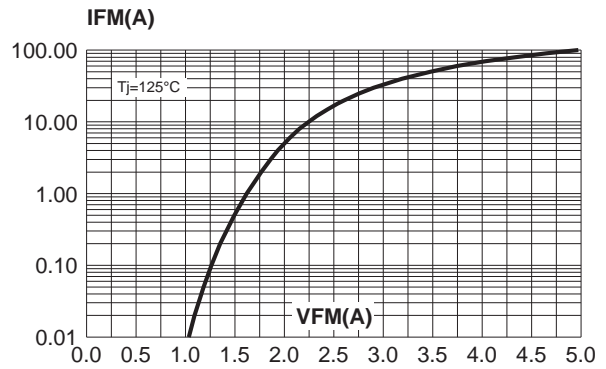

**Fig. 3:** Peak reverse recovery current versus  $dI_F/dt$  (90% confidence).

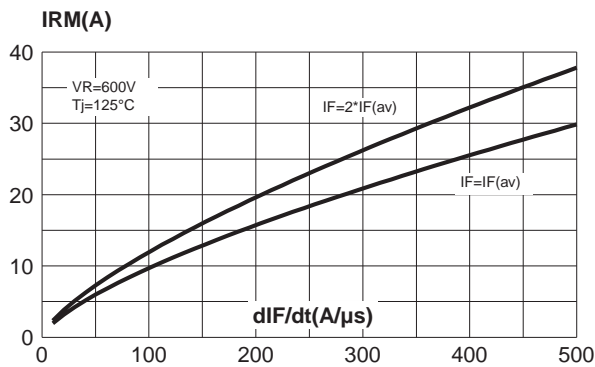

**Fig. 4:** Relative variation of thermal impedance junction to case versus pulse duration (TO-220AC and DPAK).

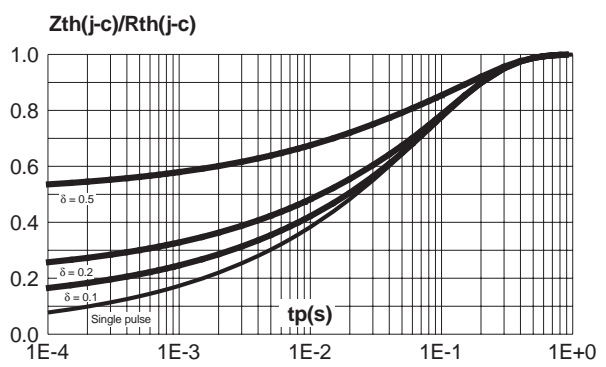

**Fig. 5:** Relative variation of thermal impedance junction to case versus pulse duration (ISOWATT220AC and TO-220FPAC).

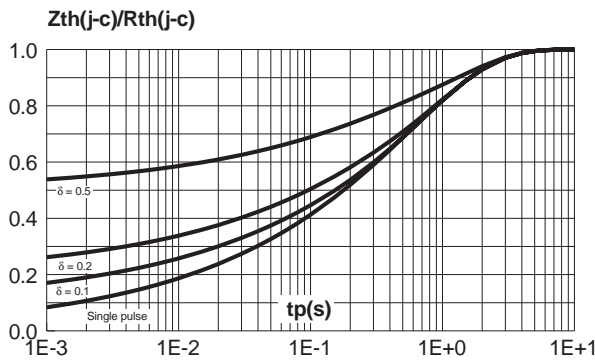

**Fig. 6:** Reverse recovery time versus  $dI_F/dt$  (90% confidence).

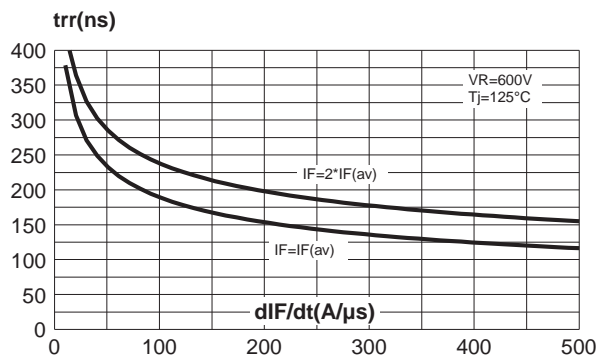

**Fig. 7:** Softness factor ( $t_b/t_a$ ) versus  $dI_F/dt$  (typical values).

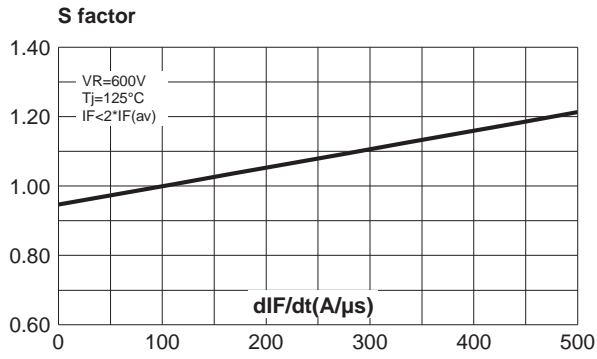

**Fig. 8:** Relative variation of dynamic parameters versus junction temperature (reference Tj=125°C).

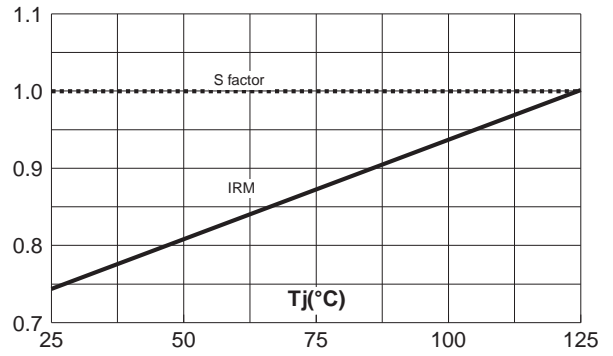

**Fig. 9:** Transient peak forward voltage versus  $dI_F/dt$  (90% confidence).

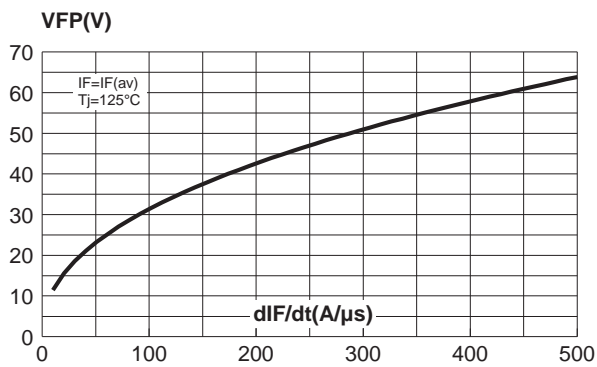

**Fig. 10:** Forward recovery time versus  $dI_F/dt$  (90% confidence).

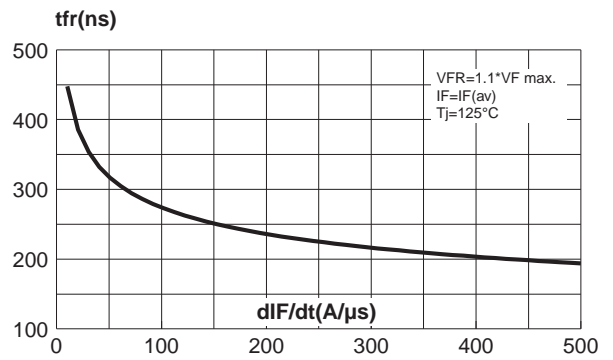

## APPLICATION DATA

The 1200V TURBOSWITCH series has been designed to provide the lowest overall power losses in all high frequency or high pulsed current operations. In such applications (Fig A to D), the way of calculating the power losses is given below :

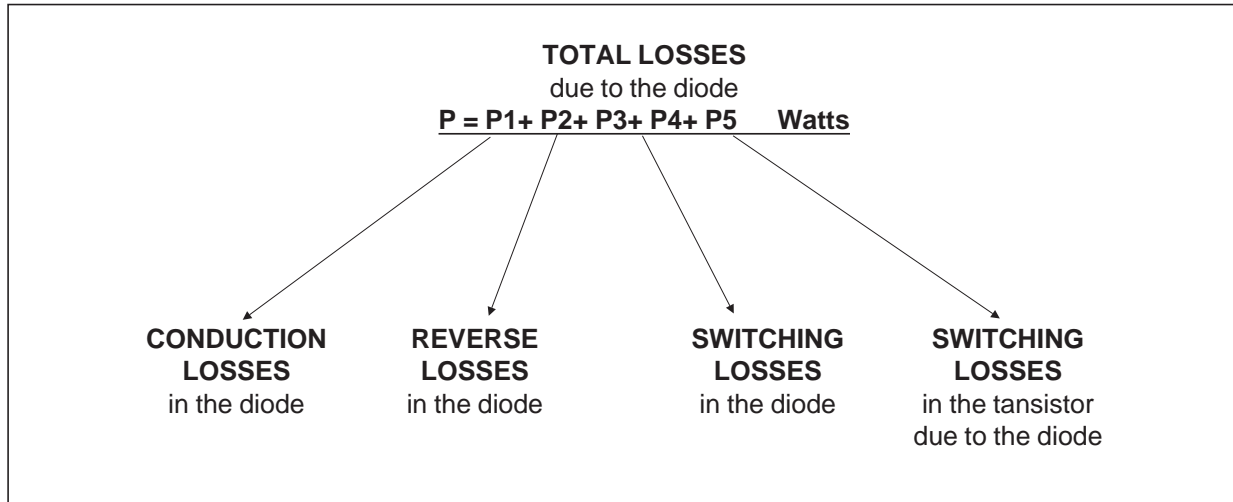

Fig. A : "FREEWHEEL" MODE.

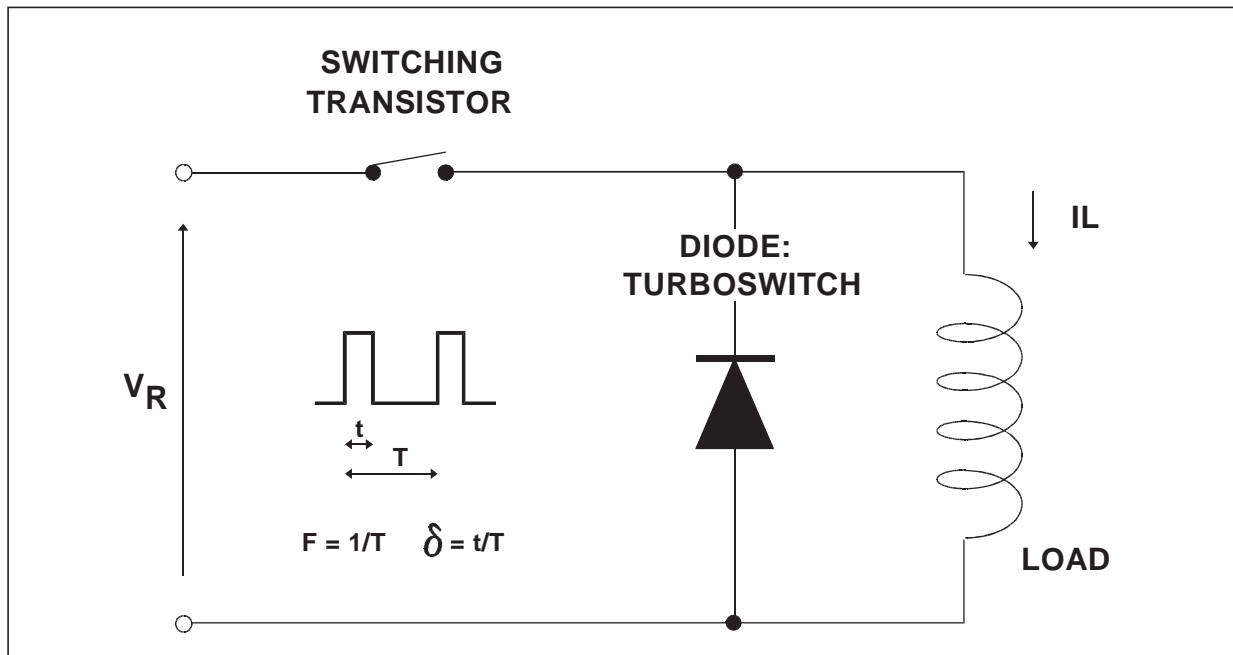

Fig. B : SNUBBER DIODE.

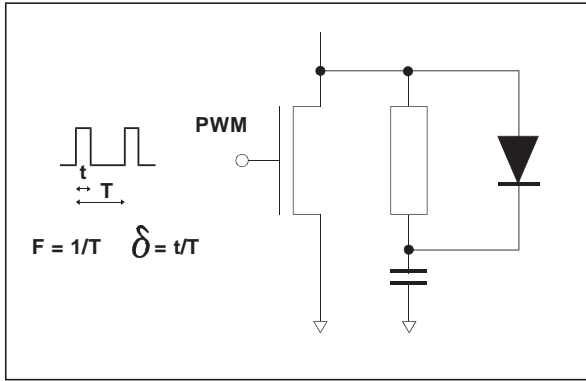

Fig. C : DEMAGNETIZING DIODE.

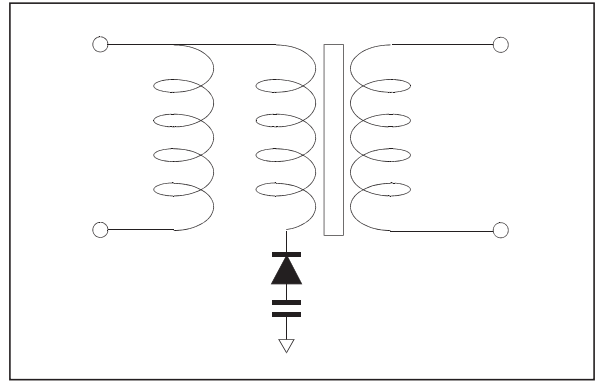
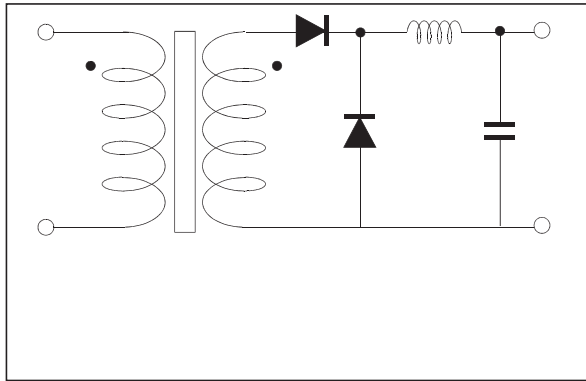
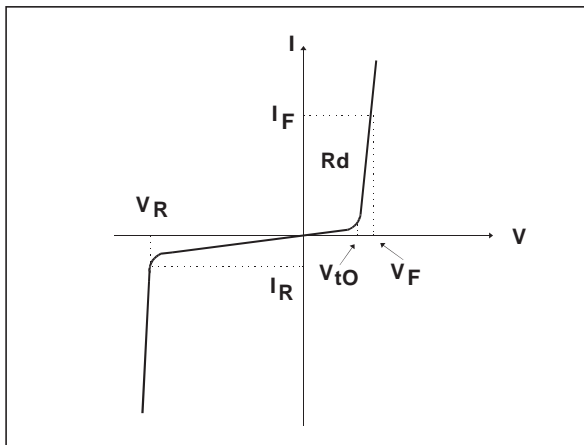

Fig. D : RECTIFIER DIODE.



**STATIC & DYNAMIC CHARACTERISTICS . POWER LOSSES .**

Fig. E: STATIC CHARACTERISTICS



**Conduction losses :**

$$P1 = V_{t0} \cdot I_{F(AV)} + R_d \cdot I_{F(RMS)}^2$$

**Reverse losses :**

$$P2 = V_R \cdot I_R \cdot (1 - \delta)$$

APPLICATION DATA (Cont'd)

Fig. F: TURN-OFF CHARACTERISTICS

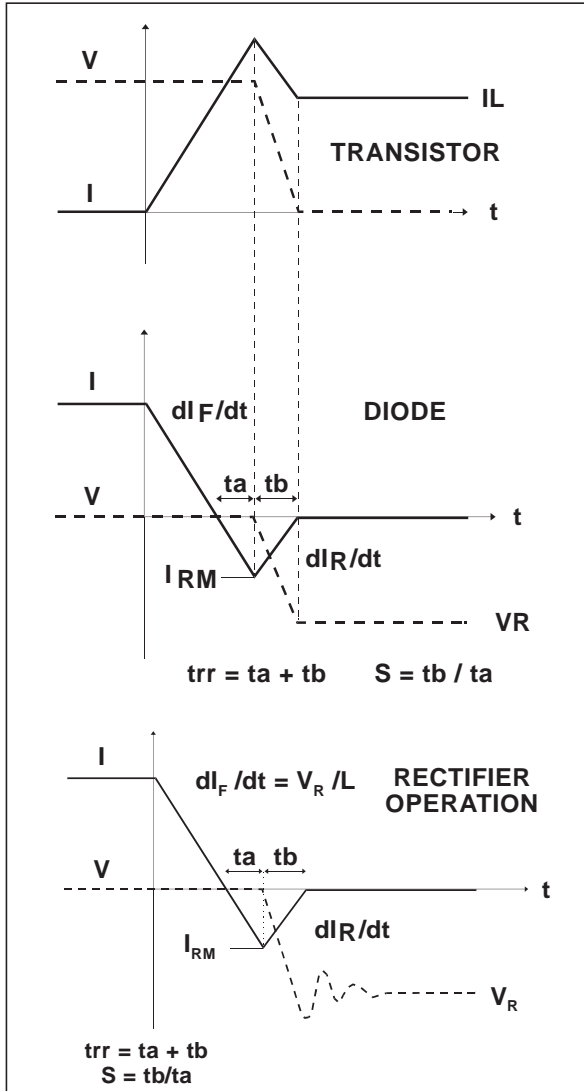

Turn-on losses :  
(in the transistor, due to the diode)

$$P5 = \frac{V_R \times I_{RM}^2 \times (3 + 2 \times S) \times F}{6 \times dI_F / dt} + \frac{V_R \times I_{RM} \times I_L \times (S + 2) \times F}{2 \times dI_F / dt}$$

Turn-off losses (in the diode) :

$$P3 = \frac{V_R \times I_{RM}^2 \times S \times F}{6 \times dI_F / dt}$$

Turn-off losses :  
(with non negligible serial inductance)

$$P3' = \frac{V_R \times I_{RM}^2 \times S \times F}{6 \times dI_F / dt} + \frac{L \times I_{RM}^2 \times F}{2}$$

P3,P3' and P5 are suitable for power MOSFET and IGBT

Fig. G: TURN-ON CHARACTERISTICS

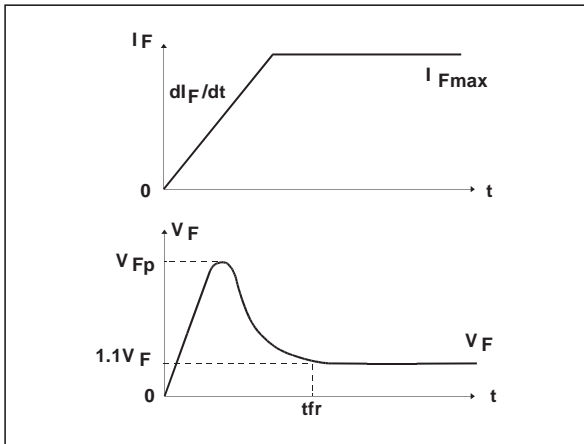

Turn-on losses :  
 $P4 = 0.4 (V_{FP} - V_F) \cdot I_{Fmax} \cdot t_{fr} \cdot F$

**STTA512D/F/B/FP**

**PACKAGE DATA**  
DPAK

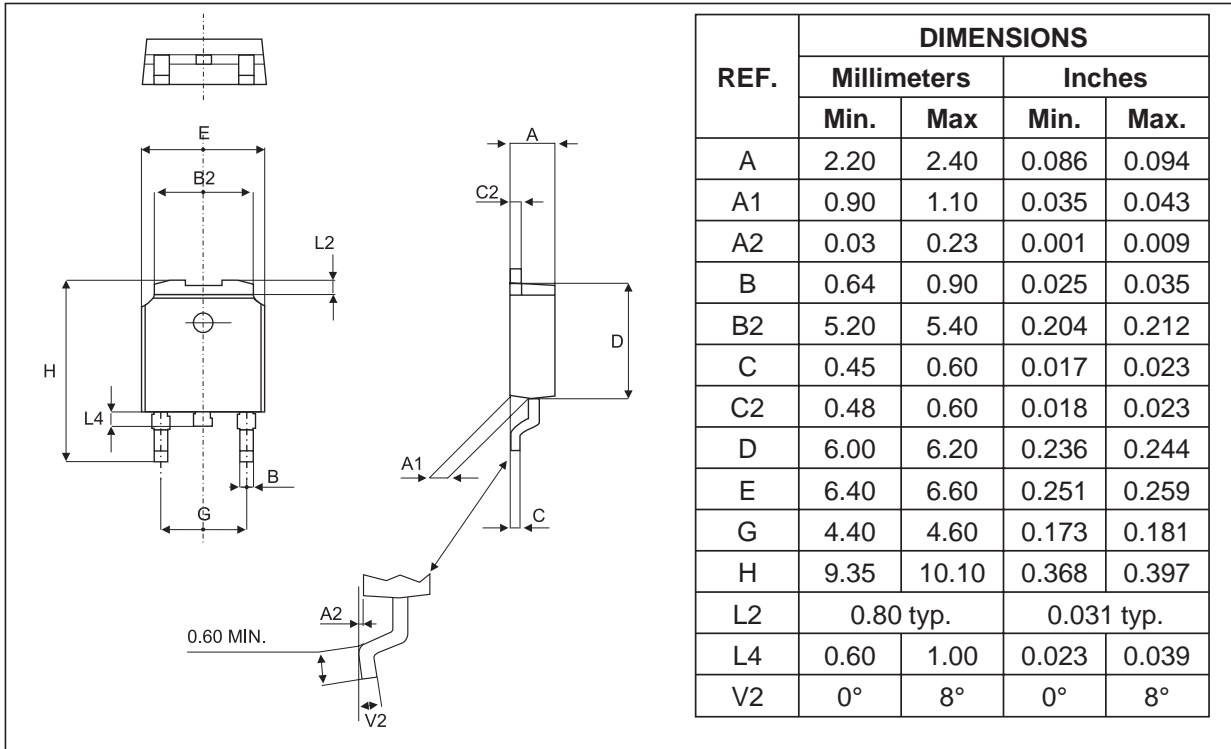

**FOOTPRINT DIMENSIONS (in millimeters)**

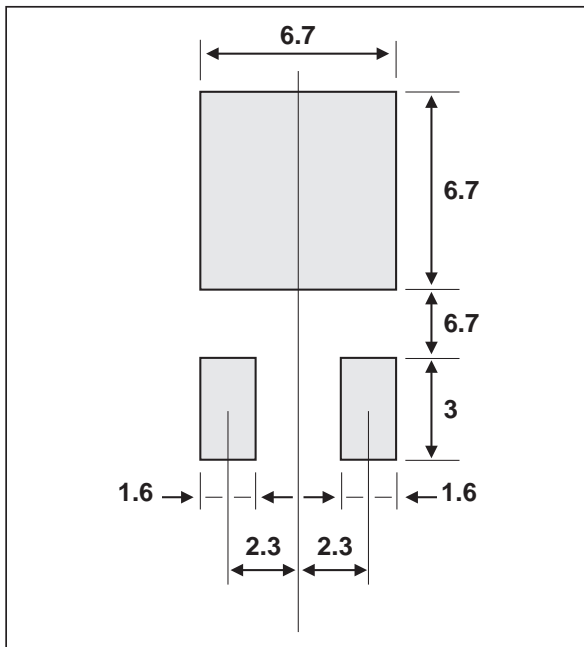



**PACKAGE DATA**  
ISOWATT220AC

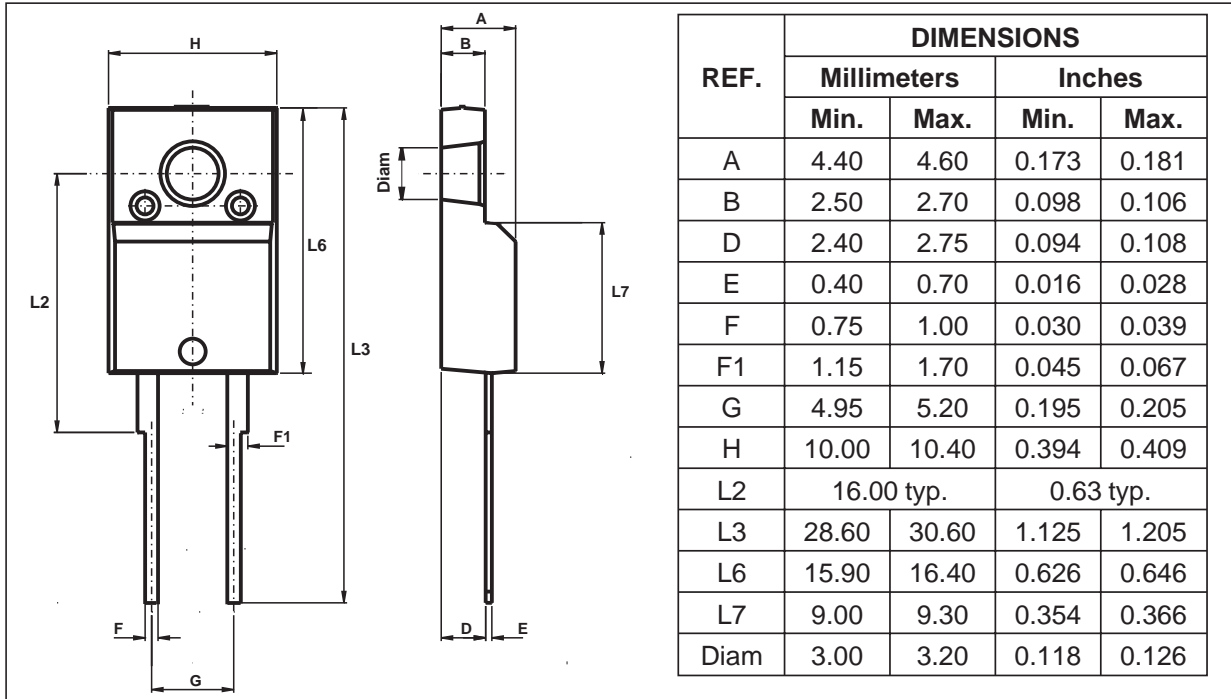

- Cooling method: by conduction (C)
- Recommended torque value: 0.55 m.N
- Maximum torque value: 0.7 m.N

**PACKAGE DATA**  
TO-220FPAC

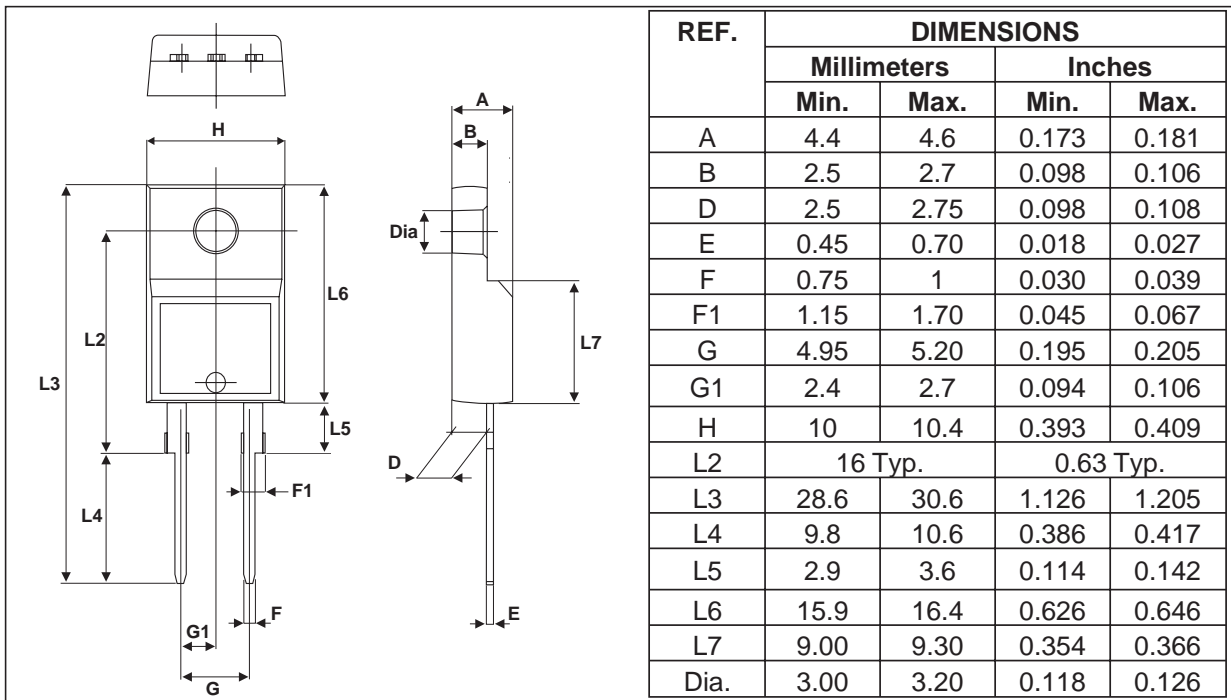

# STTA512D/F/B/FP

## PACKAGE DATA

TO-220AC (JEDEC outline)

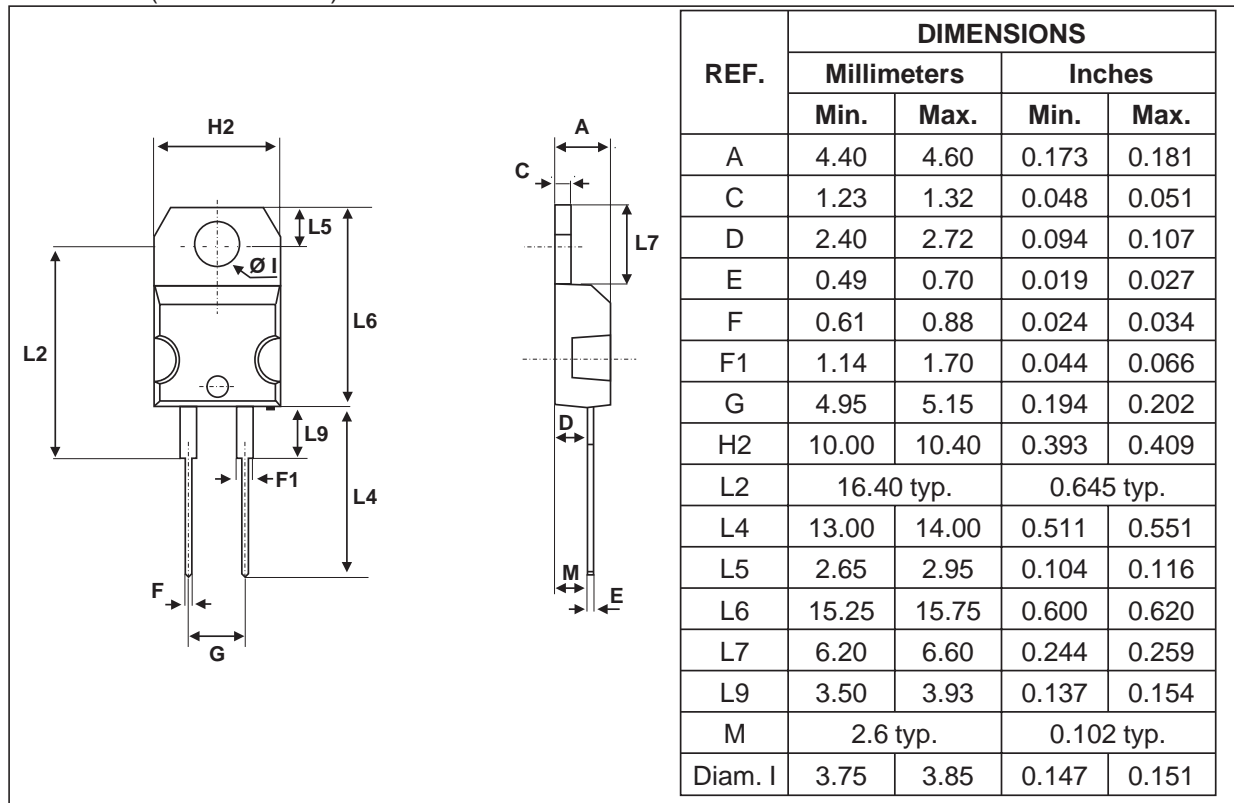

- Cooling method: by conduction (C)
- Recommended torque value: 0.55 m.N
- Maximum torque value: 0.7 m.N

Ordering type	Marking	Package	Weight	Base qty	Delivery mode
STTA512D	STTA512D	TO-220AC	1.86g	50	Tube
STTA512F	STTA512F	ISOWATT220AC	2g	50	Tube
STTA512B	A512	DPAK	0.3g	75	Tube
STTA512B-TR	A512	DPAK	0.3g	2500	Tape & reel
STTA512FP	STTA512FP	TO-220FPAC	2g	50	Tube

- Epoxy meets UL94,V0

Information furnished is believed to be accurate and reliable. However, STMicroelectronics assumes no responsibility for the consequences of use of such information nor for any infringement of patents or other rights of third parties which may result from its use. No license is granted by implication or otherwise under any patent or patent rights of STMicroelectronics. Specifications mentioned in this publication are subject to change without notice. This publication supersedes and replaces all information previously supplied. STMicroelectronics products are not authorized for use as critical components in life support devices or systems without express written approval of STMicroelectronics.

The ST logo is a registered trademark of STMicroelectronics  
 © 2003 STMicroelectronics - Printed in Italy - All rights reserved.  
 STMicroelectronics GROUP OF COMPANIES  
 Australia - Brazil - Canada - China - Finland - France - Germany  
 Hong Kong - India - Israel - Italy - Japan - Malaysia - Malta - Morocco - Singapore  
 Spain - Sweden - Switzerland - United Kingdom - United States.

<http://www.st.com>

