

Ultrafast recovery diode

Datasheet - production data

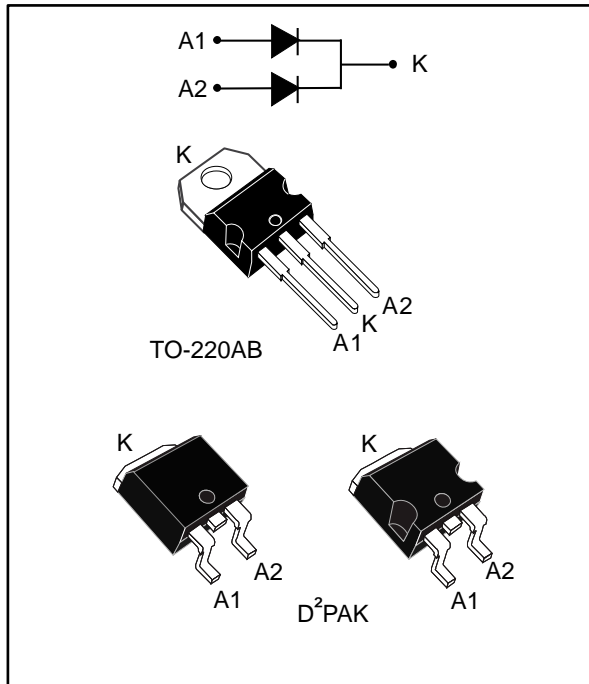

Description

This series uses ST's new 400 V planar Pt doping technology. This device is specially suited for switching mode base drive and transistor circuits.

Packaged in through-the-hole and surface mount packages, this device is intended for use in low voltage, high frequency inverters, freewheeling and polarity protection.

Table 1: Device summary

Symbol	Value
$I_{F(AV)}$	2 x 8 A
V_{RRM}	400 V
T_j (max)	175 °C
V_F (typ)	0.9 V
t_{rr} (typ)	25 ns

Features

- Very low switching losses
- High frequency and/or high pulsed current operation
- High junction temperature
- ECOPACK®2 compliant component for D²PAK on demand

1 Characteristics

Table 2: Absolute ratings (limiting values, per diode, at 25 °C, unless otherwise specified)

Symbol	Parameter			Value	Unit
V _{RRM}	Repetitive peak reverse voltage			400	V
I _{F(RMS)}	Forward rms current			30	A
I _{F(AV)}	Average forward current δ = 0.5, square wave	T _C = 150 °C	Per diode	8	A
		T _C = 145 °C	Per device	16	
I _{FSM}	Surge non repetitive forward current	t _p = 10 ms sinusoidal		120	A
T _{stg}	Storage temperature range			-65 to +175	°C
T _j	Maximum operating junction temperature range			-40 to +175	°C

Table 3: Thermal parameter

Symbol	Parameter		Max. value	Unit
R _{th(j-c)}	Junction to case	Per diode	2	°C/W
		Per device	1.15	
R _{th(c)}	Coupling		0.3	°C/W

When the diodes 1 and 2 are used simultaneously:

$$\Delta T_{j(\text{diode}1)} = P_{(\text{diode}1)} \times R_{th(j-c)} \text{ (per diode)} + P_{(\text{diode}2)} \times R_{th(c)}$$

Table 4: Static electrical characteristics (per diode)

Symbol	Parameter	Test conditions		Min.	Typ.	Max.	Unit
I _R ⁽¹⁾	Reverse leakage current	T _j = 25 °C	V _R = V _{RRM}	-		10	µA
		T _j = 125 °C		-	10	100	
V _F ⁽²⁾	Forward voltage drop	T _j = 25 °C	I _F = 8 A	-		1.5	V
		T _j = 100 °C		-	1.05	1.3	
		T _j = 150 °C		-	0.9	1.1	
		T _j = 25 °C	I _F = 16 A	-		1.75	
		T _j = 100 °C		-	1.25	1.55	
		T _j = 150 °C		-	1.12	1.37	

Notes:

⁽¹⁾Pulse test: t_p = 5 ms, δ < 2%

⁽²⁾Pulse test: t_p = 380 µs, δ < 2%

To evaluate the conduction losses, use the following equation:

$$P = 0.83 \times I_{F(AV)} + 0.034 \times I_{F(RMS)}^2$$

Table 5: Dynamic electrical characteristics (per diode)

Symbol	Parameter	Test conditions		Min.	Typ.	Max.	Unit
t _{rr}	Reverse recovery time	T _j = 25 °C	I _F = 1 A V _R = 30 V di _F /dt = -50 A/μs	-	35	50	ns
			I _F = 1 A V _R = 30 V di _F /dt = -100 A/μs	-	25	35	
I _{RM}	Reverse recovery current	T _j = 125 °C	I _F = 8 A V _R = 320 V di _F /dt = -200 A/μs	-	5.5	8	A
S _{factor}	Softness factor			-	0.4	-	-
t _{fr}	Forward recovery time	T _j = 25 °C	I _F = 8 A V _{FR} = 1.1 x V _{F(max)} di _F /dt = 100 A/μs	-		150	ns
V _{FP}	Forward recovery voltage			I _F = 8 A di _F /dt = 100 A/μs	-	2.9	

1.1 Characteristics (curves)

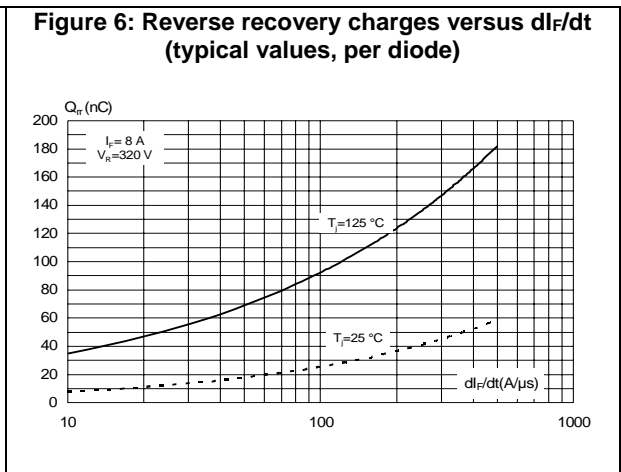
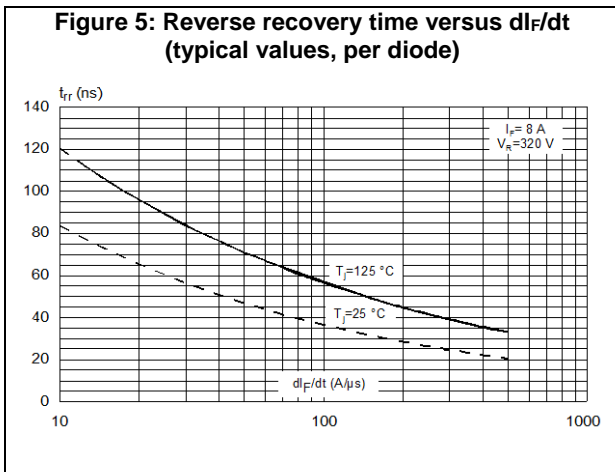
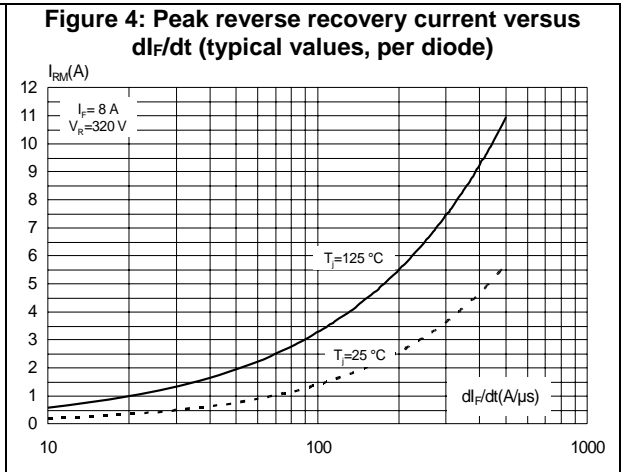
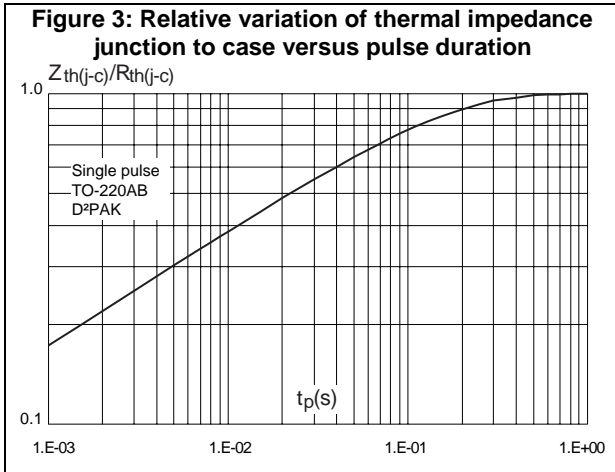
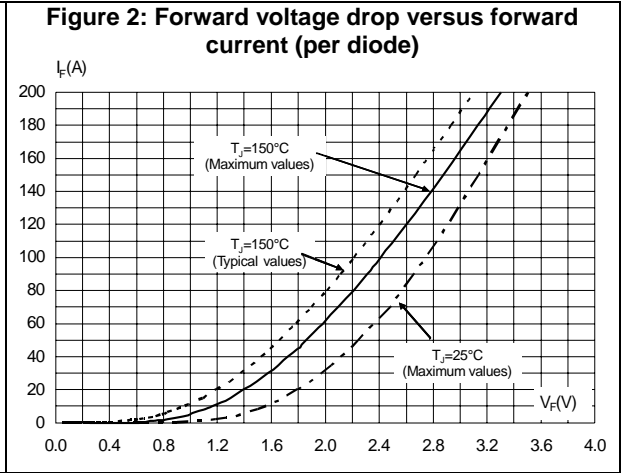
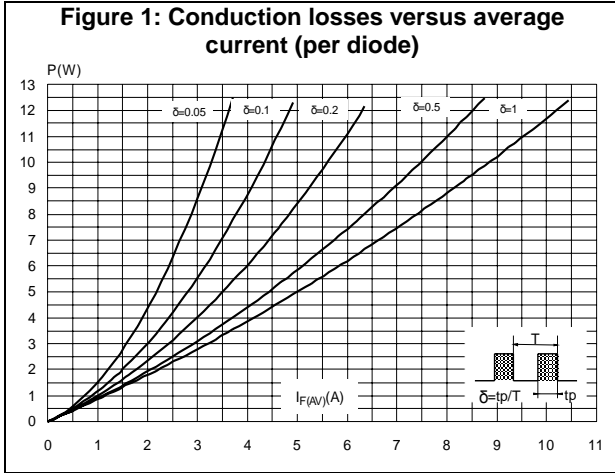

Figure 7: Relative variations of dynamic parameters versus junction temperature (reference: $T_j = 125^\circ\text{C}$)

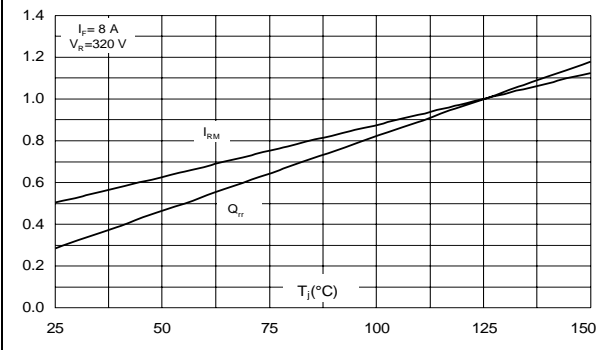

Figure 8: Transient peak forward voltage versus di_F/dt (typical values, per diode)

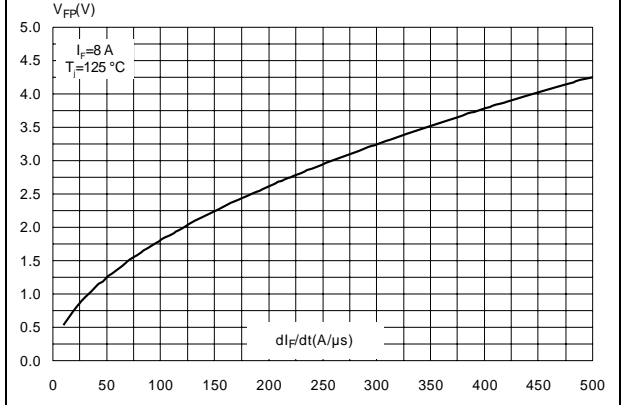

Figure 9: Forward recovery time versus di_F/dt (typical values, per diode)

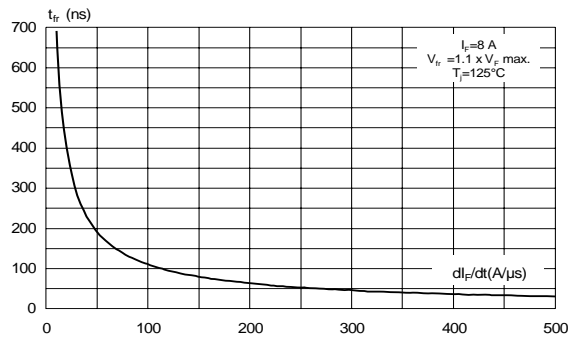

Figure 10: Junction capacitance versus reverse voltage applied (typical values, per diode)

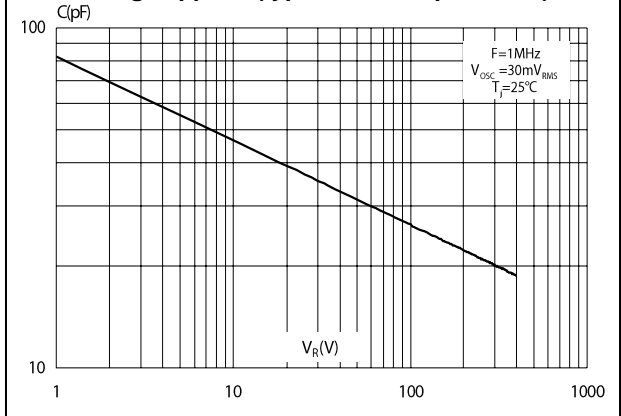
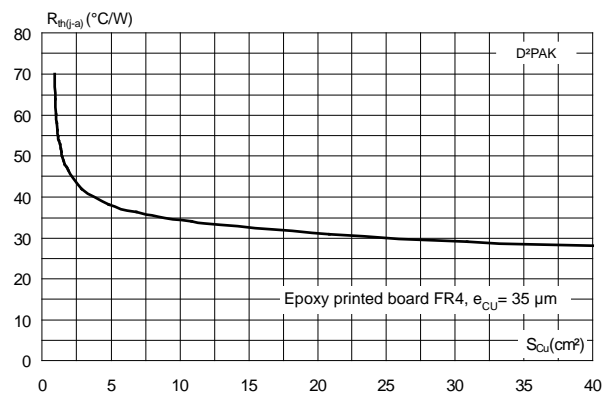

Figure 11: Thermal resistance junction to ambient versus copper surface under tab



2 Package information

In order to meet environmental requirements, ST offers these devices in different grades of ECOPACK® packages, depending on their level of environmental compliance. ECOPACK® specifications, grade definitions and product status are available at: www.st.com. ECOPACK® is an ST trademark.

- Cooling method: by conduction (C)
- Epoxy meets UL 94, V0
- Recommended torque value: 0.55 N·m (for TO-220AB)
- Maximum torque value: 0.7 N·m (for TO-220AB)

2.1 D²PAK package information

Figure 12: D²PAK package outline

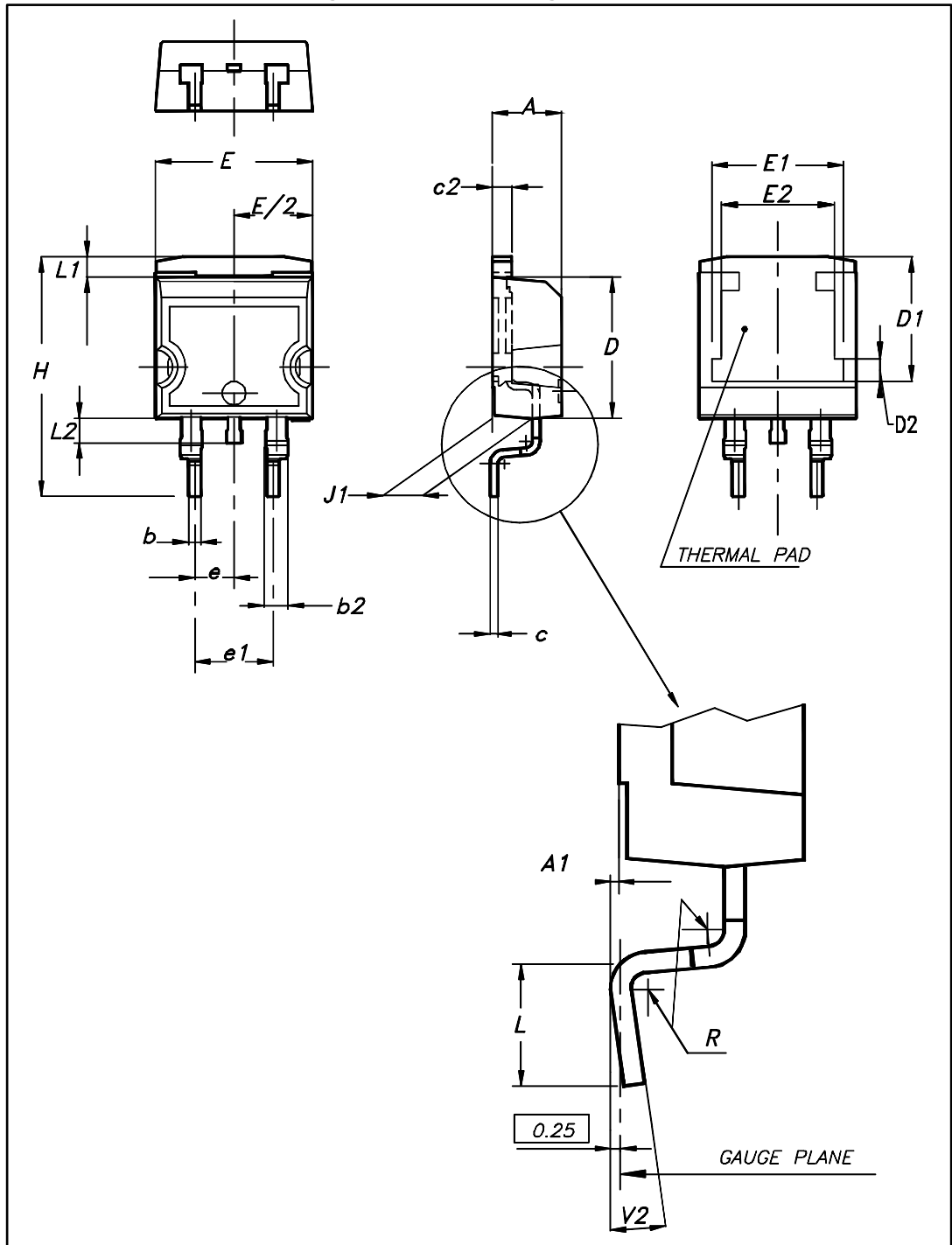

This package drawing may slightly differ from the physical package. However, all the specified dimensions are guaranteed.

Table 6: D²PAK package mechanical data

Ref.	Dimensions			
	Millimeters		Inches	
	Min.	Max.	Min.	Max.
A	4.36	4.60	0.172	0.181
A1	0.00	0.25	0.000	0.010
b	0.70	0.93	0.028	0.037
b2	1.14	1.70	0.045	0.067
c	0.38	0.69	0.015	0.027
c2	1.19	1.36	0.047	0.053
D	8.60	9.35	0.339	0.368
D1	6.90	8.00	0.272	0.311
D2	1.10	1.50	0.043	0.060
E	10.00	10.55	0.394	0.415
E1	8.10	8.90	0.319	0.346
E2	6.85	7.25	0.266	0.282
e	2.54 typ.		0.100	
e1	4.88	5.28	0.190	0.205
H	15.00	15.85	0.591	0.624
J1	2.49	2.90	0.097	0.112
L	1.90	2.79	0.075	0.110
L1	1.27	1.65	0.049	0.065
L2	1.30	1.78	0.050	0.070
R	0.4 typ.		0.015	
V2	0°	8°	0°	8°

Figure 13: D²PAK recommended footprint (dimensions in mm)

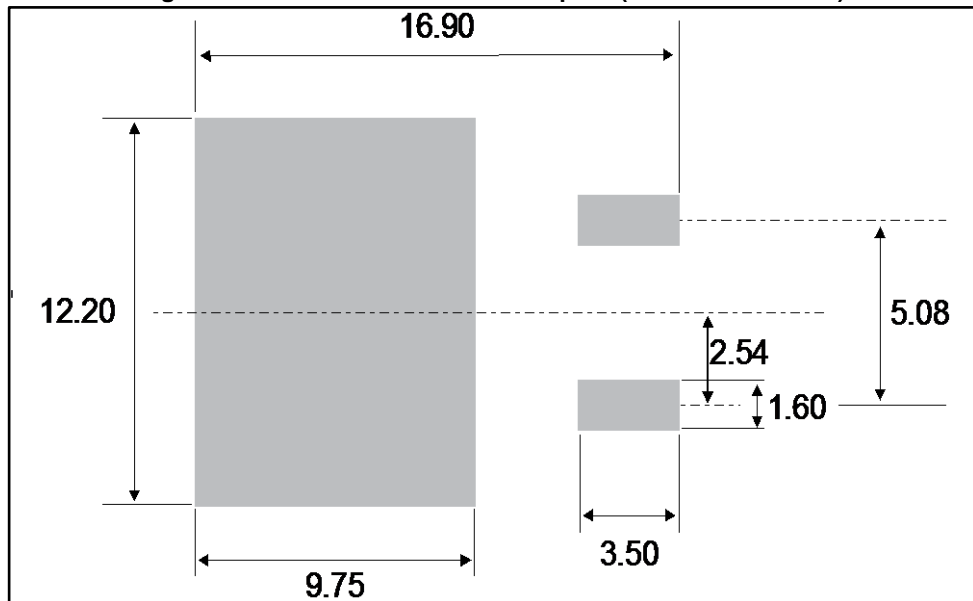

2.2 TO-220AB package information

Figure 14: TO-220AB package outline

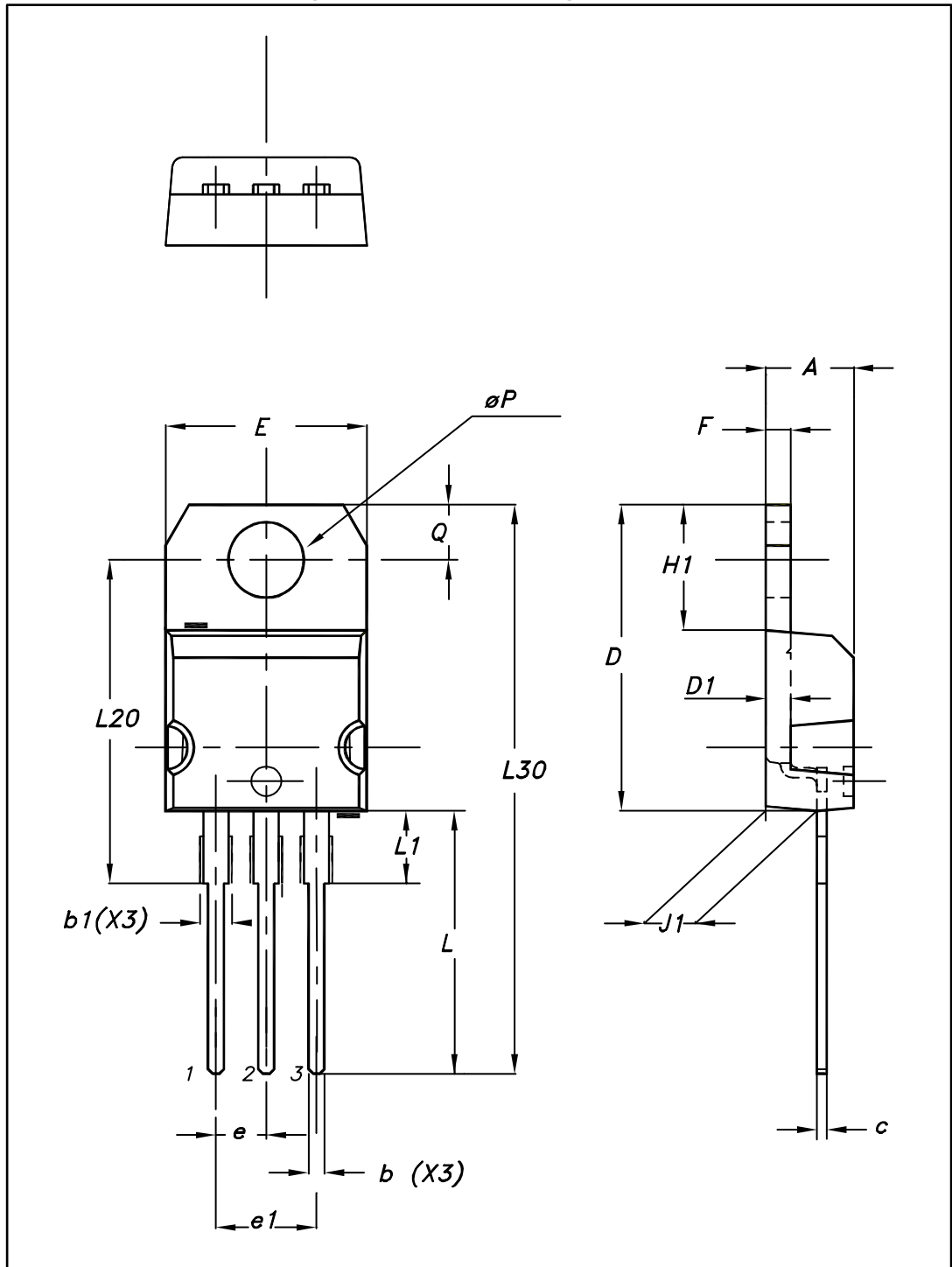

Table 7: TO-220AB package mechanical data

Ref.	Dimensions			
	Millimeters		Inches	
	Min.	Max.	Min.	Max.
A	4.40	4.60	0.173	0.181
b	0.61	0.88	0.240	0.035
b1	1.14	1.70	0.045	0.067
c	0.48	0.70	0.019	0.028
D	15.25	15.75	0.600	0.620
D1	1.27 typ.		0.050 typ.	
E	10.00	10.40	0.394	0.409
e	2.40	2.70	0.094	0.106
e1	4.95	5.15	0.195	0.203
F	1.23	1.32	0.048	0.052
H1	6.20	6.60	0.244	0.260
J1	2.40	2.72	0.094	0.107
L	13.00	14.00	0.512	0.551
L1	3.50	3.93	0.138	0.155
L20	16.40 typ.		0.646 typ.	
L30	28.90 typ.		1.138 typ.	
θP	3.75	3.85	0.148	0.152
Q	2.65	2.95	0.104	0.116

3 Ordering information

Table 8: Ordering information

Order code	Marking	Package	Weight	Base qty.	Delivery mode
STTH16R04CT	STTH16R04CT	TO-220AB	1.9 g	50	Tube
STTH16R04CG-TR	STTH16R04CG	D ² PAK	1.38 g	1000	Tape and reel

4 Revision history

Table 9: Document revision history

Date	Revision	Changes
31-Mar-2007	1	First issue.
02-Nov-2016	2	Removed device in TO-220FPAB. Updated features, Table 1: "Device summary" and package silhouettes in cover page. Updated Section 1: "Characteristics" , and Section 3: "Ordering information" . Updated Section 2.1: "D²PAK package information" .

IMPORTANT NOTICE – PLEASE READ CAREFULLY

STMicroelectronics NV and its subsidiaries ("ST") reserve the right to make changes, corrections, enhancements, modifications, and improvements to ST products and/or to this document at any time without notice. Purchasers should obtain the latest relevant information on ST products before placing orders. ST products are sold pursuant to ST's terms and conditions of sale in place at the time of order acknowledgement.

Purchasers are solely responsible for the choice, selection, and use of ST products and ST assumes no liability for application assistance or the design of Purchasers' products.

No license, express or implied, to any intellectual property right is granted by ST herein.

Resale of ST products with provisions different from the information set forth herein shall void any warranty granted by ST for such product.

ST and the ST logo are trademarks of ST. All other product or service names are the property of their respective owners.

Information in this document supersedes and replaces information previously supplied in any prior versions of this document.

© 2016 STMicroelectronics – All rights reserved