

### APPLICATIONS

- Induction Heating
- A.C. Motor Drives
- Snubber Diode
- Welding
- High Frequency Rectification
- UPS

### KEY PARAMETERS

$V_{RRM}$	<b>1600V</b>
$I_{F(AV)}$	<b>205A</b>
$I_{FSM}$	<b>3000A</b>
$Q_r$	<b>35<math>\mu</math>C</b>
$t_{rr}$	<b>3.2<math>\mu</math>s</b>

### FEATURES

- Thermal Fatigue Free Pressure Contact
- High Surge Capability
- Low Recovery Charge

### VOLTAGE RATINGS

Type Number	Repetitive Peak Reverse Voltage $V_{RRM}$ V	Conditions
SV15 16F M or K	1600	$V_{RSM} = V_{RRM} + 100V$
SV15 14F M or K	1400	
SV15 12F M or K	1200	
SV15 10F M or K	1000	
SV15 08F M or K	800	
SV15 06F M or K	600	

For 1/2" 20 UNF thread, add suffix K, e.g. SV15 16FK.  
 For M12 thread, add suffix M, e.g. SV15 16FM.  
 For stud anode add 'R' to type number, e.g. SV15 16FMR.  
 For outline DO8C add suffix 'C' to type number, e.g. SV15 16FKC.

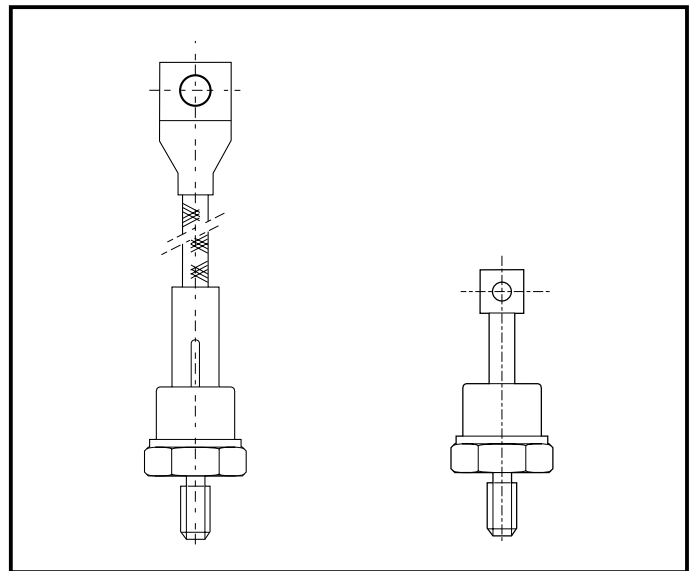

**Outline type codes: DO8 and DO8C.**  
**See Package Details for further information.**

### CURRENT RATINGS

Symbol	Parameter	Conditions	Max.	Units
$I_{F(AV)}$	Mean forward current	Half wave resistive load, $T_{case} = 65^{\circ}C$	205	A
$I_{F(RMS)}$	RMS value	$T_{case} = 65^{\circ}C$	236	A

## SV15..F

### SURGE RATINGS

Symbol	Parameter	Conditions	Max.	Units
$I_{FSM}$	Surge (non-repetitive) forward current	10ms half sine; with 0% $V_{RRM}$ , $T_j = 150^\circ\text{C}$	3.0	kA
$I^2t$	$I^2t$ for fusing		$45 \times 10^3$	$\text{A}^2\text{s}$
$I_{FSM}$	Surge (non-repetitive) forward current	10ms half sine; with 50% $V_{RRM}$ , $T_j = 150^\circ\text{C}$	-	kA
$I^2t$	$I^2t$ for fusing		-	$\text{A}^2\text{s}$

### THERMAL AND MECHANICAL DATA

Symbol	Parameter	Conditions	Min.	Max.	Units
$R_{th(j-c)}$	Thermal resistance - junction to case	dc	-	0.23	$^\circ\text{C}/\text{W}$
$R_{th(c-h)}$	Thermal resistance - case to heatsink	Mounting torque 15Nm with mounting compound	-	0.02	$^\circ\text{C}/\text{W}$
$T_{vj}$	Virtual junction temperature	On-state (conducting)	-	150	$^\circ\text{C}$
$T_{stg}$	Storage temperature range		-55	200	$^\circ\text{C}$
-	Mounting torque		12.0	15.0	Nm

### CHARACTERISTICS

Symbol	Parameter	Conditions	Typ.	Max.	Units
$V_{FM}$	Forward voltage	At 450A peak, $T_{case} = 25^\circ\text{C}$	-	1.6	V
$I_{RRM}$	Peak reverse current	At $V_{RRM}$ , $T_{case} = 150^\circ\text{C}$	-	20	mA
$t_{rr}$	Reverse recovery time	$I_F = 450\text{A}$ , $di_{RR}/dt = 10\text{A}/\mu\text{s}$ $T_{case} = 125^\circ\text{C}$ , $V_R = 100\text{V}$	-	3.2	$\mu\text{s}$
$Q_{RA1}$	Recovered charge (50% chord)		-	35	$\mu\text{C}$
$I_{RM}$	Reverse recovery current		-	21	A
K	Soft factor		-	-	-
$V_{TO}$	Threshold voltage	At $T_{vj} = 150^\circ\text{C}$	-	1.0	V
$r_T$	Slope resistance	At $T_{vj} = 150^\circ\text{C}$	-	1.33	$\text{m}\Omega$
$V_{FRM}$	Forward recovery voltage	$di/dt = 1000\text{A}/\mu\text{s}$ , $T_j = 125^\circ\text{C}$	-	-	V

**DEFINITION OF K FACTOR AND  $Q_{RA1}$**

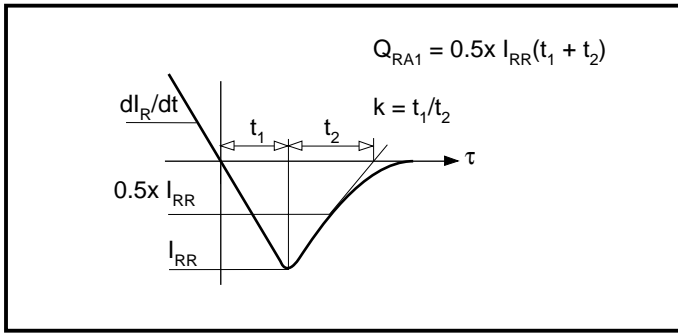

**CURVES**

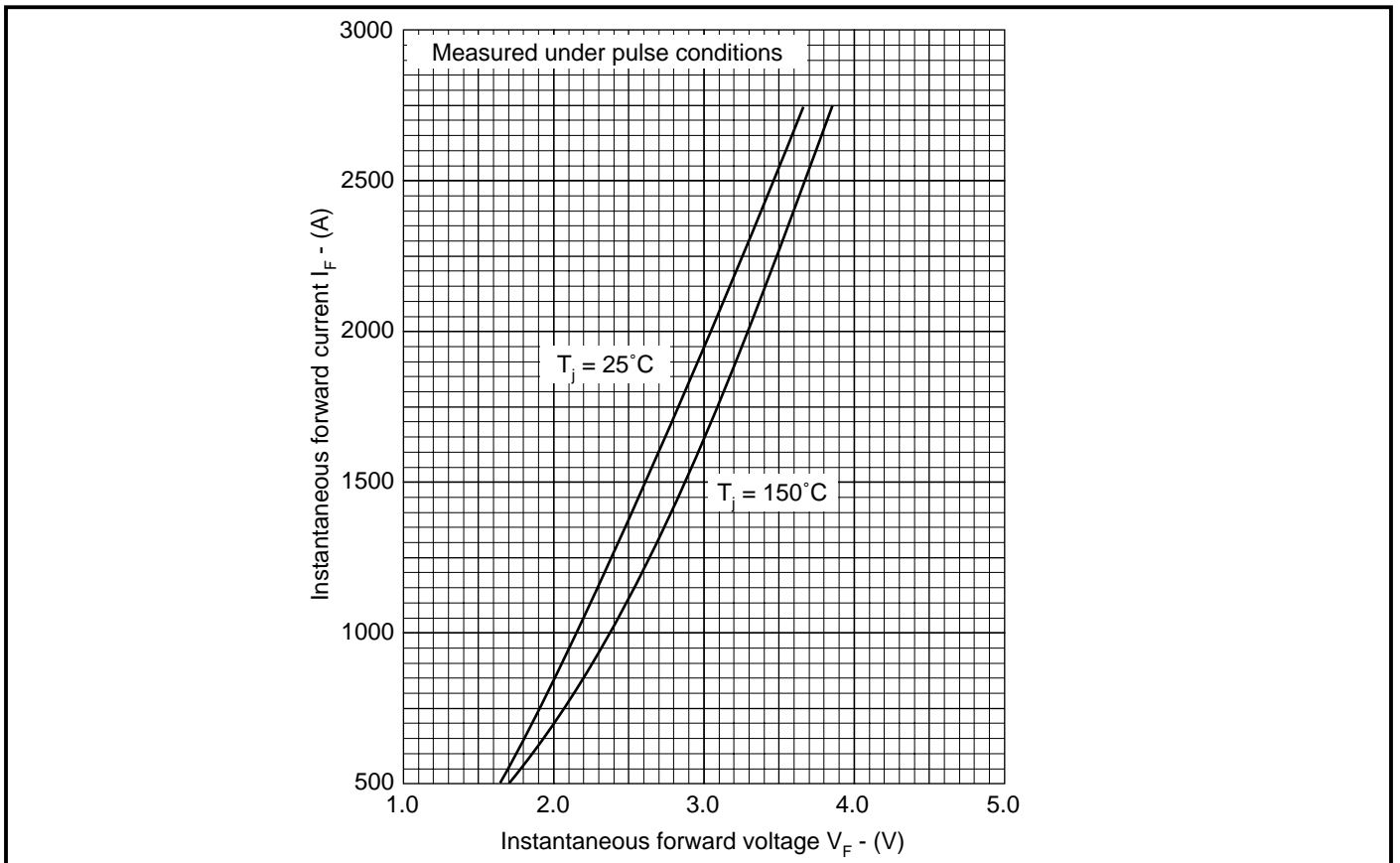

**Fig.1 Maximum (limit) forward characteristics**

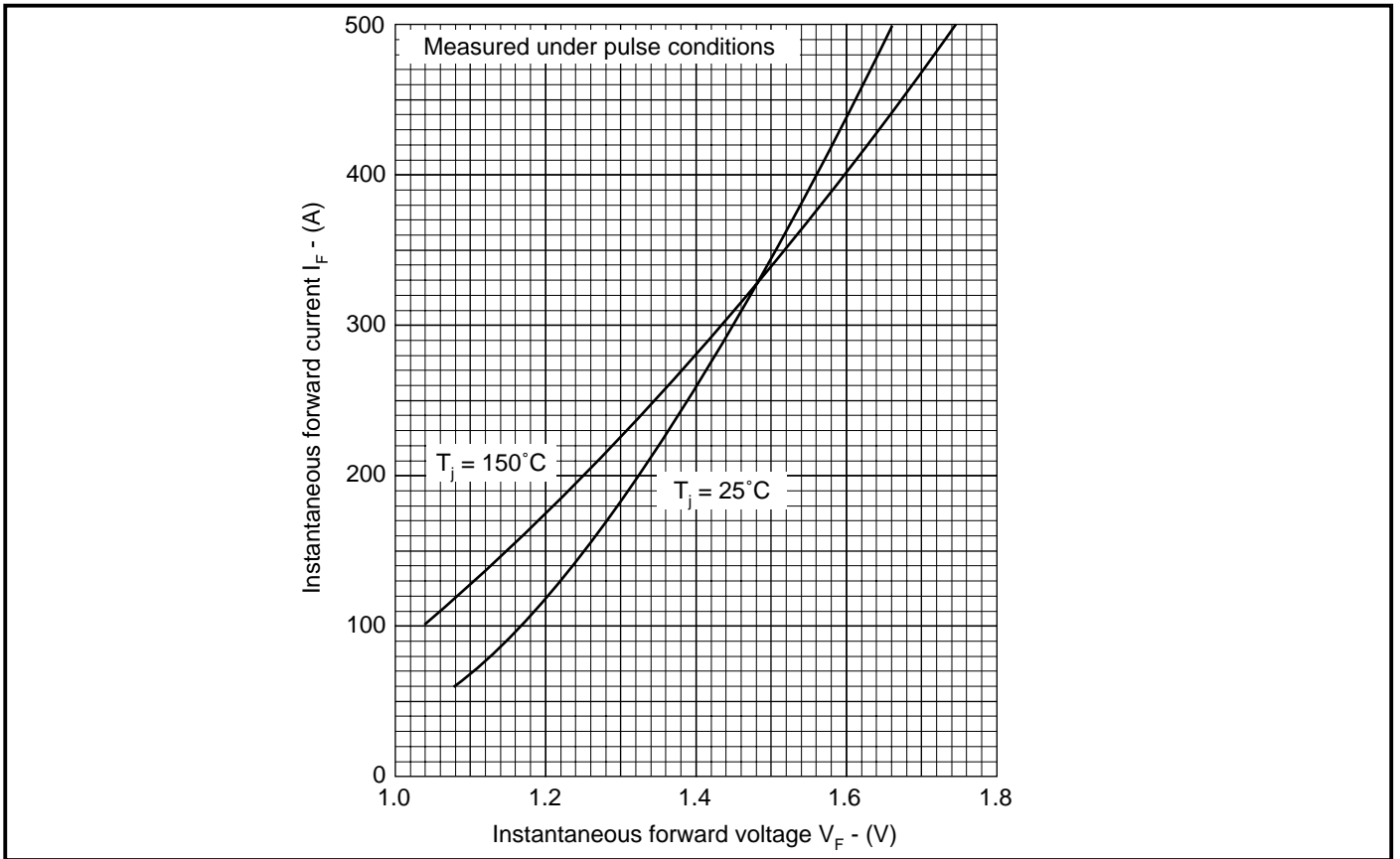

Fig.2 Maximum (limit) forward characteristics

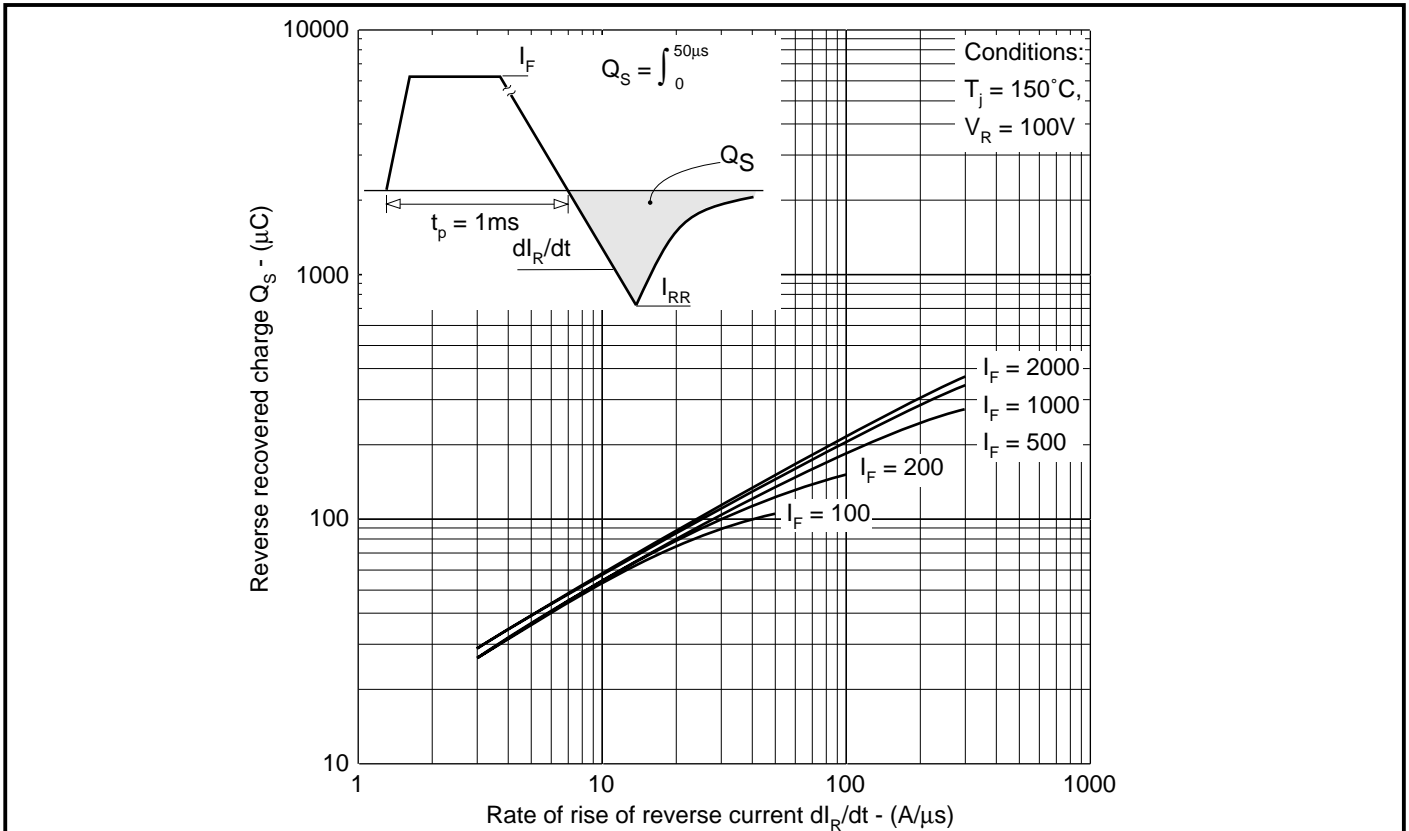

Fig.3 Recovered charge

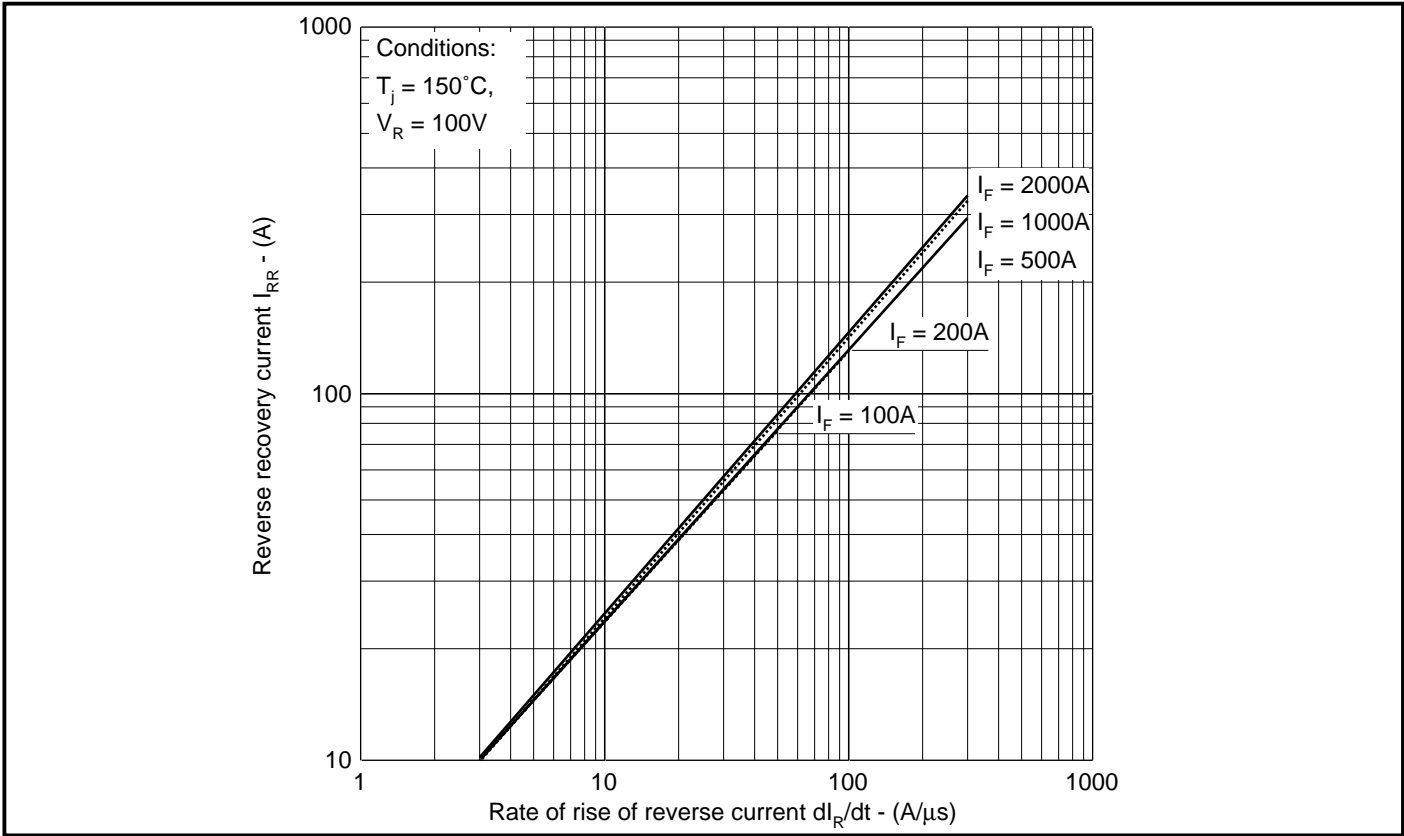

Fig.4 Typical reverse recovery current vs rate of rise of reverse current

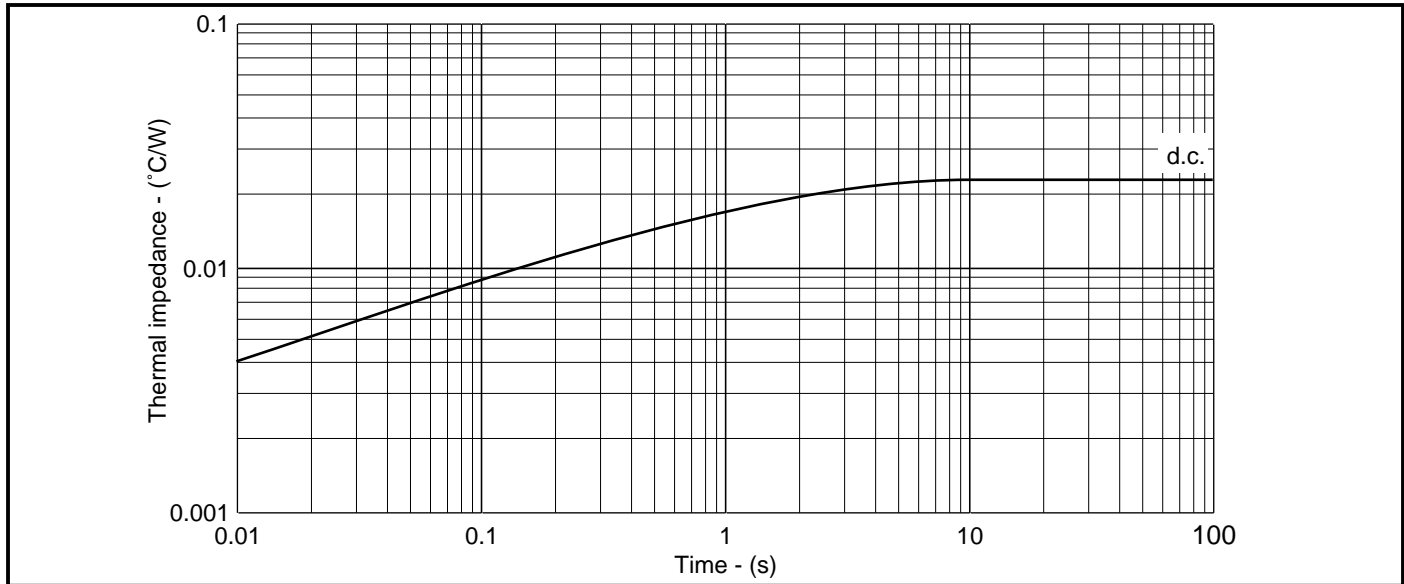
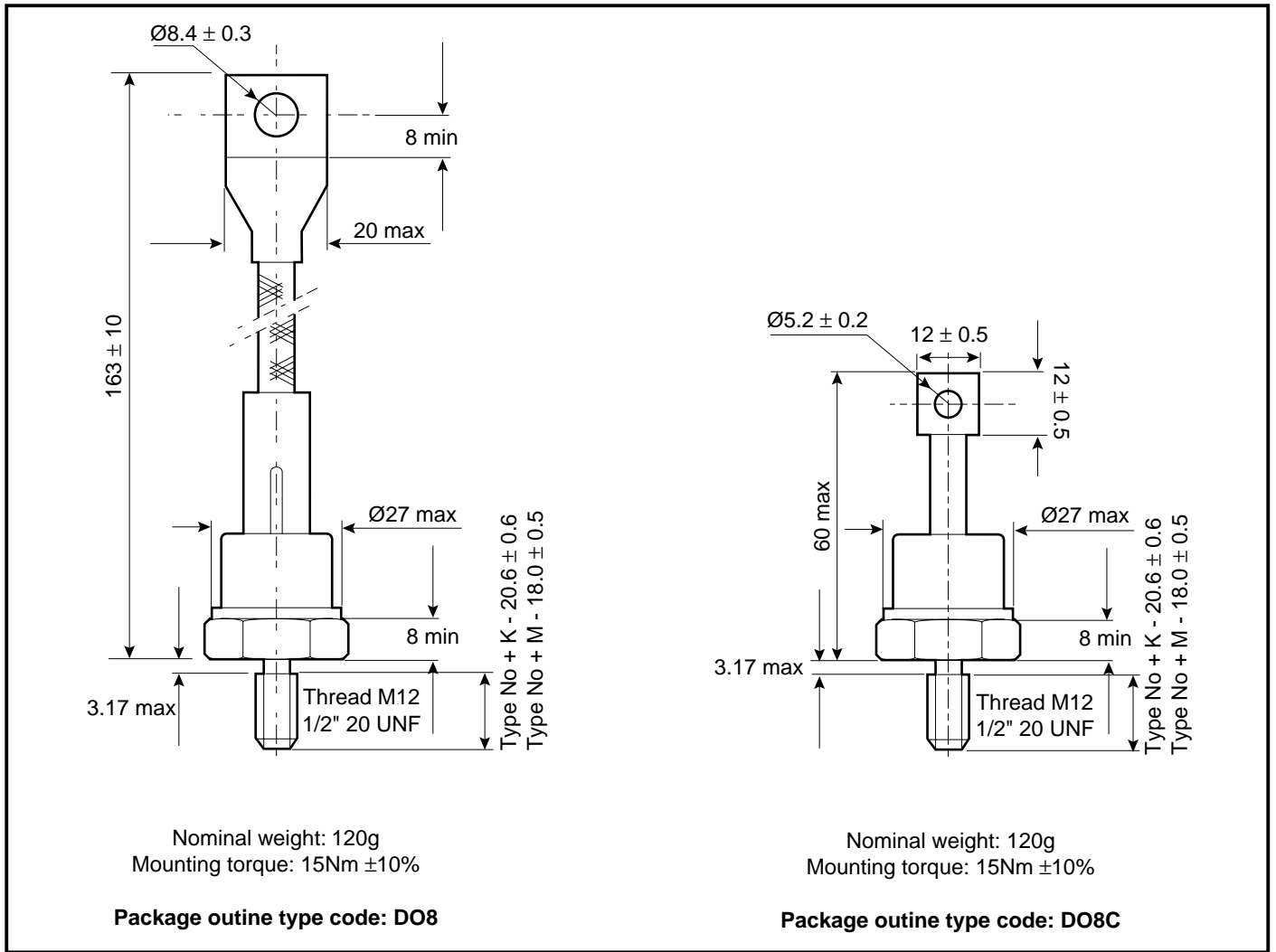

Fig.5 Maximum (limit) transient thermal impedance - junction to case - ( $^\circ\text{C}/\text{W}$ )

# SV15..F

## PACKAGE DETAILS

For further package information, please contact your local Customer Service Centre. All dimensions in mm, unless stated otherwise. DO NOT SCALE.



## ASSOCIATED PUBLICATIONS

Title	Application Note
	Number
Calculating the junction temperature or power semiconductors	AN4506
Thyristor and diode measurement with a multi-meter	AN4853
Use of $V_{TO}$ , $r_T$ on-state characteristic	AN5001

## POWER ASSEMBLY CAPABILITY

The Power Assembly group was set up to provide a support service for those customers requiring more than the basic semiconductor, and has developed a flexible range of heatsink / clamping systems in line with advances in device types and the voltage and current capability of our semiconductors.

We offer an extensive range of air and liquid cooled assemblies covering the full range of circuit designs in general use today. The Assembly group continues to offer high quality engineering support dedicated to designing new units to satisfy the growing needs of our customers.

Using the up to date CAD methods our team of design and applications engineers aim to provide the Power Assembly Complete solution (PACs).

## HEATSINKS

Power Assembly has its own proprietary range of extruded aluminium heatsinks. They have been designed to optimise the performance of our semiconductors. Data with respect to air natural, forced air and liquid cooling (with flow rates) is available on request.

For further information on device clamps, heatsinks and assemblies, please contact your nearest Sales Representative or the factory.



<http://www.dynexsemi.com>

e-mail: [power\\_solutions@dynexsemi.com](mailto:power_solutions@dynexsemi.com)

### HEADQUARTERS OPERATIONS

#### DYNEX SEMICONDUCTOR LTD

Doddington Road, Lincoln.  
Lincolnshire. LN6 3LF. United Kingdom.  
Tel: 00-44-(0)1522-500500  
Fax: 00-44-(0)1522-500550

#### DYNEX POWER INC.

Suite 410, 99 Bank Street,  
Ottawa, Ontario, Canada K1P 6B9.  
Tel: 613.723.7035  
Fax: 613.723.1518  
Toll Free: 1.888.33.DYNEX (39639)

### CUSTOMER SERVICE CENTRES

**Mainland Europe** Tel: +33 (0)1 58 04 91 00. Fax: +33 (0)1 46 38 51 33  
**North America** Tel: (613) 723-7035. Fax: (613) 723-1518.  
**UK, Scandinavia & Rest Of World** Tel: +44 (0)1522 500500. Fax: +44 (0)1522 500020

### SALES OFFICES

**Mainland Europe** Tel: +33 (0)1 58 04 91 00. Fax: +33 (0)1 46 38 51 33  
**North America** Tel: (613) 723-7035. Fax: (613) 723-1518. Toll Free: 1.888.33.DYNEX (39639) /  
Tel: (949) 733-3005. Fax: (949) 733-2986.  
**UK, Scandinavia & Rest Of World** Tel: +44 (0)1522 500500. Fax: +44 (0)1522 500020

These offices are supported by Representatives and Distributors in many countries world-wide.  
© Dynex Semiconductor 2000 Publication No. DS4209-3 Issue No. 3.0 January 2000  
TECHNICAL DOCUMENTATION – NOT FOR RESALE. PRINTED IN UNITED KINGDOM

### Datasheet Annotations:

Dynex Semiconductor annotate datasheets in the top right hand corner of the front page, to indicate product status. The annotations are as follows:-

**Target Information:** This is the most tentative form of information and represents a very preliminary specification. No actual design work on the product has been started.

**Preliminary Information:** The product is in design and development. The datasheet represents the product as it is understood but details may change.

**Advance Information:** The product design is complete and final characterisation for volume production is well in hand.

**No Annotation:** The product parameters are fixed and the product is available to datasheet specification.

This publication is issued to provide information only which (unless agreed by the Company in writing) may not be used, applied or reproduced for any purpose nor form part of any order or contract nor to be regarded as a representation relating to the products or services concerned. No warranty or guarantee express or implied is made regarding the capability, performance or suitability of any product or service. The Company reserves the right to alter without prior notice the specification, design or price of any product or service. Information concerning possible methods of use is provided as a guide only and does not constitute any guarantee that such methods of use will be satisfactory in a specific piece of equipment. It is the user's responsibility to fully determine the performance and suitability of any equipment using such information and to ensure that any publication or data used is up to date and has not been superseded. These products are not suitable for use in any medical products whose failure to perform may result in significant injury or death to the user. All products and materials are sold and services provided subject to the Company's conditions of sale, which are available on request.

All brand names and product names used in this publication are trademarks, registered trademarks or trade names of their respective owners.