

CERAMIC SURGE ABSORBERS (VARISTORS)

SVC

SVC CHARACTERISTIC CURVES

V - I CURVE

- Small - current region of V - I curve

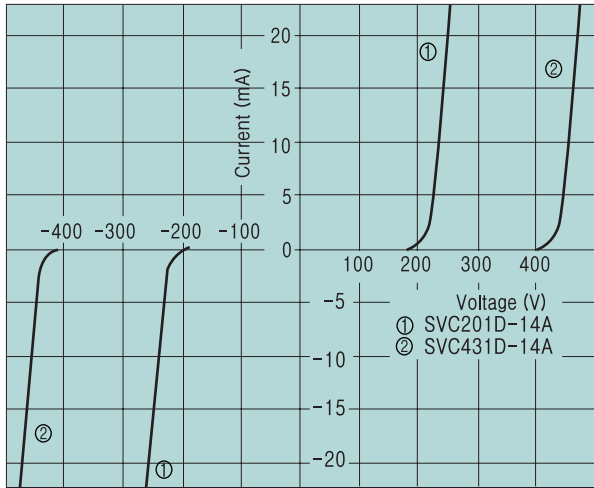

- Temporary power frequency over voltage capability

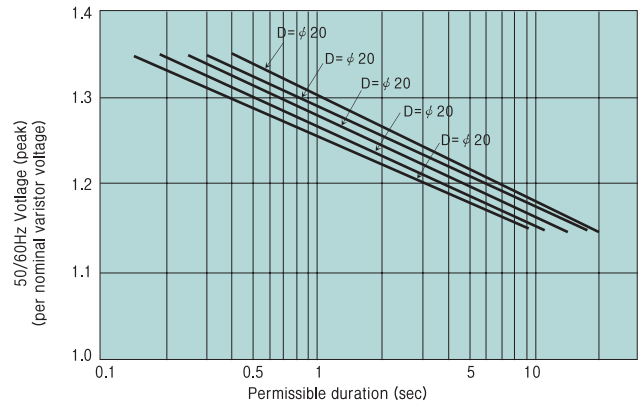

B TYPE

- Withstand discharge impulse current characteristics (Typical)

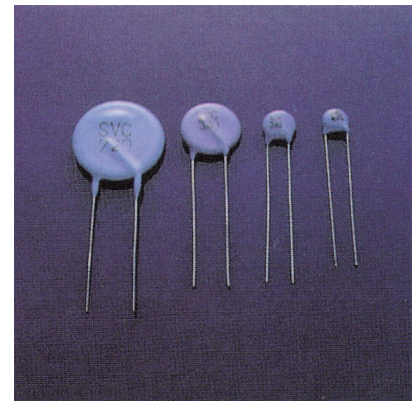
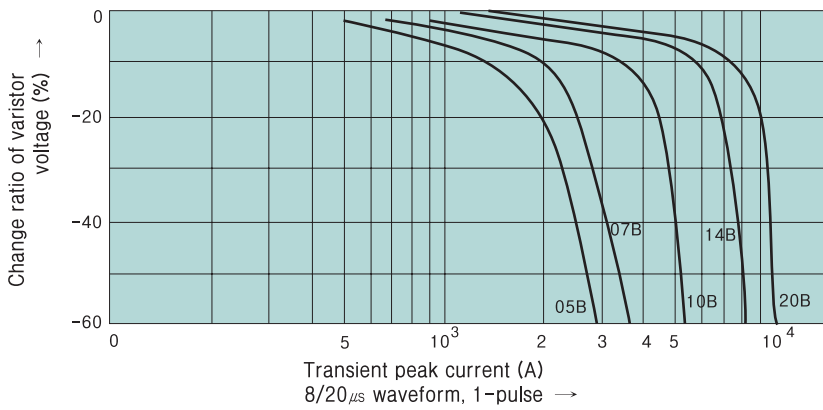

A TYPE

- Withstand discharge impulse current characteristics (Typical)

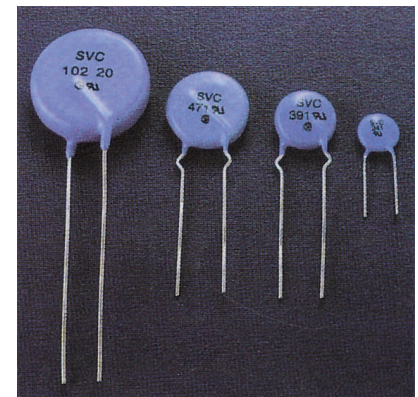
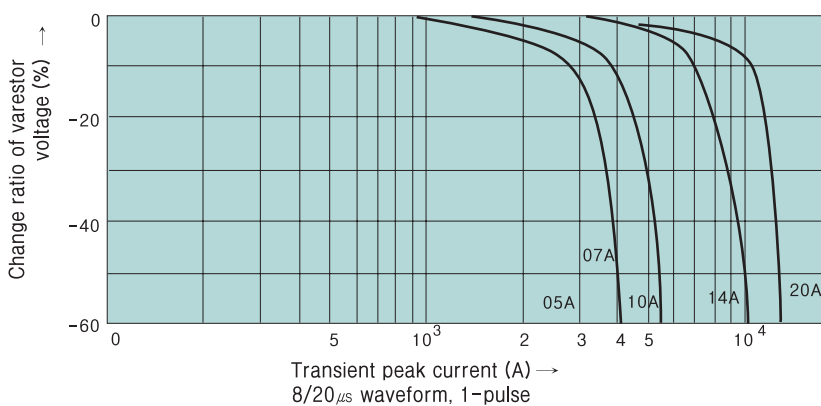

CERAMIC SURGE ABSORBERS (VARISTORS)

SVC

SPECIFICATION

Device Type	Chip Element Size	Maximum ratings					Characteristics					
		Applied voltage		Transient			Nominal varistor ^④ peak voltage			Max. clamping ^⑤ voltage @ test current (8/20 μ s)		Typical capacitance
	RMS 50/60Hz (25 °C)	DC (25 °C)	Energy ^②	Average power dissipation	Peak ^③ current (8/20 μ s)	Vnom (Volts)						
	V acm (Volts)	V dcm (Volts)	W tm (Joules)	Ptam (Watts)	Itm (Amps)		Min (Volts)	Max (Volts)				
SVC 180D-05B SVC 180D-07B SVC 180D-10B SVC 180D-14B SVC 180D-20B	5 7 10 14 20	11	14	0.3 0.8 1.5 3.5 10.0	0.01 0.02 0.05 0.1 0.2	125 250 500 1000 2000	18	16	20	40 36 36 36 36	1 2.5 5 10 20	1700 3500 7000 1400 28000
SVC 220D-05B SVC 220D-07B SVC 220D-10B SVC 220D-14B SVC 220D-20B	5 7 10 14 20	14	18	0.4 0.9 2.0 4.0 13.0	0.01 0.02 0.05 0.1 0.2	125 250 500 1000 2000	22	20	24	48 43 43 43 43	1 2.5 5 10 20	1200 2500 5000 11000 22000
SVC 270D-05B SVC 270D-07B SVC 270D-10B SVC 270D-14B SVC 270D-20B	5 7 10 14 20	17	22	0.5 1.0 2.5 5.0 15.0	0.01 0.02 0.05 0.1 0.2	125 250 500 1000 2000	27	24	30	60 53 53 54 53	1 2.5 5 10 20	1100 2000 4500 9000 18000
SVC 330D-05B SVC 330D-07B SVC 330D-10B SVC 330D-14B SVC 330D-20B	5 7 10 14 20	20	26	0.6 1.2 3.0 6.0 20.0	0.01 0.02 0.05 0.1 0.2	125 250 500 1000 2000	33	30	36	73 65 65 65 65	1 2.5 5 10 20	1000 2000 4000 8000 16000
SVC 390D-05B SVC 390D-07B SVC 390D-10B SVC 390D-14B SVC 390D-20B	5 7 10 14 20	25	31	0.8 1.5 3.5 7.0 24.0	0.01 0.02 0.05 0.1 0.2	125 250 500 1000 2000	39	35	43	86 77 77 77 77	1 2.5 5 10 20	800 1600 3200 6500 13000
SVC 470D-05B SVC 470D-07B SVC 470D-10B SVC 470D-14B SVC 470D-20B	5 7 10 14 20	30	38	1.0 1.8 4.5 8.5 30.0	0.01 0.02 0.05 0.1 0.2	125 250 500 1000 2000	47	42	52	104 93 93 93 93	1 2.5 5 10 20	700 1400 2800 5500 11000
SVC 560D-05B SVC 560D-07B SVC 560D-10B SVC 560D-14B SVC 560D-20B	5 7 10 14 20	35	45	1.0 2.2 5.5 10.5 35.0	0.01 0.02 0.05 0.1 0.2	125 250 500 1000 2000	56	50	62	123 110 110 110 110	1 2.5 5 10 20	600 1300 2500 5000 10000
SVC 680D-05B SVC 680D-07B SVC 680D-10B SVC 680D-14B SVC 680D-20B	5 7 10 14 20	40	56	1.2 2.5 6.5 12.0 40.0	0.01 0.02 0.05 0.1 0.2	125 250 500 1000 2000	68	61	75	150 135 135 135 135	1 2.5 5 10 20	500 1000 2000 4000 8000
SVC 820D-05B SVC 820D-07B SVC 820D-10B SVC 820D-14B SVC 820D-20B	5 7 10 14 20	50	65	1.7 3.5 8.0 14.0 27.0	0.1 0.25 0.4 0.6 1.0	250 600 1250 2500 4000	82	74	90	145 135 135 135 135	5 10 25 50 100	400 800 1500 3000 6000
SVC 101D-05B SVC 101D-07B SVC 101D-10B SVC 101D-14B SVC 101D-20B	5 7 10 14 20	60	85	2.0 4.0 10.0 18.0 30.0	0.1 0.25 0.4 0.6 1.0	250 600 1250 2500 4000	100	90	110	175 165 165 165 165	5 10 25 50 100	350 700 1500 3000 6000
SVC 121D-05B SVC 121D-07B SVC 121D-10B SVC 121D-14B SVC 121D-20B	5 7 10 14 20	75	100	2.5 5.0 12.0 20.0 40.0	0.1 0.25 0.4 0.6 1.0	250 600 1250 2500 4000	120	108	132	210 200 200 200 200	5 10 25 50 100	350 700 1300 2600 5200
SVC 151D-05B SVC 151D-07B SVC 151D-10B SVC 151D-14B SVC 151D-20B	5 7 10 14 20	95	125	3.0 6.0 16.0 25.0 50.0	0.1 0.25 0.4 0.6 1.0	250 600 1250 2500 4000	150	135	165	260 250 250 250 250	5 10 25 50 100	250 500 1000 2000 4000
SVC 201D-05B SVC 201D-07B SVC 201D-10B SVC 201D-14B SVC 201D-20B	5 7 10 14 20	130	170	4.0 10.0 20.0 35.0 70.0	0.1 0.25 0.4 0.6 1.0	250 600 1250 2500 4000	200	185	225	355 340 340 340 340	5 10 25 50 100	200 400 800 1600 3200
SVC 221D-05B SVC 221D-07B SVC 221D-10B SVC 221D-14B SVC 221D-20B	5 7 10 14 20	140	180	4.5 10.0 23.0 40.0 75.0	0.1 0.25 0.4 0.6 1.0	250 600 1250 2500 4000	220	198	242	380 360 360 360 360	5 10 25 50 100	170 350 700 1400 2800
SVC 241D-05B SVC 241D-07B SVC 241D-10B SVC 241D-14B SVC 241D-20B	5 7 10 14 20	150	200	5.0 10.0 25.0 40.0 80.0	0.1 0.25 0.4 0.6 1.0	250 600 1250 2500 4000	240	216	264	415 395 395 395 395	5 10 25 50 100	170 350 700 1300 2600

CERAMIC SURGE ABSORBERS (VARISTORS)

SVC

Device Type	Dia (mm)	Vacm (Volts)	Vdcm (Volts)	Wtm (Joules)	Ptam (Watts)	Itm (Amps)	Vnom (Volts)	Tolerance		VC (Volts)	Ip (Amps)	f=1kHz (pF)
								Min (Volts)	Max (Volts)			
SVC 271D-05A	5	175	225	6.0	0.1	250	270	247	303	475	5	150
SVC 271D-07A	7			12.0	0.25	600				455	10	300
SVC 271D-10A	10			30.0	0.4	1250				455	25	600
SVC 271D-14A	14			50.0	0.6	2500				455	50	1200
SVC 271D-20A	20			90.0	1.0	4000				455	100	2400
SVC 361D-05A	5	230	300	7.5	0.1	250	360	324	396	620	5	120
SVC 361D-07A	7			15.0	0.25	600				595	10	250
SVC 361D-10A	10			35.0	0.4	1250				595	25	500
SVC 361D-14A	14			65.0	0.6	2500				595	50	1000
SVC 361D-20A	20			120.0	1.0	4000				595	100	2000
SVC 391D-05A	5	250	320	8.0	0.1	250	390	351	429	675	5	110
SVC 391D-07A	7			17.0	0.25	600				650	10	220
SVC 391D-10A	10			40.0	0.4	1250				650	25	450
SVC 391D-14A	14			70.0	0.6	2500				650	50	900
SVC 391D-20A	20			130.0	1.0	4000				650	100	1800
SVC 431D-05A	5	275	350	9.0	0.1	250	430	387	473	754	5	100
SVC 431D-07A	7			20.0	0.25	600				710	10	200
SVC 431D-10A	10			45.0	0.4	1250				710	25	400
SVC 431D-14A	14			75.0	0.6	2500				710	50	800
SVC 431D-20A	20			140.0	1.0	4000				710	100	1600
SVC 471D-05A	5	300	385	10.0	0.1	250	470	423	517	810	5	80
SVC 471D-07A	7			20.0	0.25	600				775	10	170
SVC 471D-10A	10			45.0	0.4	1250				775	25	350
SVC 471D-14A	14			80.0	0.6	2500				775	50	700
SVC 471D-20A	20			150.0	1.0	4000				775	100	1400
SVC 561D-10A	10	350	460	45.0	0.4	1250	560	504	616	920	25	300
SVC 561D-14A	14			85.0	0.6	2500				920	50	600
SVC 561D-20A	20			150.0	1.0	4000				920	100	1200
SVC 621D-10A	10	385	550	45.0	0.4	1250	620	558	682	1025	25	270
SVC 621D-14A	14			85.0	0.6	2500				1025	50	550
SVC 621D-20A	20			150.0	1.0	4000				1025	100	1100
SVC 681D-10A	10	420	560	45.0	0.4	1250	680	612	748	1120	25	250
SVC 681D-14A	14			90.0	0.6	2500				1120	50	500
SVC 681D-20A	20			160.0	1.0	4000				1120	100	1000
SVC 751D-10A	10	460	615	50.0	0.4	1250	750	675	825	1240	25	220
SVC 751D-14A	14			100.0	0.6	2500				1240	50	450
SVC 751D-20A	20			175.0	1.0	4000				1240	100	900
SVC 781D-10A	10	485	640	50.0	0.4	1250	780	702	858	1290	25	220
SVC 781D-14A	14			105.0	0.6	2500				1290	50	440
SVC 781D-20A	20			180.0	1.0	4000				1290	100	880
SVC 821D-10A	10	510	670	55.0	0.4	1250	820	738	902	1355	25	210
SVC 821D-14A	14			110.0	0.6	2500				1355	50	420
SVC 821D-20A	20			190.0	1.0	4000				1355	100	840
SVC 911D-10A	10	550	745	60.0	0.4	1250	910	819	1001	1500	25	180
SVC 911D-14A	14			120.0	0.6	2500				1500	50	380
SVC 911D-20A	20			215.0	1.0	4000				1500	100	750
SVC 102D-10A	10	625	825	65.0	0.4	1250	1000	900	1100	1650	25	180
SVC 102D-14A	14			130.0	0.6	2500				1650	50	350
SVC 102D-20A	20			230.0	1.0	4000				1650	100	700
SVC 112D-10A	10	680	895	70.0	0.4	1250	1100	990	1210	1815	25	150
SVC 112D-14A	14			140.0	0.6	2500				1815	50	300
SVC 112D-20A	20			250.0	1.0	4000				1815	100	600
SVC 182D-10A	14	1000	1465	24.0	0.6	2500	1800	1620	1980	2970	50	200
SVC 182D-14A	20			400.0	1.0	4000				2970	100	400

Notes :

- ① The waveform of the maximum DC applied voltage is flat. When a ripple voltage as from a rectifier source is supplied make sure that the peak voltage is kept under the Vdcm.
An AC applied voltage(50/60Hz) form a sine wavelshape.
When the distortion in the waveform is extensive make sure that the peak voltage is less than $\sqrt{2}$ times the Vacm.
- ② Energy : Wtm
Transient energy ratings are given in the Wtm column of the specifications in Joules (watt-second).
The rating is the maximum allowable energy for a single impulse of 2ms square-waveform current with continuous voltage applied. Energy ratings are based on a shift of Vnom of less than $\pm 10\%$ of initial value.
- ③ Transient peak current (Itm)
The peak current rating. Itm. of varistor is based on an 8/20 μ s test impulse wavelshape.

This peak current is the maximum peak current in which the nominal varistor voltage shift does not exceed $\pm 10\%$ when the test impulse is applied twice at 5 minutes intervals.

- ④ Nominal varistor voltage : Vnom
Indicates the varistor terminal voltage measured with a 1mA DC applied. -0.1mA DC in the case of the 0.5A and 05B series.
 - ⑤ Maximum clamping voltage : Vc
Indicates the peak terminal voltage measured with an 8/20 μ s impulse current applied.
- Operating ambient temperature : -40°C to +80°C
 - Storage temperature : -40°C to +125°C
 - UL and CSA recognized (UL 1449, UL 497B or UL 1414, CSA)
SVC varistors have been tested by Underwriter's Laboratories, Inc. and Canadian Standards Association
UL File No. E97754, E151195, E154171.
CSA File No. LR78923.

CERAMIC SURGE ABSORBERS (VARISTORS)

SVC

DIMENSIONS (Unit : mm)

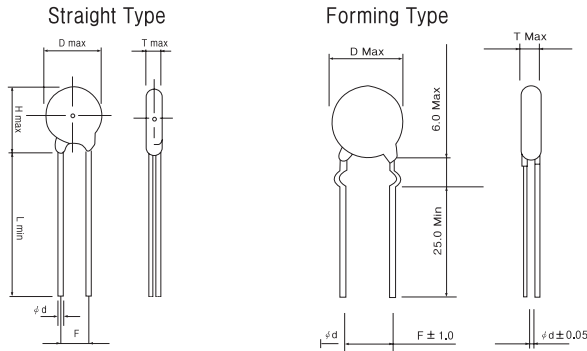

B TYPE

TYPE	Tmax	Dmax	Hmax	Lmin	F	φ d
SVC 180D-05B	4.5	7.5	10.0	25	5.0	0.55
SVC 220D-05B	4.5	7.5	10.0	25	5.0	0.55
SVC 270D-05B	4.5	7.5	10.0	25	5.0	0.55
SVC 330D-05B	4.5	7.5	10.0	25	5.0	0.55
SVC 390D-05B	4.5	7.5	10.0	25	5.0	0.55
SVC 470D-05B	4.5	7.5	10.0	25	5.0	0.55
SVC 560D-05B	4.5	7.5	10.0	25	5.0	0.55
SVC 680D-05B	4.5	7.5	10.0	25	5.0	0.55
SVC 180D-07D	4.5	9.0	10.0	25	5.0	0.55
SVC 220D-07D	4.5	9.0	10.0	25	5.0	0.55
SVC 270D-07D	4.5	9.0	10.0	25	5.0	0.55
SVC 330D-07D	4.5	9.0	10.0	25	5.0	0.55
SVC 390D-07D	4.5	9.0	10.0	25	5.0	0.55
SVC 470D-07D	4.5	9.0	10.0	25	5.0	0.55
SVC 560D-07D	4.5	9.0	10.0	25	5.0	0.55
SVC 680D-07D	4.5	9.0	10.0	25	5.0	0.55
SVC 180D-10B	5.0	13.5	16.5	25	7.5	0.70
SVC 220D-10B	5.0	13.5	16.5	25	7.5	0.70
SVC 270D-10B	5.0	13.5	16.5	25	7.5	0.70
SVC 330D-10B	5.0	13.5	16.5	25	7.5	0.70
SVC 390D-10B	5.0	13.5	16.5	25	7.5	0.70
SVC 470D-10B	5.0	13.5	16.5	25	7.5	0.70
SVC 560D-10B	5.0	13.5	16.5	25	7.5	0.70
SVC 680D-10B	5.0	13.5	16.5	25	7.5	0.70
SVC 180D-14B	5.0	17.0	20.0	25	7.5	0.70
SVC 220D-14B	5.0	17.0	20.0	25	7.5	0.70
SVC 270D-14B	5.0	17.0	20.0	25	7.5	0.70
SVC 330D-14B	5.0	17.0	20.0	25	7.5	0.70
SVC 390D-14B	5.0	17.0	20.0	25	7.5	0.70
SVC 470D-14B	5.0	17.0	20.0	25	7.5	0.70
SVC 560D-14B	5.0	17.0	20.0	25	7.5	0.70
SVC 680D-14B	5.0	17.0	20.0	25	7.5	0.70
SVC 180D-20B	6.0	23.0	27.0	30	10.0	0.07
SVC 220D-20B	6.0	23.0	27.0	30	10.0	0.07
SVC 270D-20B	6.0	23.0	27.0	30	10.0	0.07
SVC 330D-20B	6.0	23.0	27.0	30	10.0	0.07
SVC 390D-20B	6.0	23.0	27.0	30	10.0	0.07
SVC 470D-20B	6.0	23.0	27.0	30	10.0	0.07
SVC 560D-20B	6.0	23.0	27.0	30	10.0	0.07
SVC 680D-20B	6.0	23.0	27.0	30	10.0	0.07

A TYPE

TYPE	Tmax	Dmax	Hmax	Lmin	F	φ d
SVC 820D-05A	4.5	7.0	10.0	25	5.0	0.55
SVC 101D-05A	4.5	7.0	10.0	25	5.0	0.55
SVC 121D-05A	4.5	7.0	10.0	25	5.0	0.55
SVC 151D-05A	4.5	7.0	10.0	25	5.0	0.55
SVC 201D-05A	4.5	7.0	10.0	25	5.0	0.55
SVC 221D-05A	4.5	7.0	10.0	25	5.0	0.55
SVC 241D-05A	4.5	7.0	10.0	25	5.0	0.55
SVC 271D-05A	4.5	7.0	10.0	25	5.0	0.55
SVC 361D-05A	5.0	7.0	10.0	25	5.0	0.55
SVC 391D-05A	5.0	7.0	10.0	25	5.0	0.55
SVC 431D-05A	6.0	7.0	10.0	25	5.0	0.55
SVC 471D-05A	6.0	7.0	10.0	25	5.0	0.55

TYPE	Tmax	Dmax	Hmax	Lmin	F	φ d
SVC 820D-07A	4.5	9.0	12.0	25	5.0	0.55
SVC 101D-07A	4.5	9.0	12.0	25	5.0	0.55
SVC 121D-07A	4.5	9.0	12.0	25	5.0	0.55
SVC 151D-07A	4.5	9.0	12.0	25	5.0	0.55
SVC 201D-07A	4.5	9.0	12.0	25	5.0	0.55
SVC 221D-07A	4.5	9.0	12.0	25	5.0	0.55
SVC 241D-07A	4.5	9.0	12.0	25	5.0	0.55
SVC 271D-07A	4.5	9.0	12.0	25	5.0	0.55
SVC 361D-07A	5.0	9.0	12.0	25	5.0	0.55
SVC 391D-07A	5.0	9.0	12.0	25	5.0	0.55
SVC 431D-07A	6.0	9.0	12.0	25	5.0	0.55
SVC 471D-07A	6.0	9.0	12.0	25	5.0	0.55
SVC 820D-10A	4.5	14.0	17.0	25	7.5	0.70
SVC 101D-10A	4.5	14.0	17.0	25	7.5	0.70
SVC 121D-10A	4.5	14.0	17.0	25	7.5	0.70
SVC 151D-10A	4.5	14.0	17.0	25	7.5	0.70
SVC 201D-10A	4.5	14.0	17.0	25	7.5	0.70
SVC 221D-10A	4.5	14.0	17.0	25	7.5	0.70
SVC 241D-10A	4.5	14.0	17.0	25	7.5	0.70
SVC 271D-10A	4.5	14.0	17.0	25	7.5	0.70
SVC 361D-10A	5.0	14.0	17.0	25	7.5	0.70
SVC 391D-10A	5.0	14.0	17.0	25	7.5	0.70
SVC 431D-10A	6.0	14.0	17.0	25	7.5	0.70
SVC 471D-10A	6.0	14.0	17.0	25	7.5	0.70
SVC 561D-10A	6.0	14.0	17.0	25	7.5	0.70
SVC 621D-10A	7.5	14.0	17.0	25	7.5	0.70
SVC 681D-10A	7.5	14.0	17.0	25	7.5	0.70
SVC 751D-10A	8.5	14.0	17.0	25	7.5	0.70
SVC 781D-10A	8.5	14.0	17.0	25	7.5	0.70
SVC 821D-10A	8.5	14.0	17.0	25	7.5	0.70
SVC 911D-10A	10.5	14.0	17.0	25	7.5	0.70
SVC 102D-10A	10.5	14.0	17.0	25	7.5	0.70
SVC 112D-10A	10.5	14.0	17.0	25	7.5	0.70
SVC 820D-14A	4.5	17.5	21.0	25	7.5	0.70
SVC 911D-14A	4.5	17.5	21.0	25	7.5	0.70
SVC 121D-14A	4.5	17.5	21.0	25	7.5	0.70
SVC 151D-14A	4.5	17.5	21.0	25	7.5	0.70
SVC 201D-14A	4.5	17.5	21.0	25	7.5	0.70
SVC 221D-14A	4.5	17.5	21.0	25	7.5	0.70
SVC 241D-14A	4.5	17.5	21.0	25	7.5	0.70
SVC 271D-14A	4.5	17.5	21.0	25	7.5	0.70
SVC 361D-14A	5.0	17.5	21.0	25	7.5	0.70
SVC 391D-14A	5.0	17.5	21.0	25	7.5	0.70
SVC 431D-14A	6.0	17.5	21.0	25	7.5	0.70
SVC 471D-14A	6.0	17.5	21.0	25	7.5	0.70
SVC 561D-14A	7.5	17.5	21.0	25	7.5	0.70
SVC 621D-14A	7.5	17.5	21.0	25	7.5	0.70
SVC 681D-14A	7.5	17.5	21.0	25	7.5	0.70
SVC 751D-14A	8.5	17.5	21.0	25	7.5	0.70
SVC 781D-14A	8.5	17.5	21.0	25	7.5	0.70
SVC 821D-14A	8.5	17.5	21.0	25	7.5	0.70
SVC 911D-14A	10.5	17.5	21.0	25	7.5	0.70
SVC 102D-14A	10.5	17.5	21.0	25	7.5	0.70
SVC 112D-14A	10.5	17.5	21.0	25	7.5	0.70
SVC 182D-14A	15.0	17.5	21.0	25	7.5	0.70
SVC 820D-20A	4.5	23.0	28.0	30	10.0	0.70
SVC 101D-20A	4.5	23.0	28.0	30	10.0	0.70
SVC 121D-20A	4.5	23.0	28.0	30	10.0	0.70
SVC 151D-20A	4.5	23.0	28.0	30	10.0	0.70
SVC 201D-20A	4.5	23.0	28.0	30	10.0	0.70
SVC 221D-20A	4.5	23.0	28.0	30	10.0	0.70
SVC 241D-20A	4.5	24.0	28.0	30	10.0	0.70
SVC 271D-20A	4.5	24.0	28.0	30	10.0	0.70
SVC 361D-20A	5.0	24.0	28.0	30	10.0	0.70
SVC 391D-20A	5.0	24.0	28.0	30	10.0	0.70
SVC 431D-20A	6.0	24.0	28.0	30	10.0	0.70
SVC 471D-20A	6.0	24.0	28.0	30	10.0	0.70
SVC 561D-20A	7.5	24.0	28.0	30	10.0	0.80
SVC 621D-20A	7.5	24.0	28.0	30	10.0	0.80
SVC 681D-20A	7.5	24.0	28.0	30	10.0	0.80
SVC 751D-20A	8.5	24.0	28.0	30	10.0	0.80
SVC 781D-20A	8.5	24.0	28.0	30	10.0	0.80
SVC 821D-20A	8.5	24.0	28.0	30	10.0	0.80
SVC 911D-20A	10.5	24.0	28.0	30	10.0	0.80
SVC 102D-20A	10.5	24.0	28.0	30	10.0	0.80
SVC 112D-20A	10.0	24.0	28.0	30	10.0	0.80
SVC 182D-20A	15.0	24.0	28.0	30	10.0	0.80

CERAMIC SURGE ABSORBERS (VARISTORS)

SVC

① FS5 Type

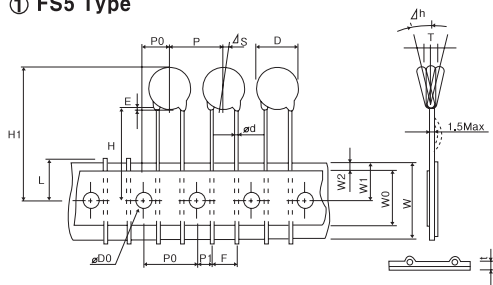

② FK5 Type

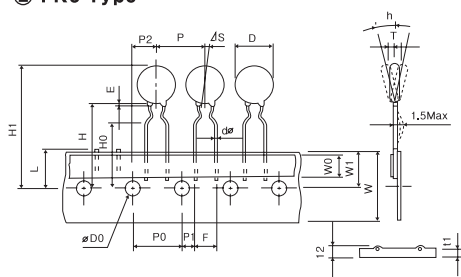

③ FF9 Type

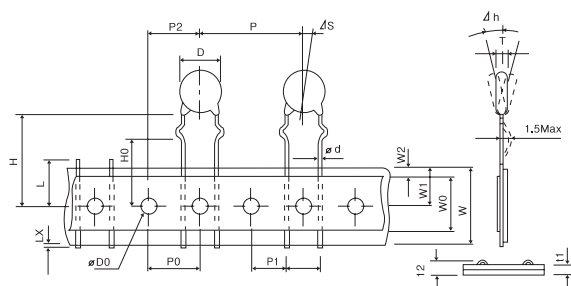

④ FF7 Type

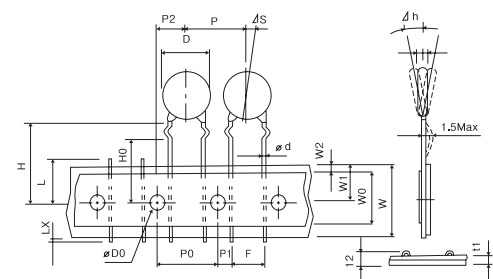

⑤ FF8 Type

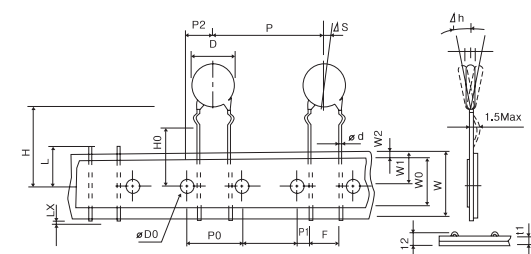

ITEM	Code	Dimensions(mm)	
		FS5, FK5	FF9
Body Diameter	D	See Page 46	
Body thickness	T	See Page 46	
Lead diameter	dφ	0.55±0.05	0.70±0.05
Pitch of sprocket hole	P0	12.7±0.3	
Pitch of component	P	6.35±1.3	25.4±1.0
Lead length from hole center to Lead	P1	3.85±0.7	8.95±1.0
Lead length from hole center to component center	P2	6.35±1.3	12.7±1.5
Lead spacing	F	5.0 ^{+0.8} _{-0.2}	7.5±1.0
Deviation along tape	ΔS	0±1.0	
Deviation across tape	Δh	0±2.0	
Carrier tape width	W	18.0 ^{+1.0} _{-0.5}	
Hold down tape width	W0	5.0min 9.0min	
Position of sprocket hole	W1	9.0±0.5	
Hold down tape position	W2	3.0max	
Lead wire clinch height	H0	16.0±0.5	
Height of component hole	H	20.0 ^{+1.5} _{-1.0}	
Component height	H1	32.25max	
Diameter of sprocket hole	D0	4.0±0.2	
Length of snapped lead	L	11.0max	
Total tape thickness	t1	0.7±0.2	
Total thickness tape and lead wire	t2	1.5max	1.7max
Length of snapped lead	lk	1.0max	

ITEM	Code	Dimensions(mm)	
		FF7	FF8
Body Diameter	D	See Page 46	
Body thickness	T	See Page 46	
Lead diameter	dφ	0.70±0.05	
Pitch of sprocket hole	P0	15.0±0.3	
Pitch of component	P	15.0±1.0	30.0±1.0
Lead length from hole center to Lead	P1	3.75±1.0	
Lead length from hole center to component center	P2	7.50±1.5	
Lead spacing	F	7.5±1.0	
Deviation along tape	ΔS	0±1.0	
Deviation across tape	Δh	0±2.0	
Carrier tape width	W	18.0 ^{+1.0} _{-0.5}	
Hold down tape width	W0	5.0min	
Position of sprocket hole	W1	9.0±0.5	
Hold down tape position	W2	3.0max	
Lead wire clinch height	H0	16.0±0.5	
Height of component hole	H	20.0 ^{+1.5} _{-1.0}	
Component height	H1	40.00max	
Diameter of sprocket hole	D0	4.0±0.2	
Length of snapped lead	L	11.0max	
Total tape thickness	t1	0.7±0.2	
Total thickness tape and lead wire	t2	1.7max	
Length of snapped lead	lk	1.0max	

SVC

CHAR, CURVES AND LIFETIME

■ TRANSIENT V-I CHARACTERISTIC CURVES

Current waveform Under 10^{-2} A : DC
 Over 10^{-1} A : $8/20\mu\text{s}$

• 05B (SVC 180D-05B to SVC680D-05B)

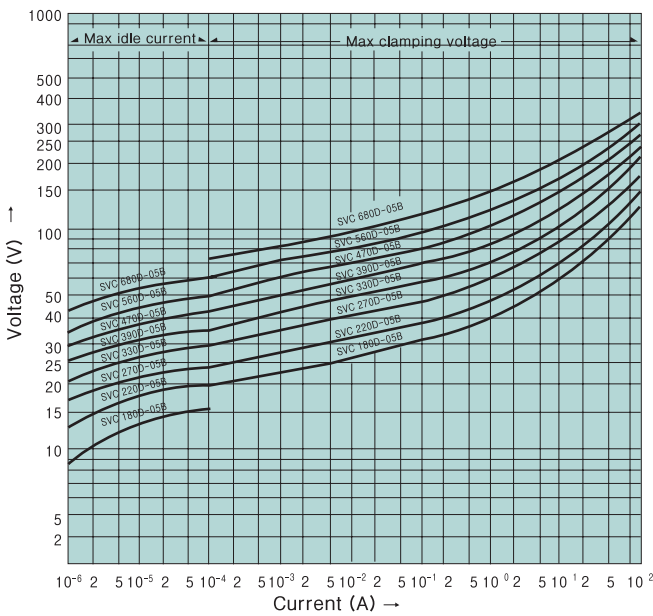

■ PULSE LIFETIME RATINGS

Notes : 2 – pulse : 5 – minute interval
 3 to 10 – pulse : 2 – minute interval
 Up to 10^6 – pulse : 10 – second interval

• 05B (SVC 180D-05B to SVC680D-05B)

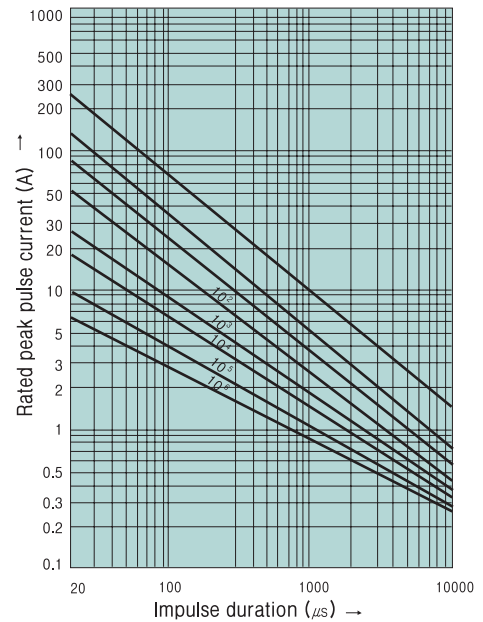

• 05A (SVC 820D-05A to SVC471D-05A)

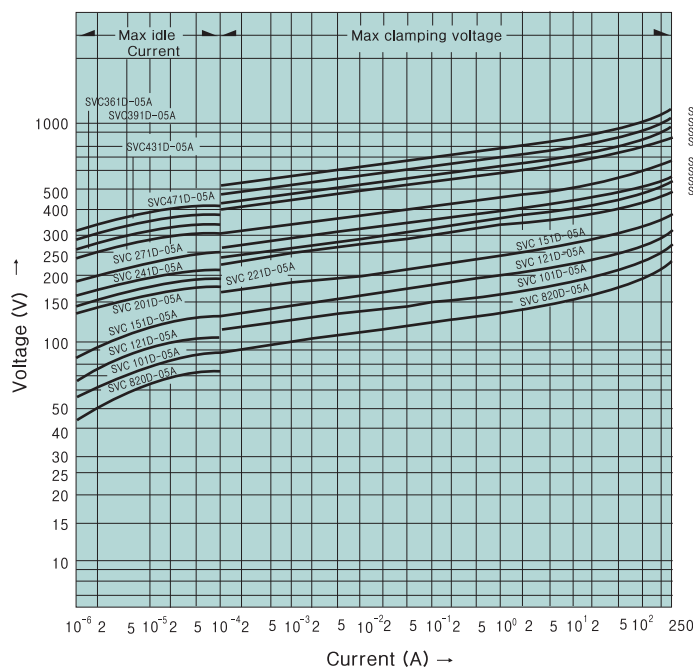

• 05A (SVC 820D-05A to SVC471D-05A)

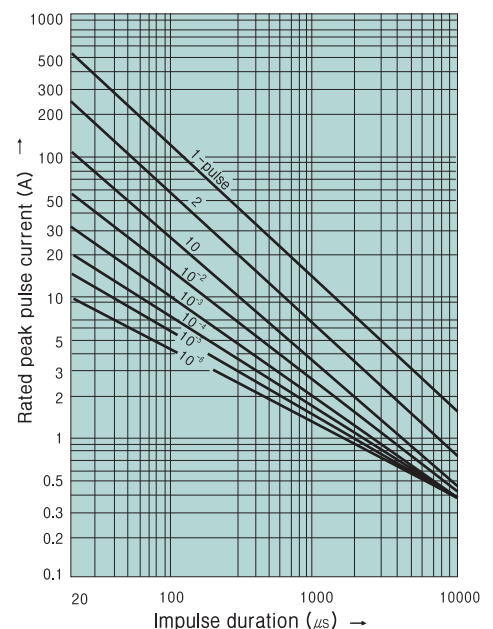

CERAMIC SURGE ABSORBERS (VARISTORS)

SVC

TRANSIENT V-I CHARACTERISTIC CURVES

Current waveform Under 10^{-2} A : DC
 Over 10^{-1} A : $8/20\mu s$

• 07B (SVC 180D-07B to SVC680D-07B)

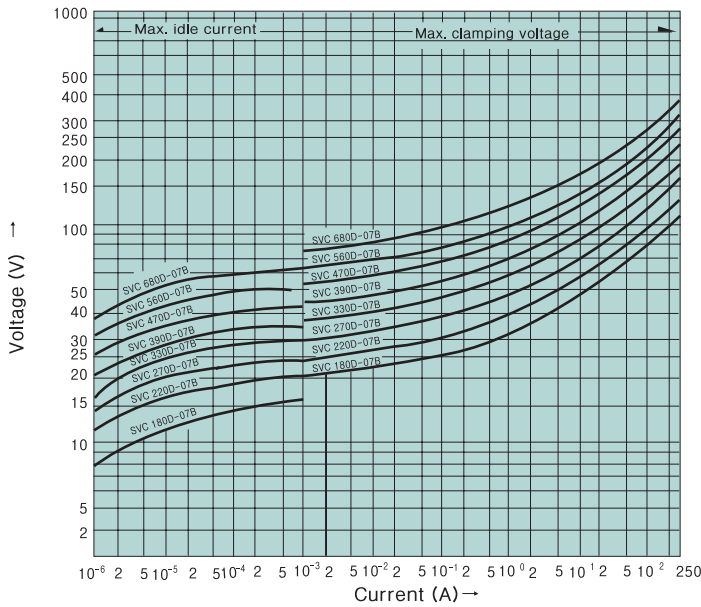

PULSE LIFETIME RATINGS

Notes : 2 - pulse : 5 - minute interval
 3 to 10 - pulse : 2 - minute interval
 Up to 10^6 - pulse : 10 - second interval

• 07B (SVC 180D-07B to SVC680D-07B)

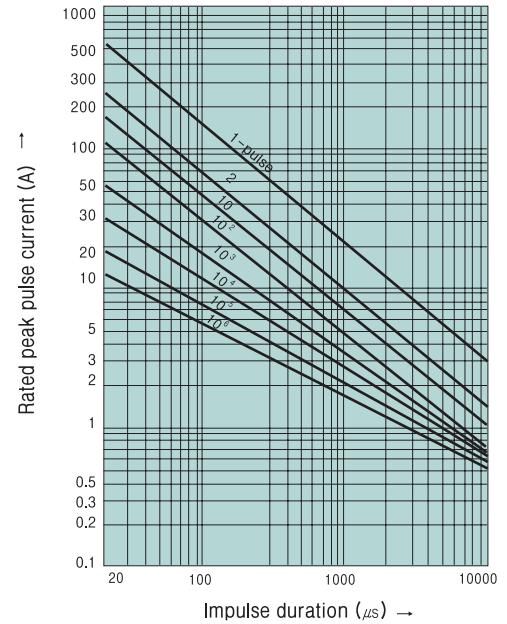

• 07A (SVC 820D-07A to SVC471D-07A)

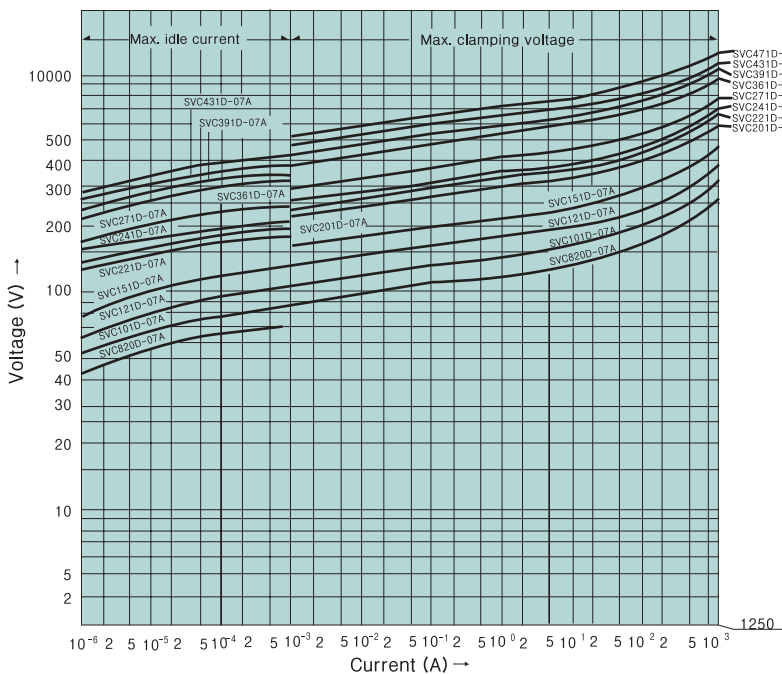

• 07A (SVC 820D-07A to SVC471D-07A)

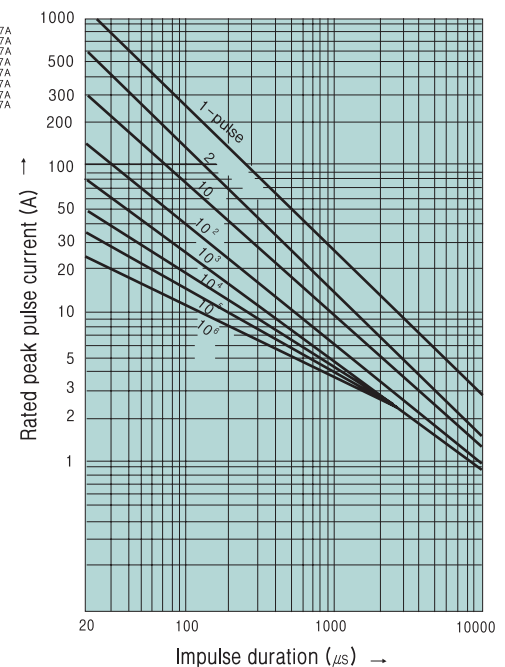

CERAMIC SURGE ABSORBERS (VARISTORS)

SVC

TRANSIENT V-I CHARACTERISTIC CURVES

Current waveform Under 10^{-2} A : DC
 Over 10^{-1} A : 8/20 μ s

• 10B (SVC 180D-10B to SVC680D-10B)

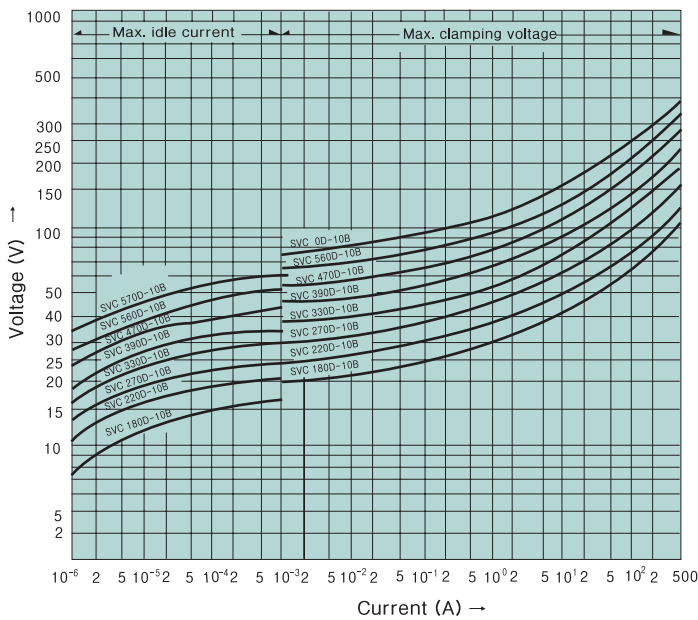

PULSE LIFETIME RATINGS

Notes : 2 - pulse : 5 - minute interval
 3 to 10 - pulse : 2 - minute interval
 Up to 10^6 - pulse : 10 - second interval

• 10B (SVC 180D-10B to SVC680D-10B)

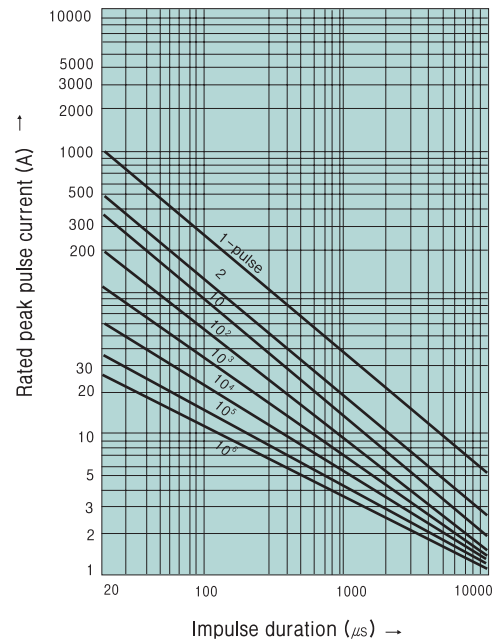

• 10A (SVC 820D-10A to SVC471D-10A)

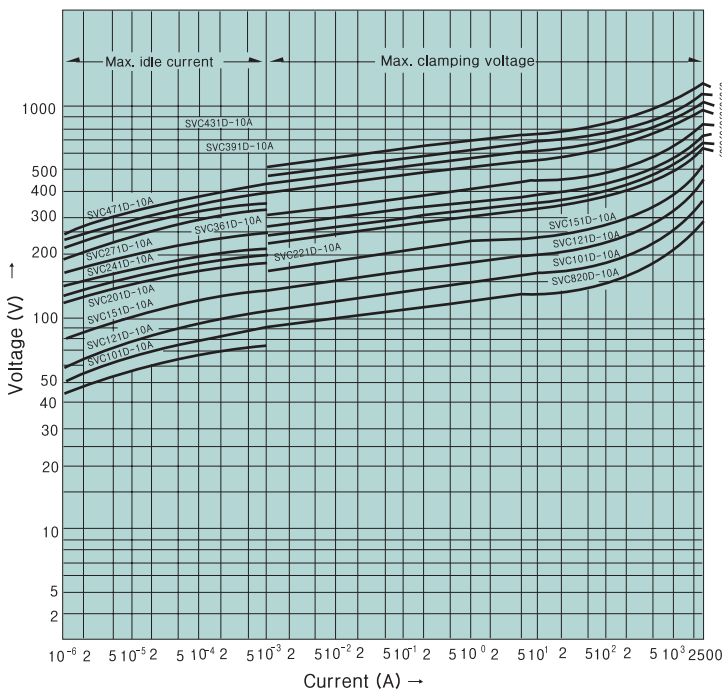

• 10A (SVC 820D-10A to SVC471D-10A)

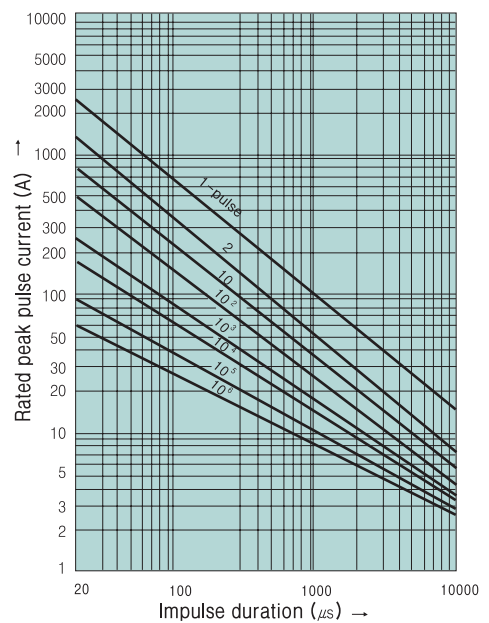

CERAMIC SURGE ABSORBERS (VARISTORS)

SVC

TRANSIENT V-I CHARACTERISTIC CURVES

Current waveform Under 10^{-2} A : DC
Over 10^{-1} A : 8/20 μ s

• 10A (SVC561D-10A to SVC112D-10A)

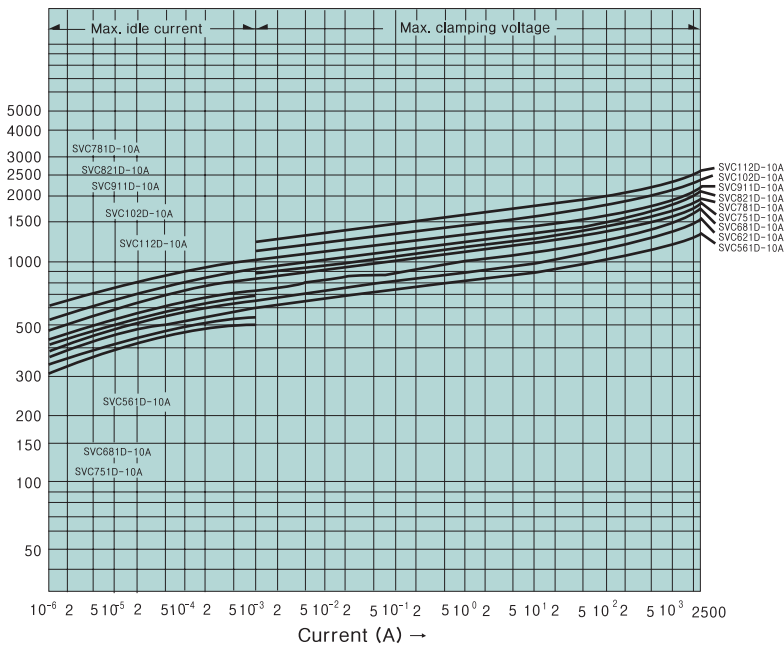

PULSE LIFETIME RATINGS

Notes : 2 - pulse : 5 - minute interval
3 to 10 - pulse : 2 - minute interval
Up to 10^6 - pulse : 10 - second interval

• 10A (SVC 561D-10A to SVC112D-10A)

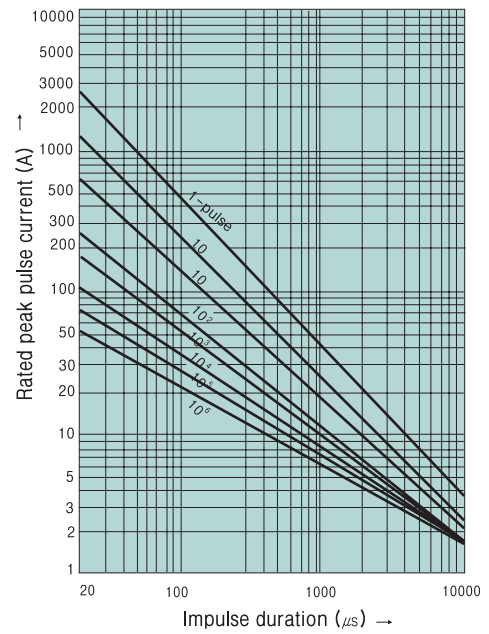

• 14B (SVC 180D-14B to ENC680D-14B)

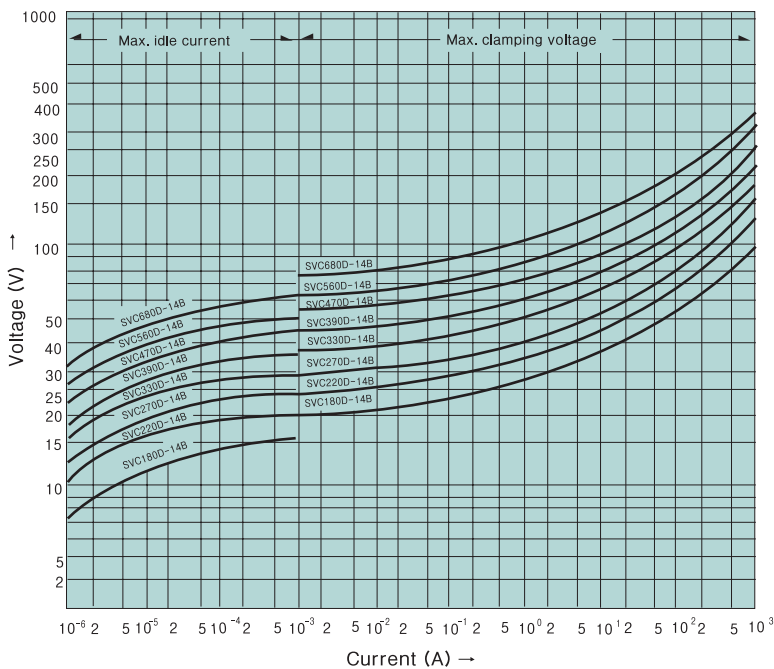

• 14B (SVC 180D-14B to SVC680D-14B)

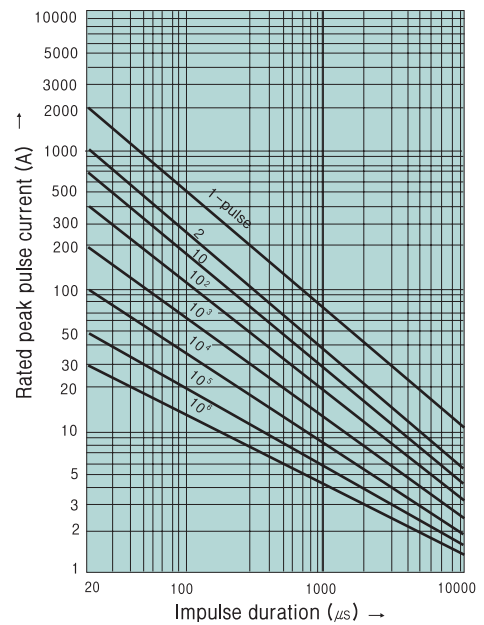

SVC

TRANSIENT V-I CHARACTERISTIC CURVES

Current waveform Under 10^{-2} A : DC
 Over 10^{-1} A : 8/20 μ s

• 14A (SVC 820D-14A to SVC471D-14A)

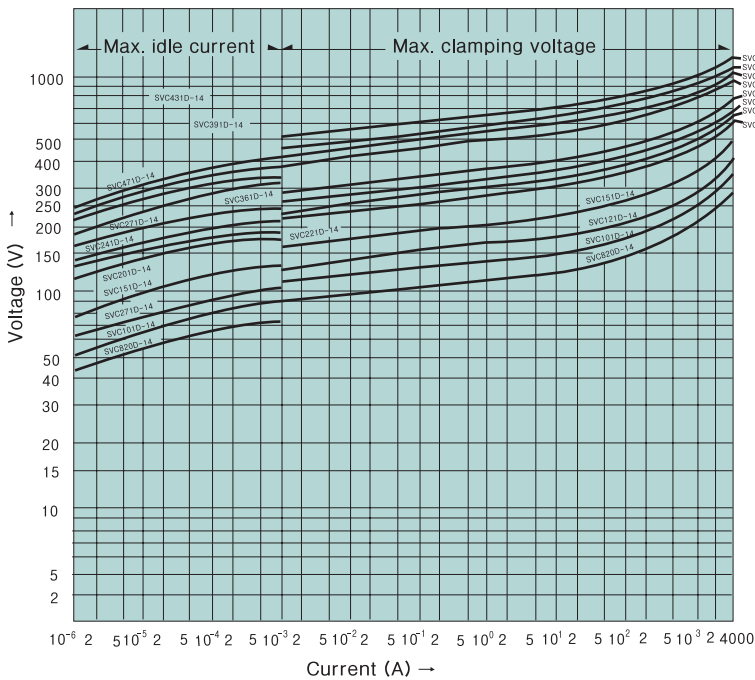

PULSE LIFETIME RATINGS

Notes : 2 - pulse : 5 - minute interval
 3 to 10 - pulse : 2 - minute interval
 Up to 10^6 - pulse : 10 - second interval

• 14A (SVC 820D-14A to SVC471D-14A)

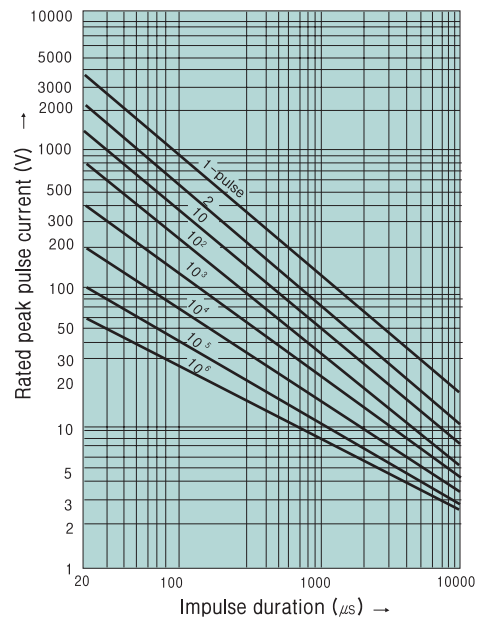

• 14A (SVC 561D-14A to SVC182D-14A)

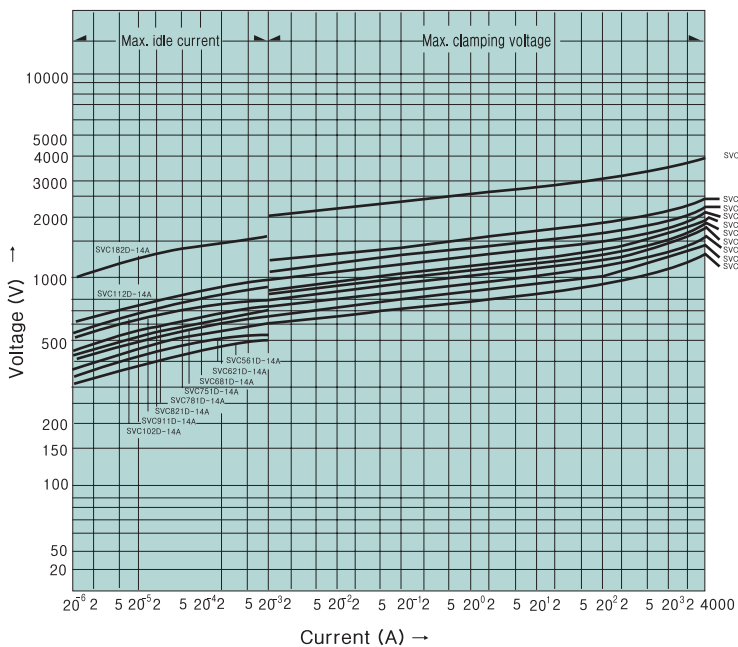

• 14A (SVC 561D-14A to SVC182D-14A)

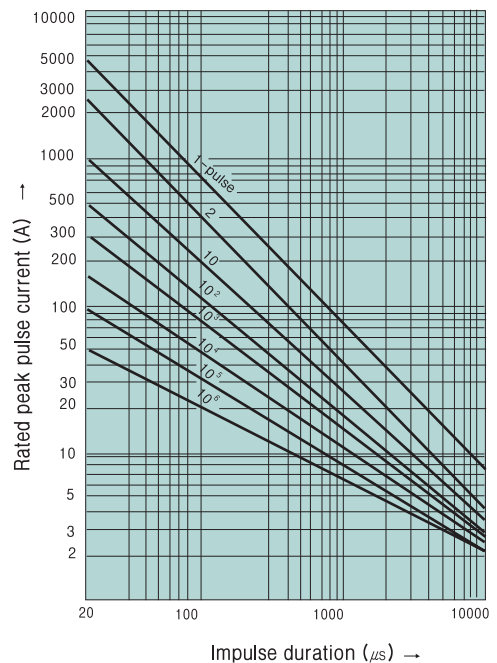

CERAMIC SURGE ABSORBERS (VARISTORS)

SVC

TRANSIENT V-I CHARACTERISTIC CURVES

Current waveform Under 10^{-2} A : DC
 Over 10^{-1} A : 8/20 μ s

• 20B (SVC180D-20B to SVC680D-20B)

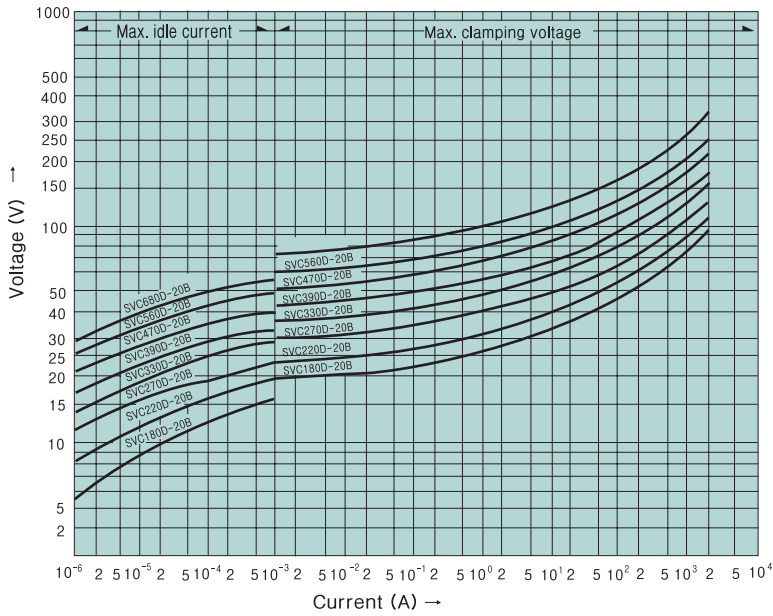

PULSE LIFETIME RATINGS

Notes : 2 - pulse : 5 - minute interval
 3 to 10 - pulse : 2 - minute interval
 Up to 10^6 - pulse : 10 - second interval

• 20B (SVC180D-20B to SVC680D-20B)

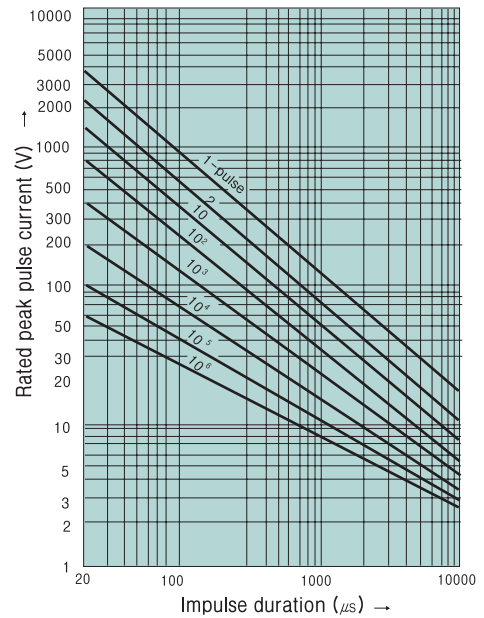

• 20A (SVC 820D-20A to SVC471D-20A)

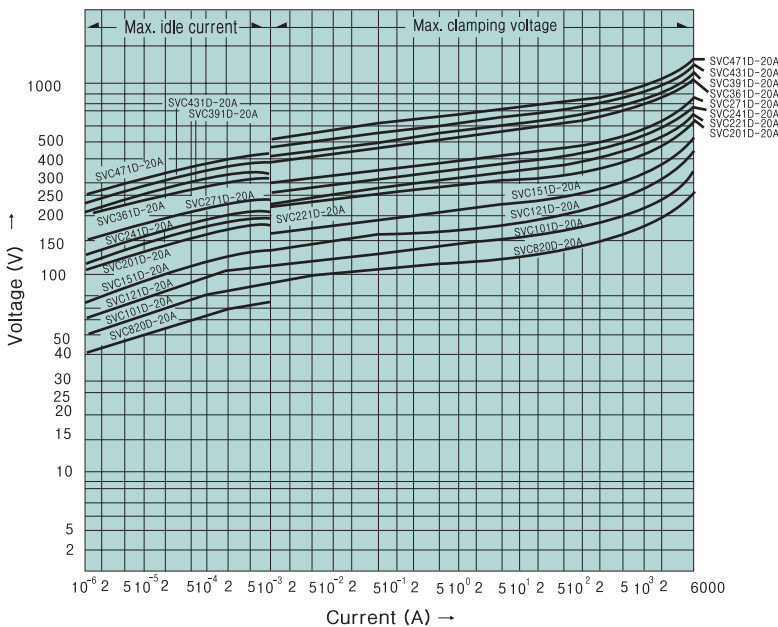

• 20A (SVC 820D-20A to SVC471D-20A)

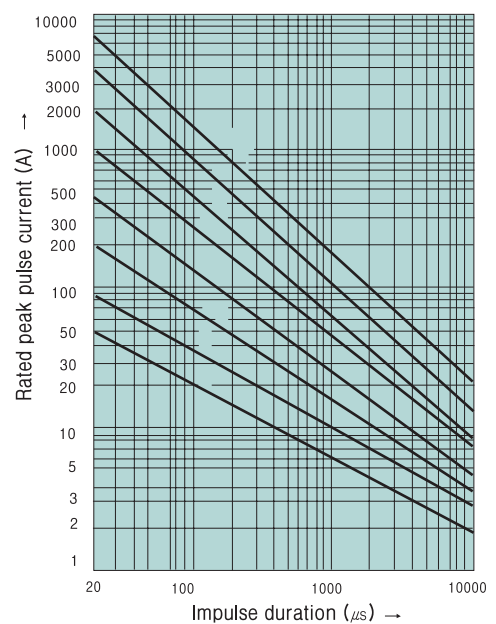

SVC

TRANSIENT V-I CHARACTERISTIC CURVES

Current waveform Under 10^{-2} A : DC
 Over 10^{-1} A : 8/20 μ s

• 20A (SVC 561D-20A to SVC182D-20A)

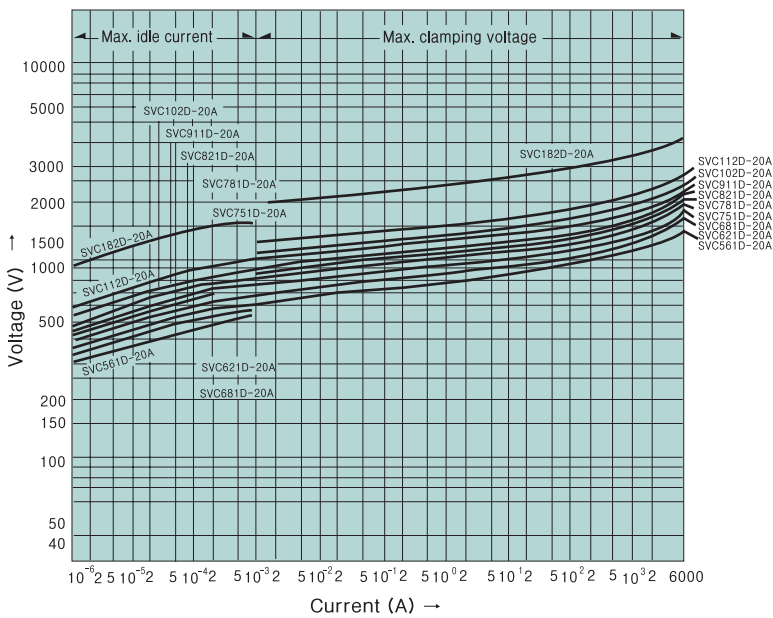

PULSE LIFETIME RATINGS

Notes : 2 - pulse : 5 - minute interval
 3 to 10 - pulse : 2 -minute interval
 Up to 10^6 - pulse : 10 - second interval

• 20A (SVC 561D-20A to SVC182D-20A)

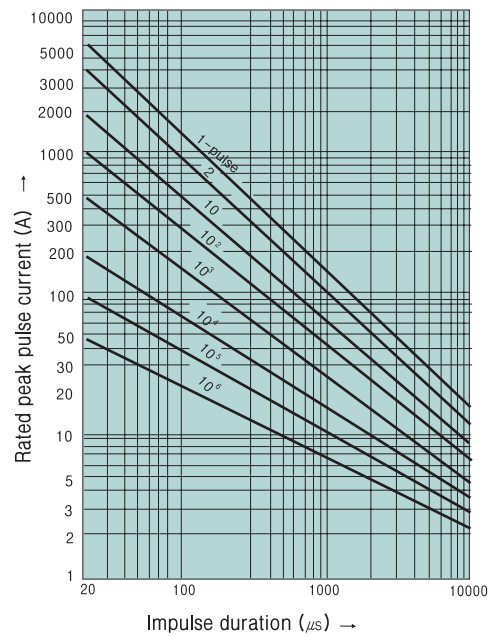

CERAMIC SURGE ABSORBERS (VARISTORS)

SVC

APPLICATIONS

- The protection of semiconducting elements such as diodes, thyristors, transistors, IC and relays against transient voltages.
- Similar protection of many types of measuring instruments, control machinery and communication equipment and broadcasting equipment against inductive lightning and switching surges.
- Protection of general purpose electrical equipment, domestic machinery and appliances. TV and radios and similar consumer products against lightning and switching surges.

Power supply circuit protection

Line circuit

Varistor voltage selection table (Z_L)

Power supply voltage	Type
100V AC	SVC201D-□□A SVC221D-□□A SVC241D-□□A SVC271D-□□A*
200V AC	SVC391D-□□A SVC431D-□□A SVC471D-□□A*
12V DC	SVC220D-□□B
24V DC	SVC390D-□□B

Notes :

- ①The power supply voltage must not exceed the maximum allowable circuit voltage.
- ②Since independent wiring loads and capacitive loads cause the voltage build-up at the time of opening or closing the load, use SVC having a varistor voltage as high as possible. (* mark)
- ③The bold faced portions of the type letters vary.

AC/DC single-phase circuit

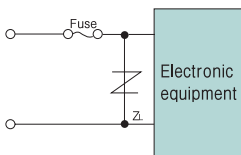

AC three-phase circuit

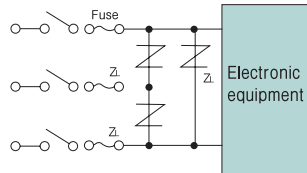

Line and ground circuit

Varistor voltage selection table (Z_E)

Power supply voltage	Type
100V AC	SVC431D-□□A
200V AC	SVC471D-□□A SVC751D-□□A to SVC 112D-□□A* SVC182D-□□A**

Notes :

- ①When subjected to megger testing (500V DC), the insulation resistance value can decrease due to the leakage current of the SVC. To avoid this remove the varistor or use * marked SVC.
 - ②When subjected to dielectric strength test(1000V AC). remove the SVC or use** marked SVC.
- Select varistors taking a note of operating conditions peculiar to the equipment.

AC/DC single-phase circuit

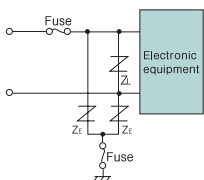

AC three-phase circuit

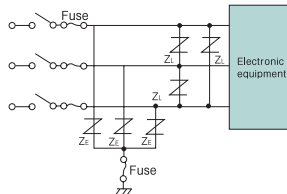

Telecommunication circuit protection

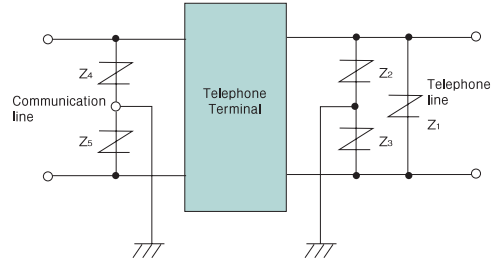

Varistor voltage selection guided

Power supply voltage	Type
12V DC	SVC180D-□□B SVC220D-□□B SVC820D-□□A
24V AC	SVC390D-□□B SVC820D-□□A

Notes :

The varistor SVC has a capacitance value. Take note of this when applying them to high-frequency signal circuits.

Switching circuit protection

Protection of relay (Contact coil)

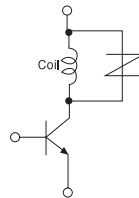

Protection of semiconductors

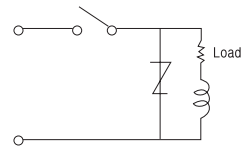
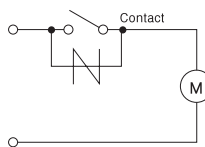
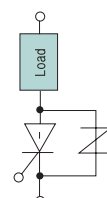

Varistor voltage selection guide

Power supply voltage	Type
12V DC	SVC220D-□□B
24V DC	SVC390D-□□B
100V DC	SVC151D-□□A
100V AC	SVC201D-□□A SVC221D-□□A SVC241D-□□A SVC271D-□□A

Notes :

- ①The power supply voltage must not exceed the maximum allowable circuit voltage of the SVC
- ②Pay due attention to the surge energy generated by the load.
- ③Select SVC referring to the pulse lifetime rating.
- ④To further reduce the tendency of sparking across the contacts connect a capacitor parallel with the SVC. This will also protect the equipment from electromagnetic wave jamming.

SVC

Application notes

1. Overcurrent protection

When surges exceed the rating for the SVC, short-circuits or damages can be expected. Take following precautions.

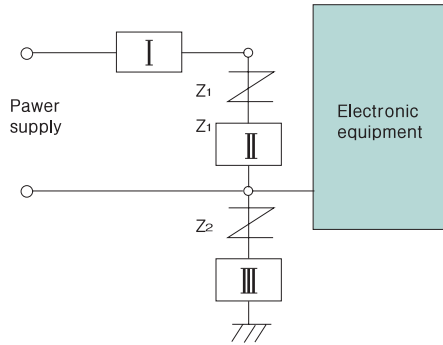

① Connect the SVC at a position nearer to the equipment than the overcurrent protection device “I” (fuse, MCCB) as is shown in the diagram.

When the SVC is shorted, the overcurrent protection device “I” operates (trips or blow off the fuse).

② If the overcurrent protection device “I” can not be installed in “I” position, connect a fuse at “II” position. Select fuse rated current for the SVC referring to the following table.

SVC	05A 05B	07A 07B	10A 10B	14A 14B	20A 20B
Applicable fuse rated current(A)	1 to 2	2 to 3	3 to 5	3 to 10	5 to 15

③ When “Z₂” SVC is connected between the equipment and ground install an ELCB (Earth Leakage Circuit Breaker). If not possible, connect a fuse or thermal fuse at “III” position.

2. Installation

① When operated at location near heating element or exposed to direct sun light, confirm that the the ambient temperature range.

② When operated in dusty or dirty locations, or exposed to corrosive atmospheres, or where metallic powders or salt can be expected, be sure to mount within a protective enclosure.

3. Molding

When shielding the SVC in a resin molding, take a note of the materials used and temperature, since they influence the reliability. For further information please contact SAMWHA

4. Current, power and energy rating vs, temperature

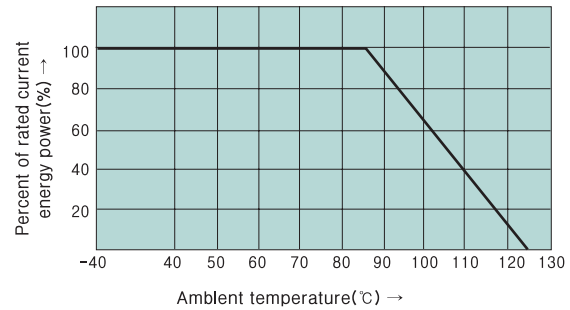

5. Electrical Characteristics

Operating ambient temperature	-40°C to + 85°C
Storage temperature	-40°C to + 125°C
Voltage temperature coefficient	-0.05%/°C
Insulation resistance(at500V)	Over 1000MΩ

Recognized standards

Standard	Date	Content	Applicable SVC series		File No.	
UL	UL 1449	93.03.03	Transient Voltage surge suppressors	Cord connected and Direct Plug in Type Equipment	05Series 07Series 10Series 14Series 20Series	E151195
				Permanently connected type equipment	10Series 14Series 20Series	
	UL 1414	88.05.10	Across-The-Line Components	125V AC	SVC 201D - □A ~SVC 391D - □A	E97754
			250V AC	SVC 391D - □A ~SVC 182D - □A		
	UL 497B	93.07.06	Protectors for data communication and fire alarm circuit	SVC 180D - □~SVC 821D - □		E154171
CAS	C22.2 NO.1-M 1981	93.07.27	Varistor for Across-The-Line use as transient protection on 120Vac system	125V AC	SVC 201D - □A ~SVC 182D - □A	LR78923
ISO 9002	94.12.15					KRQ-007/94

SVC

APPLICATION EXAMPEL

Fire alarm system

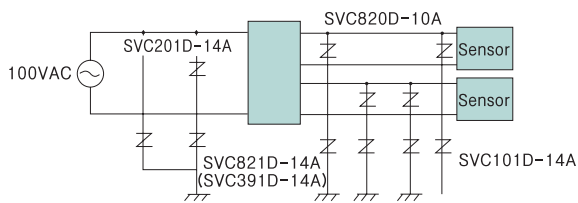

Stove, Boiler

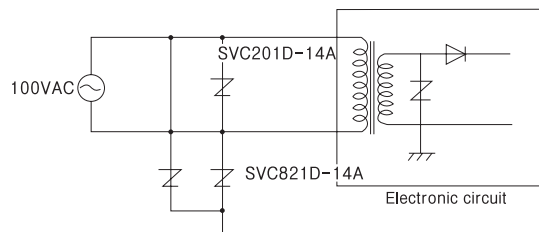

Traffic signal control

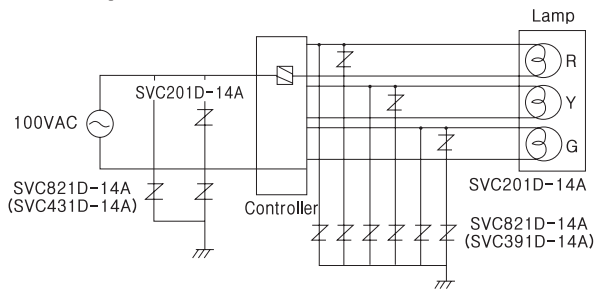

Vending machine

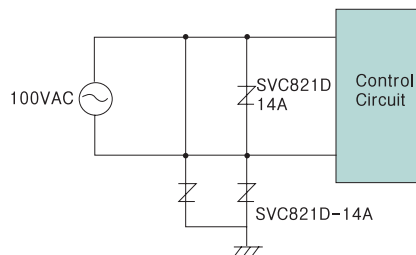

Solenoid

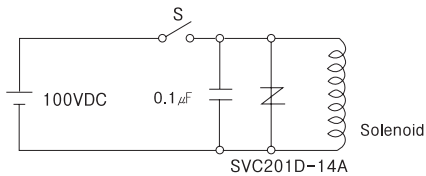

Brake, Clutch

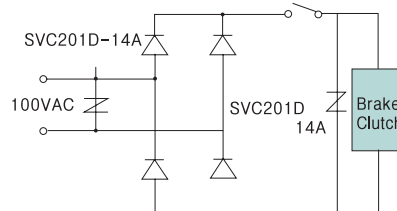

Contact protection

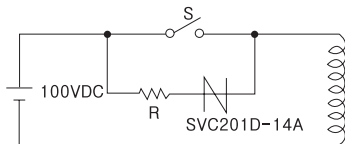

Microwave oven

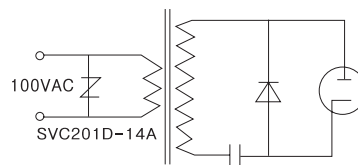

Thyristor protection

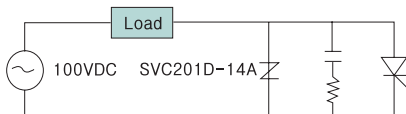

Triac protection

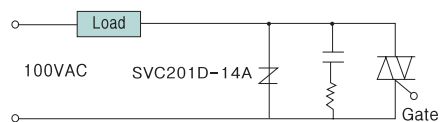

TV booster

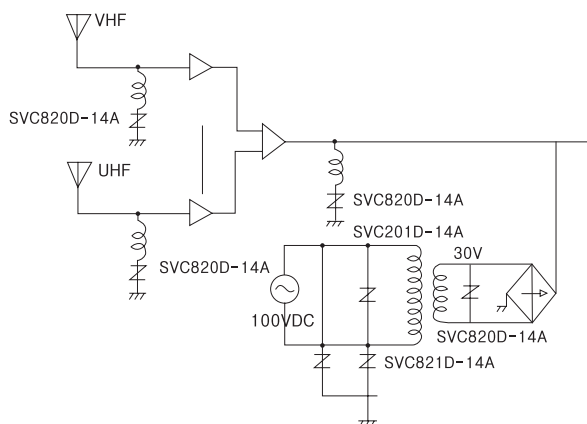

Sound output circuit

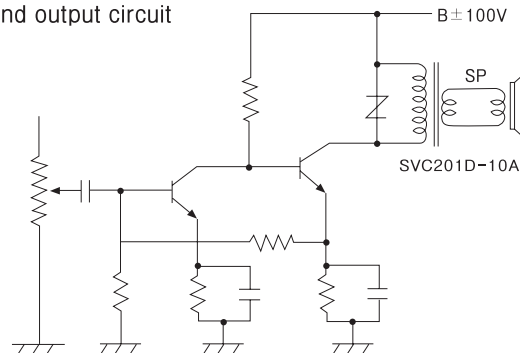

SVC

Varistor Terminology

• **Varistor Voltage : V_{nom}**

Varistor peak terminal voltage measured with a specified current applied
The DC current applied is 1mA normally.

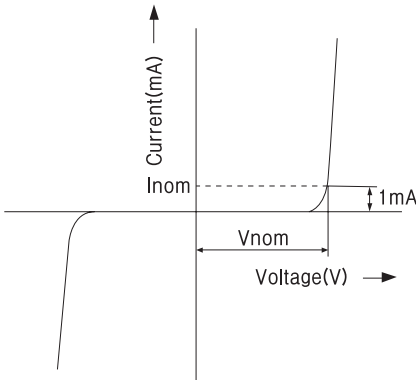

• **Clamping voltage : V_c**

Maximum terminal voltage (peak voltage across the varistor) measured with an applied 8/20 μ s impulse of a given peak current.

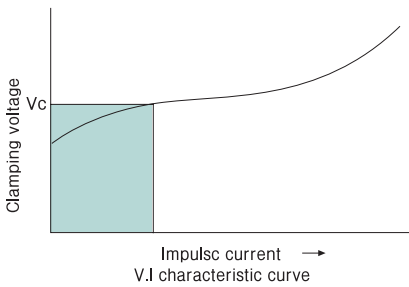

• **Capacitance**

Typical values measured at a test frequency of 1kHz

• **Rated peak transient current : i_{tm}**

Maximum peak current through the varistor with line voltage applied.
The maximum peak current with in the varistor voltage change ratio of $\pm 10\%$ with the standard 8/20 μ s impulse current applied two times at 5 minute interval.

• **Rated transient energy : W_{tm}**

Maximum allowable energy for a single impulse of 2ms square-wave current waveform with rated continuous voltage applied. Maximum energy rating base on a shift of V_{nom} of less than $\pm 10\%$ of initial value.

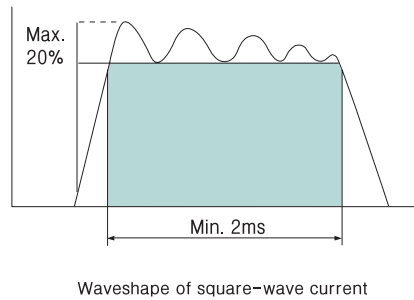

• **Pulse lifetime rating**

This is expressed as the maximum allowable number of impulse currents applied.
8/20 μ s impulse current (or 2ms square wave) is applied at prescribed interval.
This curve also provides for derating current as required with repetitive pulsing.

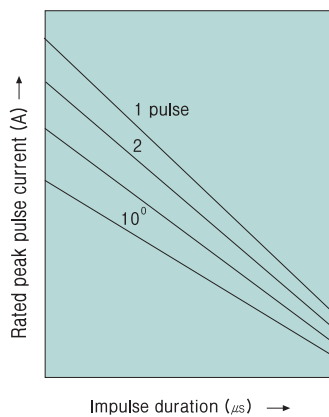

• **Tset current waveform**

Characteristics tests for Varistors are carried out by using 8/20 μ s test impulses. Data such as the maximum clamping voltage (V_c) and the transient peak current (i_{tm}) are obtained by using this impulse current.

However, for the V_c characteristics of the Axial package type a 10mA DC squarewave current is used to carry out the test.

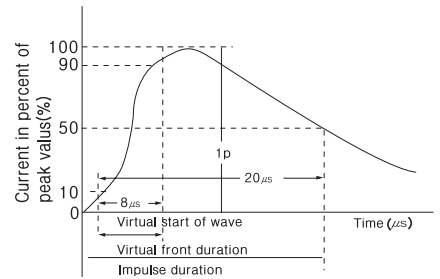

• **Rated RMS Voltage : V_{acm}**

Maximum continuous sinusoidal RMS voltage at 50/60Hz which may be applied.

• **Rated DC Voltage : V_{dcm}**

Maximum continuous DC voltage which may be applied.

• **Rated average power dissipation : P_{tam}**

Maximum average power that can be applied within the specified ambient temperature.