

## N-channel MOSFET

### Features

- High ruggedness
- $R_{DS(ON)}$  (Max 4.5  $\Omega$ ) @  $V_{GS}=10V$
- Gate Charge (Typ 26nC)
- Improved dv/dt Capability
- 100% Avalanche Tested

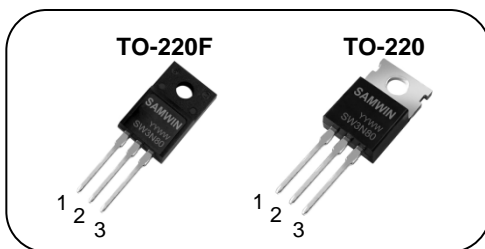

1. Gate 2. Drain 3. Source

$BV_{DSS}$  : 800V  
 $I_D$  : 3.0A  
 $R_{DS(ON)}$  : 4.5ohm

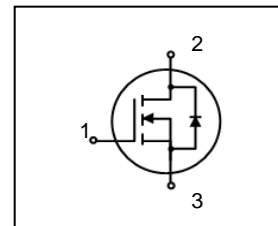

### General Description

This power MOSFET is produced with advanced VDMOS technology of SAMWIN. This technology enable power MOSFET to have better characteristics, such as fast switching time, low on resistance, low gate charge and especially excellent avalanche characteristics. This power MOSFET is usually used at high efficient DC to DC converter block and switch mode power supply.

### Order Codes

Item	Sales Type	Marking	Package	Packaging
1	SW P 3N80	SW3N80	TO-220	TUBE
2	SW F 3N80	SW3N80	TO-220F	TUBE

### Absolute maximum ratings

Symbol	Parameter	Value		Unit
		TO-220	TO-220F	
$V_{DSS}$	Drain to Source Voltage	800		V
$I_D$	Continuous Drain Current (@ $T_C=25^\circ C$ )	3.0	3.0*	A
	Continuous Drain Current (@ $T_C=100^\circ C$ )	1.9	1.9*	A
$I_{DM}$	Drain current pulsed (note 1)	12		A
$V_{GS}$	Gate to Source Voltage	$\pm 30$		V
$E_{AS}$	Single pulsed Avalanche Energy (note 2)	310		mJ
$E_{AR}$	Repetitive Avalanche Energy (note 1)	10		mJ
dv/dt	Peak diode Recovery dv/dt (note 3)	4.5		V/ns
$P_D$	Total power dissipation (@ $T_C=25^\circ C$ )	106	39*	W
	Derating Factor above 25°C	0.8	0.31	W/°C
$T_{STG}, T_J$	Operating Junction Temperature & Storage Temperature	-55 ~ + 150		°C
$T_L$	Maximum Lead Temperature for soldering purpose, 1/8 from Case for 5 seconds.	300		°C

\*. Drain current is limited by junction temperature.

### Thermal characteristics

Symbol	Parameter	Value		Unit
		TO-220	TO-220F	
$R_{thjc}$	Thermal resistance, Junction to case	1.18	3.18	°C/W
$R_{thcs}$	Thermal resistance, Case to Sink	0.5		°C/W
$R_{thja}$	Thermal resistance, Junction to ambient	62.5		°C/W

### Electrical characteristic ( $T_C = 25^\circ\text{C}$ unless otherwise specified )

Symbol	Parameter	Test conditions	Min.	Typ.	Max.	Unit
<b>Off characteristics</b>						
$BV_{DSS}$	Drain to source breakdown voltage	$V_{GS}=0V, I_D=250\mu A$	800	-	-	V
$\Delta BV_{DSS} / \Delta T_J$	Breakdown voltage temperature coefficient	$I_D=250\mu A$ , referenced to $25^\circ\text{C}$	-	1.0	-	V/ $^\circ\text{C}$
$I_{DSS}$	Drain to source leakage current	$V_{DS}=800V, V_{GS}=0V$	-	-	1	$\mu A$
		$V_{DS}=640V, T_C=125^\circ\text{C}$	-	-	20	$\mu A$
$I_{GSS}$	Gate to source leakage current, forward	$V_{GS}=30V, V_{DS}=0V$	-	-	100	nA
	Gate to source leakage current, reverse	$V_{GS}=-30V, V_{DS}=0V$	-	-	-100	nA
<b>On characteristics</b>						
$V_{GS(TH)}$	Gate threshold voltage	$V_{DS}=V_{GS}, I_D=250\mu A$	3.0	-	5.0	V
$R_{DS(ON)}$	Drain to source on state resistance	$V_{GS}=10V, I_D = 1.5A$		3.8	4.5	$\Omega$
<b>Dynamic characteristics</b>						
$C_{iss}$	Input capacitance	$V_{GS}=0V, V_{DS}=25V, f=1\text{MHz}$		540	700	pF
$C_{oss}$	Output capacitance			55	70	
$C_{riss}$	Reverse transfer capacitance			6	7.5	
$t_{d(on)}$	Turn on delay time	$V_{DS}=400V, I_D=3.0A, R_G=25\Omega$		20	40	ns
$t_r$	Rising time			28	95	
$t_{d(off)}$	Turn off delay time			45	55	
$t_f$	Fall time			48	75	
$Q_g$	Total gate charge	$V_{DS}=640V, V_{GS}=10V, I_D=3.0A$		26	35	nC
$Q_{gs}$	Gate-source charge			3.5		
$Q_{gd}$	Gate-drain charge			8.0		

### Source to drain diode ratings characteristics

Symbol	Parameter	Test conditions	Min.	Typ.	Max.	Unit
$I_S$	Continuous source current	Integral reverse p-n Junction diode in the MOSFET	-	-	3	A
$I_{SM}$	Pulsed source current		-	-	12	A
$V_{SD}$	Diode forward voltage drop.	$I_S=3.0A, V_{GS}=0V$	-	-	1.4	V
$T_{rr}$	Reverse recovery time	$I_S=3.0A, V_{GS}=0V,$	-	640	-	ns
$Q_{rr}$	Breakdown voltage temperature	$di_f/dt=100A/\mu s$	-	4.0	-	$\mu C$

#### ※. Notes

1. Repeative rating : pulse width limited by junction temperature.
2.  $L = 67\text{mH}, I_{AS} = 3.0A, V_{DD} = 50V, R_G=25\Omega$ , Starting  $T_J = 25^\circ\text{C}$
3.  $I_{SD} \leq 3.0A, di/dt = 200A/\mu s, V_{DD} \leq BV_{DSS}$ , Starting  $T_J = 25^\circ\text{C}$
4. Pulse Test : Pulse Width  $\leq 300\mu s$ , duty cycle  $\leq 2\%$
5. Essentially independent of operating temperature.

**Fig. 1. On-state characteristics**

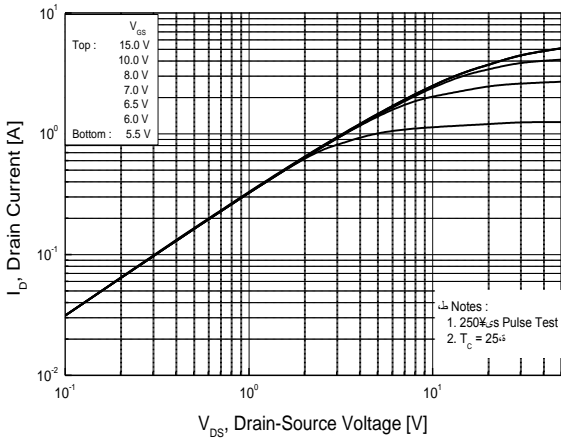

**Fig. 2. Transfer characteristics**

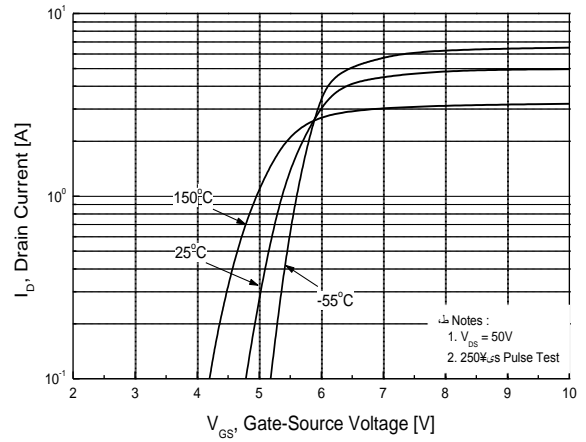

**Fig. 3. On-resistance variation vs. drain current and gate voltage**

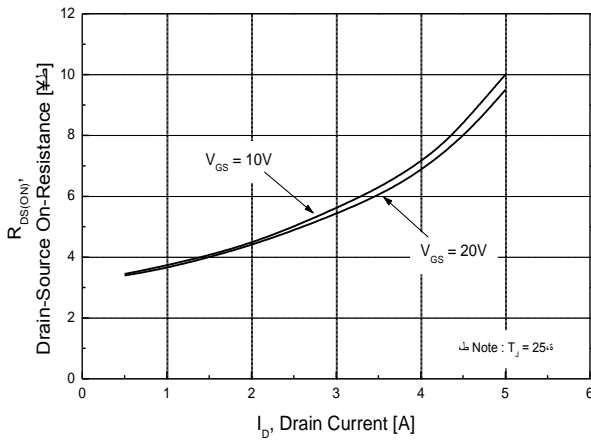

**Fig. 4. On state current vs. diode forward voltage**

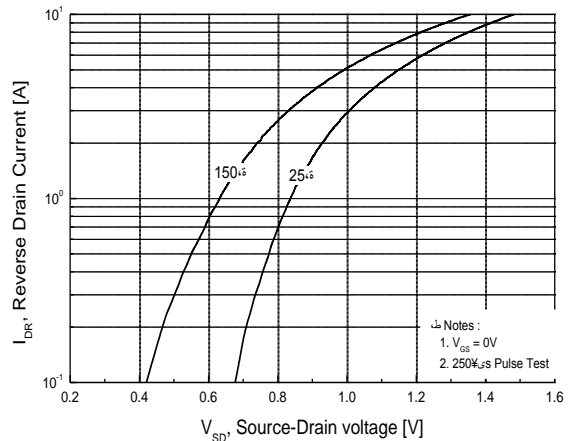

**Fig. 5. Capacitance characteristics (Non-Repetitive)**

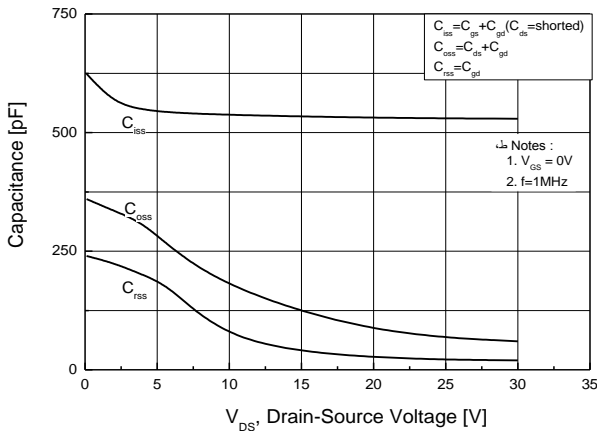

**Fig. 6. Gate charge characteristics**

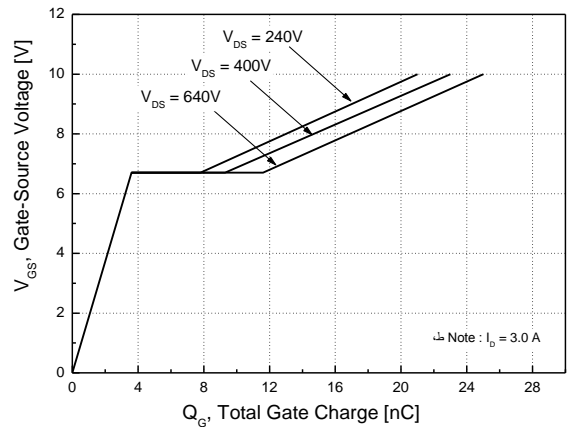

**Fig 7. Breakdown Voltage Variation vs. Junction Temperature**

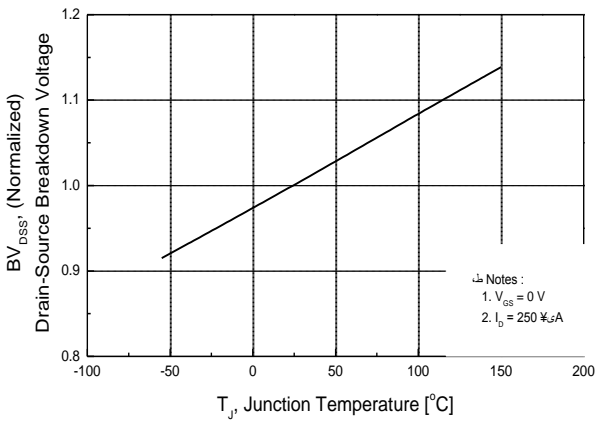

**Fig. 8. On resistance variation vs. junction temperature**

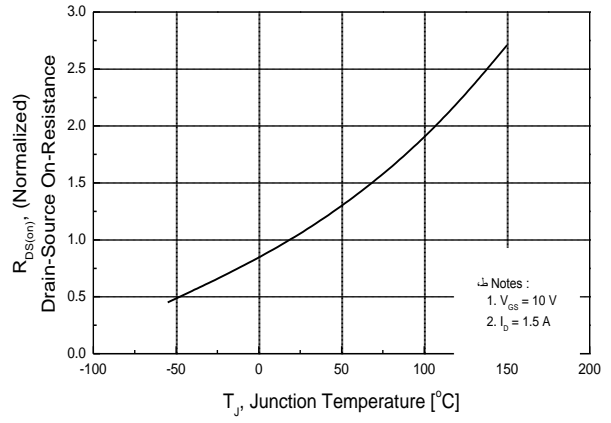

**Fig. 9. Maximum drain current vs. case temperature.**

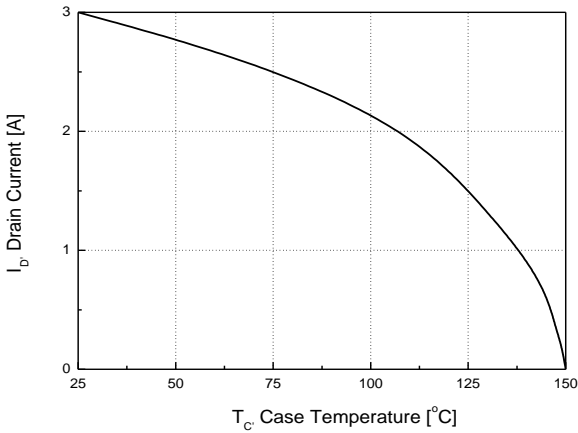

**Fig. 10. Maximum safe operating area**

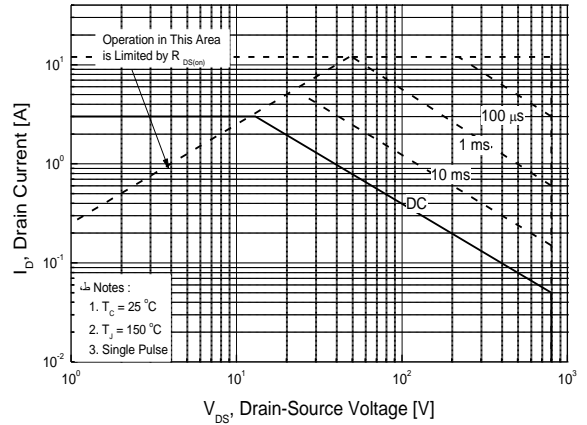

**Fig. 11. Transient thermal response curve**

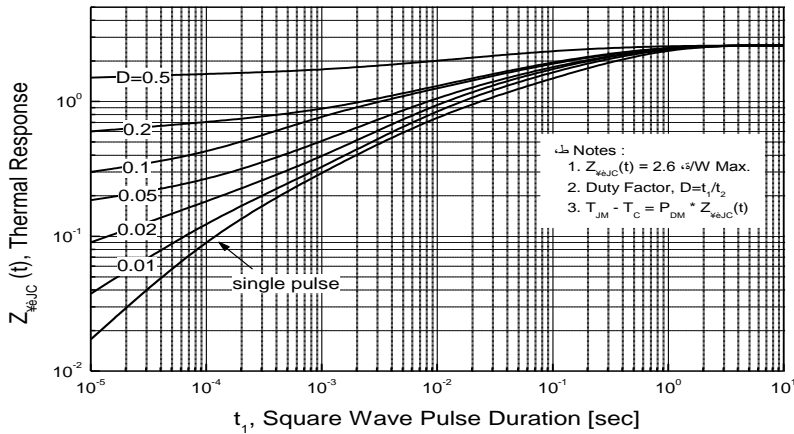

**Fig. 12. Gate charge test circuit & waveform**

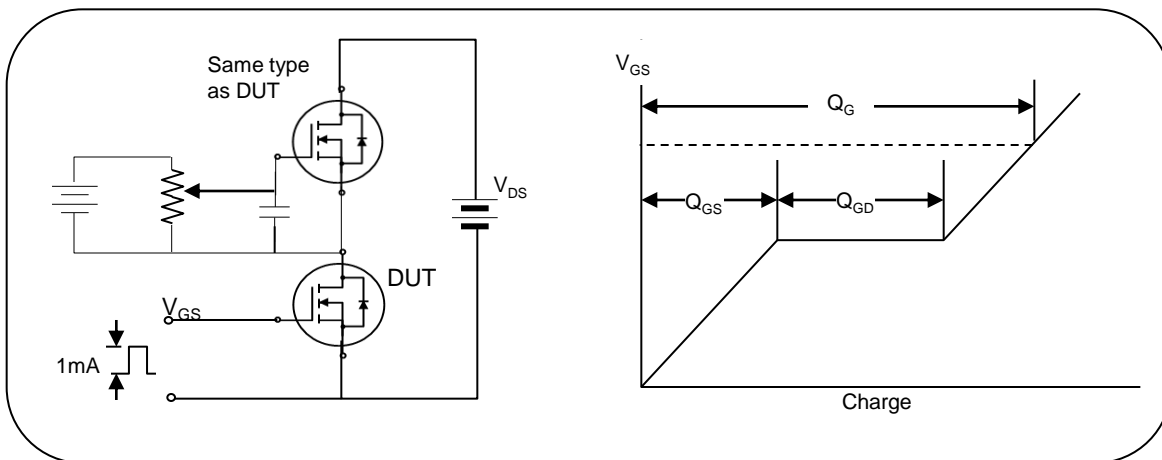

**Fig. 13. Switching time test circuit & waveform**

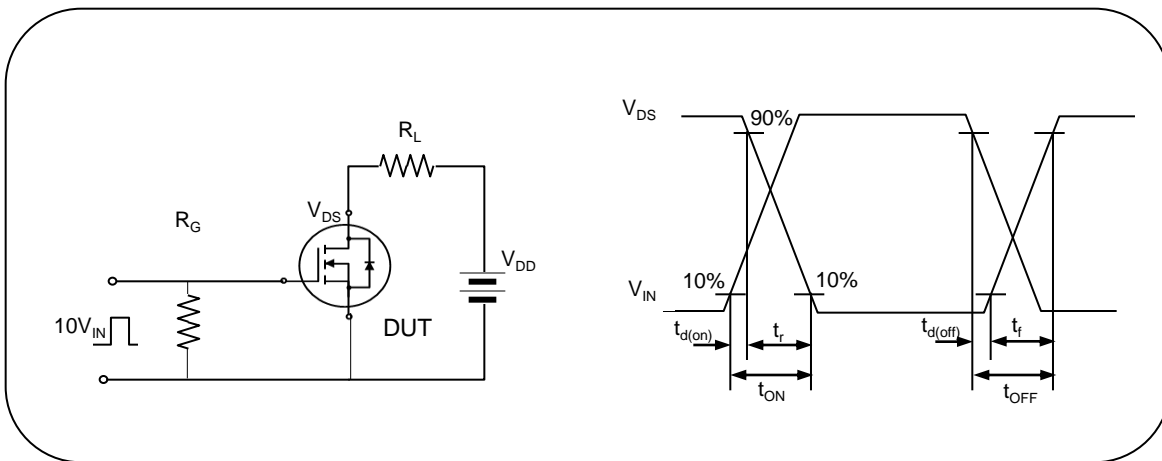

**Fig. 14. Unclamped Inductive switching test circuit & waveform**

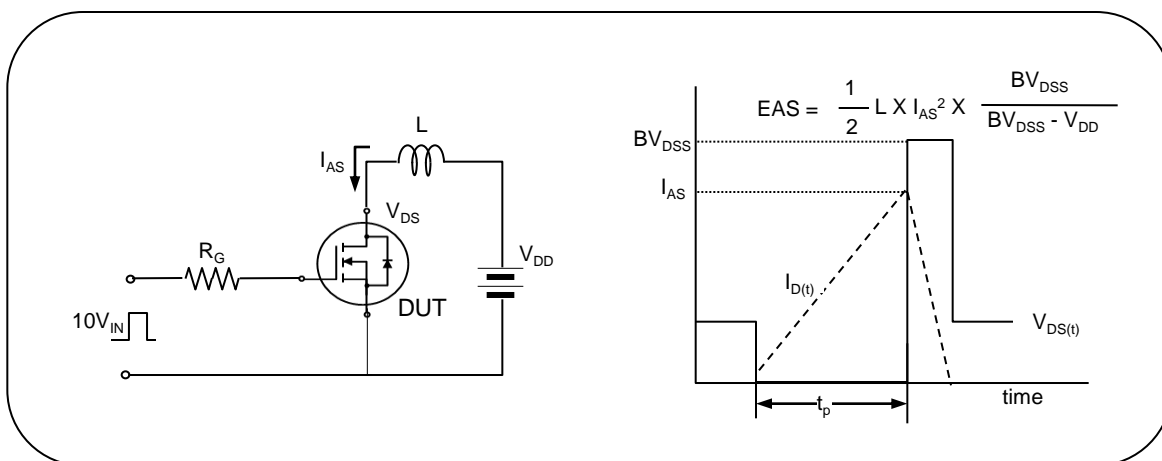

**Fig. 15. Peak diode recovery dv/dt test circuit & waveform**

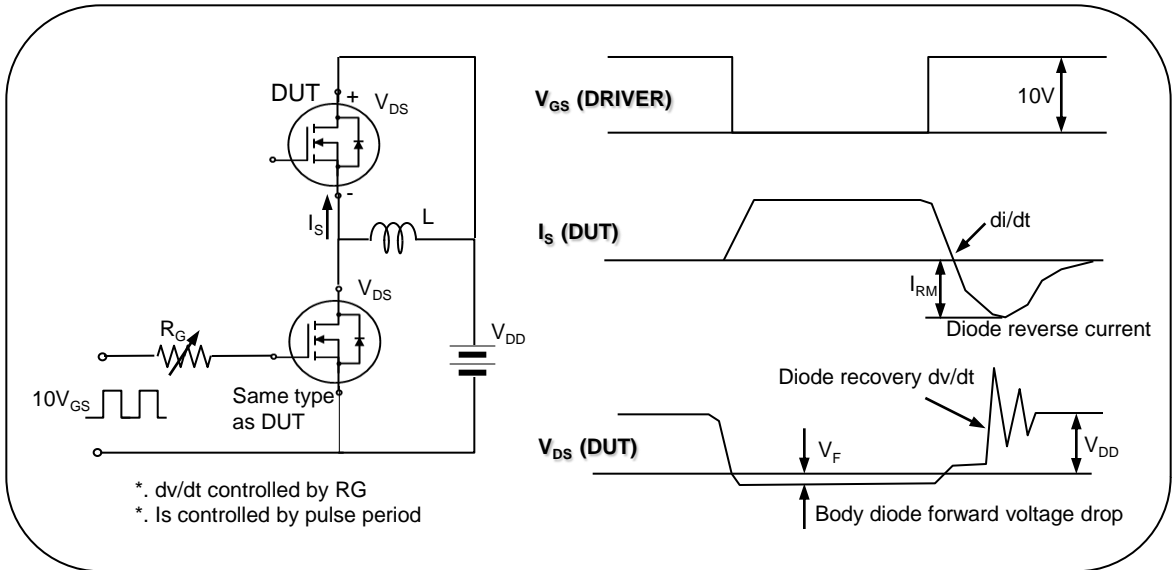

## REVISION HISTORY

Revision No.	Changed Characteristics	Responsible	Date	Issuer
REV 1.0	Origination, First Release	Alice Nie	2007.12.05	XZQ
REV 2.0	Updated the format of datasheet and added Order Codes.	Alice Nie	2011.03.24	XZQ

[WWW.SEMIPOWER.COM.CN](http://WWW.SEMIPOWER.COM.CN)



**芯派科技**  
SEMIPOWER

西安芯派电子科技有限公司

地址：西安市高新区高新一路25号创新大厦MF6

电话：029 - 88253717 传真：029 - 88251977



**芯源科技**

SAMWIN

深圳市南方芯源科技有限公司

地址：深圳市福田区天安数码城时代大厦A座2005

电话：0755 - 83981818 传真：0755 - 83476838