

---

# SPECIFICATION

ITEM	WHITE SIDE VIEW LED
MODEL	SWAF07
CUSTOMER	

## Customer

Approved by	Approved by	Approved by
/	/	/

## Supplier

Drawn by	Checked by	Approved by
/	/	/



**SEOUL SEMICONDUCTOR CO., LTD.**

---

---

## Contents

---

1. Features	02
2. Applications	02
3. Absolute Maximum Ratings	03
4. Electro-Optical Characteristics	03
5. CIE Chromaticity Diagram	04
6. Characteristic Diagram	06
7. Reliability	08
8. Precautions	09
9. Soldering Profile	10
10. Outline Dimension	11
11. Packing	12
12. Reel Packing Structure	13
13. History	14

## 1. Features

- Package: SMT Solderability
- Dimension : 3.8 × 1.05 × 0.6 (mm)
- Low Thermal Resistance
- RoHS Compliant, Lead Free
- Suitable for Small Applications
- Own Patent Reserved
- **SWAF07** is Very Useful Side View LED in Back Light Unit Application



## 2. Applications

- Flat Backlighting (LCD, Display)
- Mobile Phone, Camera, PDA, Notebook
- Coupling into Light Guide Panel
- AV Systems

## 3. Absolute Maximum Ratings

(T<sub>a</sub> = 25°C)

Parameter	Symbol	Value	Unit
Power Dissipation	P <sub>d</sub> <sup>*1</sup>	120	mW
Forward Current	I <sub>F</sub>	30	mA
Peak Forward Current	I <sub>FM</sub> <sup>*2</sup>	100	mA
Reverse Voltage	V <sub>R</sub>	5	V
Operating Temperature	T <sub>opr</sub>	-30 ~ +85	°C
Storage Temperature	T <sub>stg</sub>	-40 ~ +100	°C
Junction Temperature	T <sub>j</sub>	125	°C

\*1 Care is to be taken that Power Dissipation does not exceed the Absolute Maximum Rating of the product.

\*2 I<sub>FM</sub> conditions : Pulse width T<sub>w</sub> ≤ 0.1ms, Duty ratio ≤ 1/10

## 4. Electro-Optical Characteristics

(T<sub>a</sub> = 25°C)

Item	Symbol	Condition	Min	Typ	Max	Unit	
Forward Voltage*	Rank Y	I <sub>F</sub> = 20 mA	2.7	-	3.0	V	
	Rank Z		3.0	-	3.3		
	Rank A		3.3	-	3.7		
Reverse Current	I <sub>R</sub>	V <sub>R</sub> = 5 V	-	-	50	μA	
Luminous Intensity <sup>*1</sup>	Rank J1	I <sub>V</sub>	I <sub>F</sub> = 20 mA	1100	-	1200	mcd
	Rank J2			1200	-	1300	
	Rank J3			1300	-	1400	
	Rank J4			1400	-	1500	
	Rank J5			1500	-	1600	
	Rank J6			1600	-	1700	
	Rank J7			1700	-	1800	
	Rank J8			1800	-	1900	
	Rank J9			1900	-	2000	
Viewing Angle <sup>*2</sup>	2θ <sub>1/2</sub>	I <sub>F</sub> = 20 mA	120			°	
Color Coordinates <sup>*3</sup>	Rank b	x	I <sub>F</sub> = 20 mA	0.264	-	0.296	-
		y		0.248	-	0.295	
	Rank e	x		0.287	-	0.311	
		y		0.276	-	0.315	
	Rank f	x		0.307	-	0.330	
		y		0.294	-	0.339	

\*1 luminous intensity I<sub>V</sub> is measured at the peak of the spatial pattern which may not be aligned with the mechanical axis of the LED package. Luminous Intensity Measurement allowance is ±10%.\*2 θ<sub>1/2</sub> is the off-axis where the luminous intensity is 1/2 of the peak intensity.

\*3 Measurement Uncertainty of the Color Coordinates is ±0.01

\* Note : All products confirm to the listed minimum and maximum specifications for electric and optical characteristics, when operated at 20mA within the maximum ratings shown above.

All measurements were made under the standardized environment of Seoul Semiconductor.

5. CIE Chromaticity Diagram

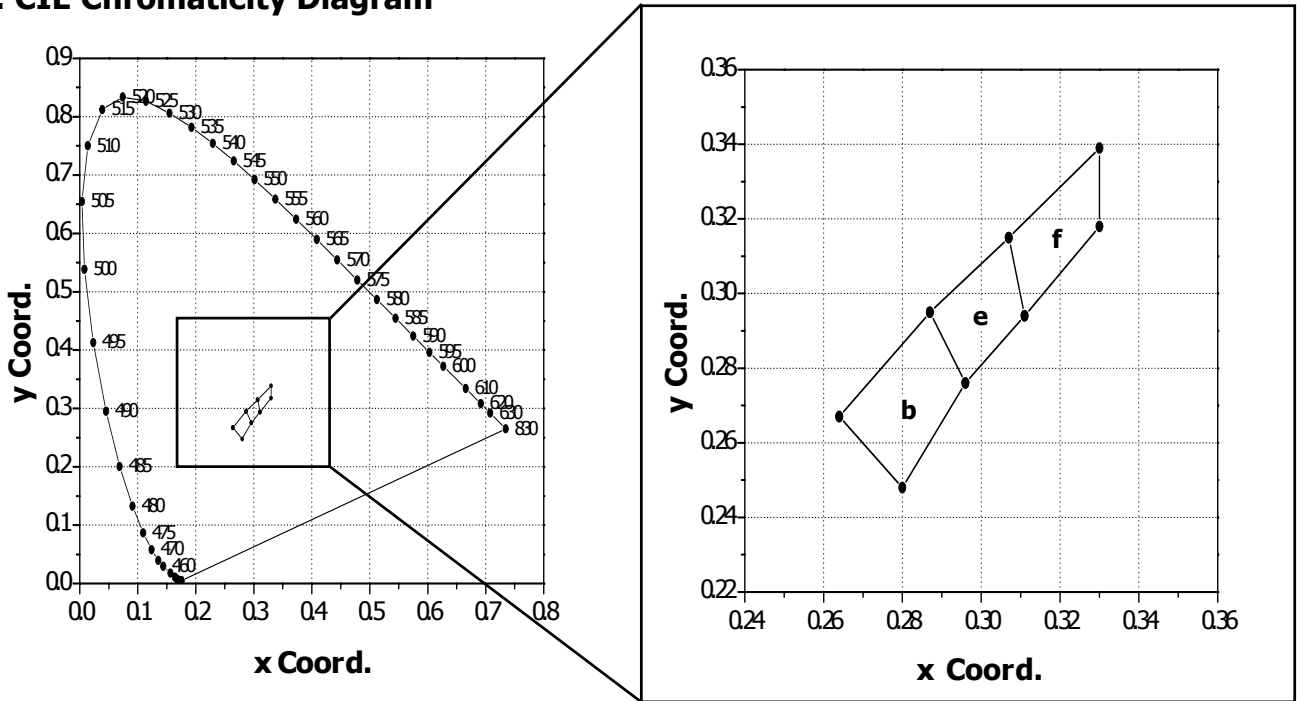

● Luminous Intensity

Ranking by Color Coordinates				b	e	f
Ranking by Luminous Intensity						
RANK	Min	Max	Unit			
J1	1100	1200	mcd	√		
J2	1200	1300		√	√	
J3	1300	1400		√	√	√
J4	1400	1500		√	√	√
J5	1500	1600		√	√	√
J6	1600	1700		√	√	√
J7	1700	1800		√	√	√
J8	1800	1900			√	√
J9	1900	2000				√

\* The Checked ranks are available

● Color Rank

( $I_F = 20 \text{ mA}$ ,  $T_a = 25^\circ\text{C}$ )

B		e		f	
x	y	x	y	x	y
0.264	0.267	0.296	0.276	0.311	0.294
0.280	0.248	0.311	0.294	0.330	0.318
0.296	0.276	0.307	0.315	0.330	0.339
0.287	0.295	0.287	0.295	0.307	0.315

### 6. Characteristic Diagram

Forward Current vs. Forward Voltage

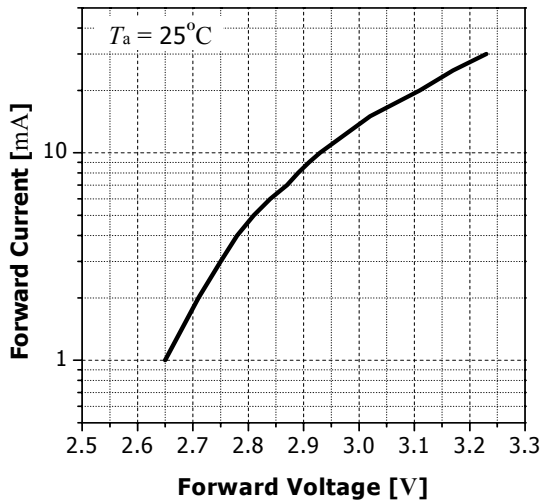

Intensity vs. Forward Current

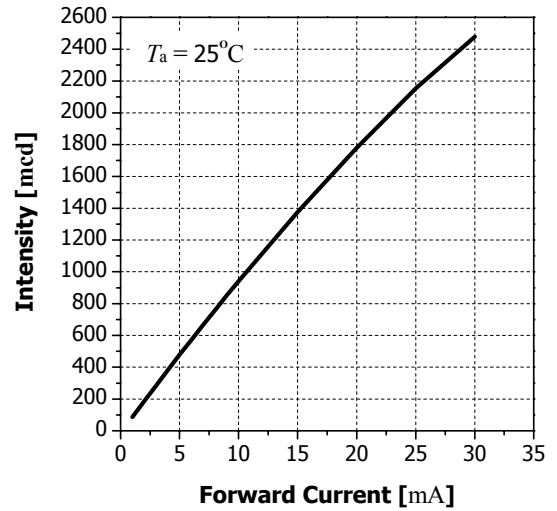

Forward Current vs. Ambient Temperature

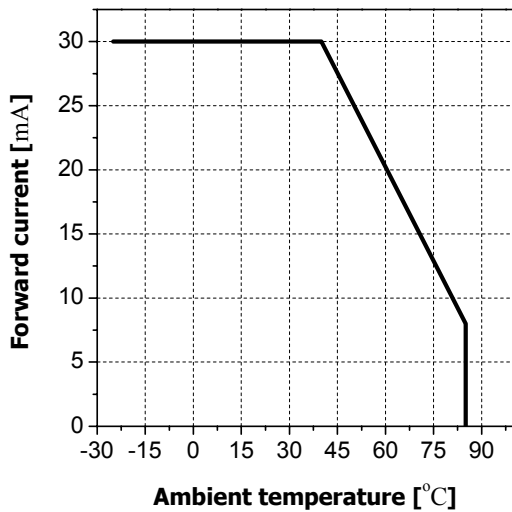

Radiation Diagram

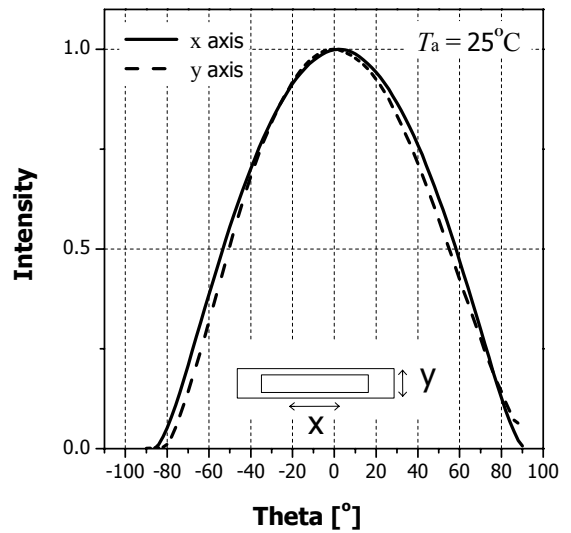

Color Coordinate vs. Forward Current

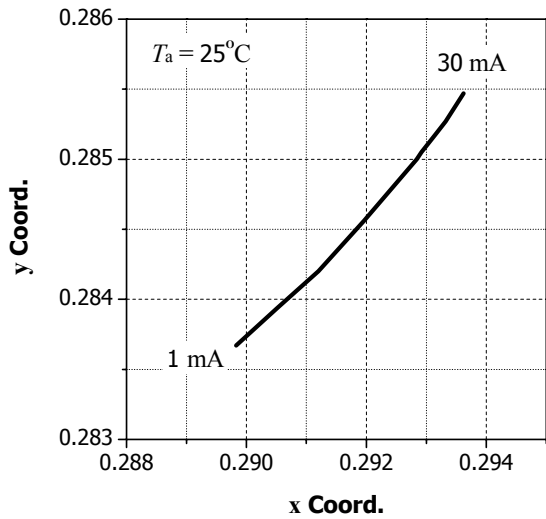

Spectrum

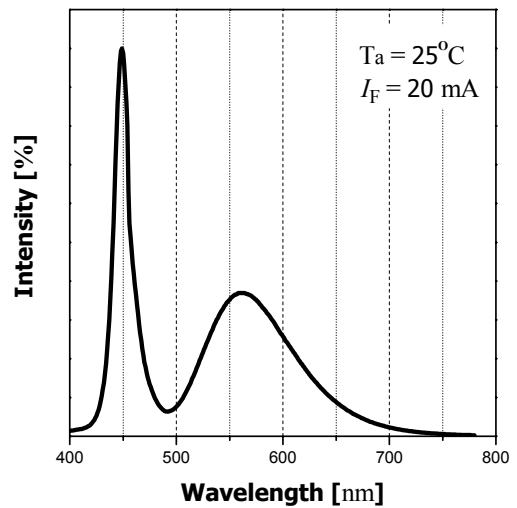

Forward Voltage vs. Ambient Temperature

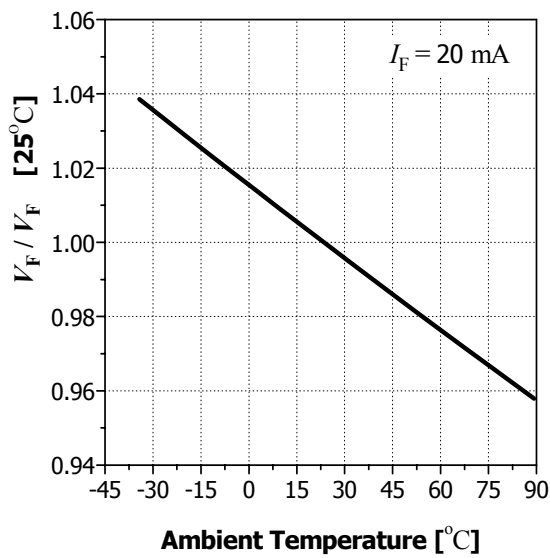

Color Coordinate vs. Ambient Temperature

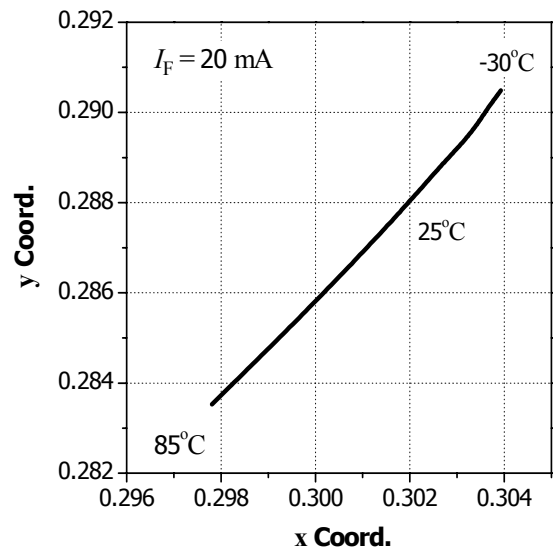

Relative Luminosity vs. Ambient Temperature

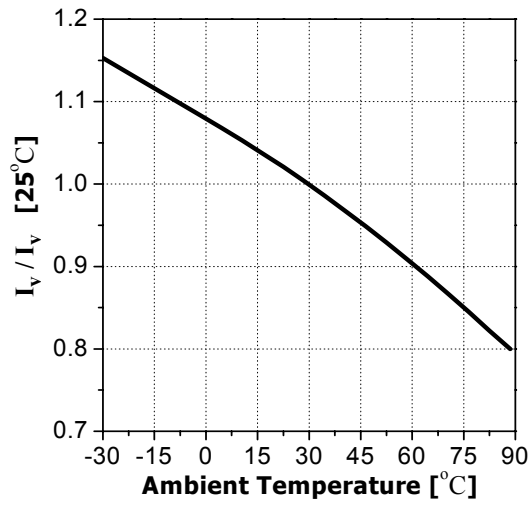

Allowable Forward Current vs. Duty Ratio

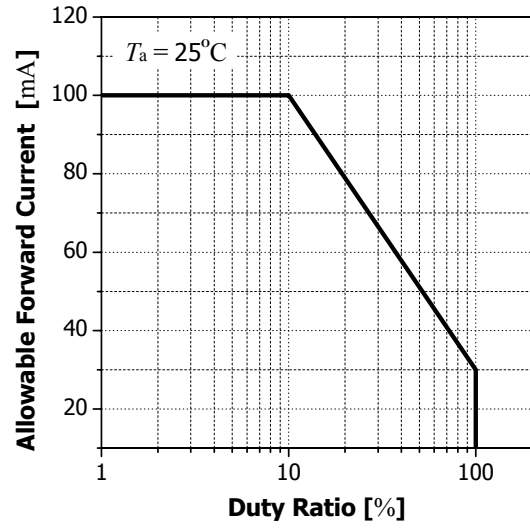



## 7. Reliability

### (1) TEST ITEMS AND RESULTS

TEST ITEM	Test conditions	Note	Number of Damaged	Reference
Life Test 1	$T_a = 25^\circ\text{C}; I_F = 20 \text{ mA}$	1000 hr	0/20	EIAJ ED-4701 100 101
Life Test 2	$T_a = 25^\circ\text{C}; I_F = 30 \text{ mA}$	500 hr	0/20	EIAJ ED-4701 100 101
Thermal Shock	$-30^\circ\text{C} \sim 85^\circ\text{C}$ (30 min) (30 min)	20 cycle	0/50	EIAJ ED-4701 300 307
High Temperature Life Test	$T_a = 85^\circ\text{C}; I_F = 5 \text{ mA}$	1000 hr	0/20	-
Low Temperature Life Test	$T_a = -30^\circ\text{C}; I_F = 20 \text{ mA}$	1000 hr	0/20	-
High Temperature Storage	$T_a = 100^\circ\text{C}$	1000 hr	0/50	EIAJ ED-4701 200 201
Low Temperature Storage	$T_a = -40^\circ\text{C}$	1000 hr	0/50	EIAJ ED-4701 200 202
High Humidity Heat Life Test	$T_a = 60^\circ\text{C}; RH = 90\%, I_F = 20 \text{ mA}$	500 hr	0/20	EIAJ ED-4701 100 102
Humidity Heat Load	$T_a = 85^\circ\text{C}; RH = 85\%$	1000 hr	0/50	EIAJ ED-4701 100 103
Resistance to Soldering Heat	$T_{\text{sld}} = 260^\circ\text{C}, 10 \text{ sec}$ Pre treatment; $30^\circ\text{C}, 70\%, 168 \text{ hr}$	2 time	0/50	EIAJ ED-4701 301 302
Solder ability (Reflow Soldering)	$T_{\text{sld}} = 215 \pm 5^\circ\text{C}, 3 \text{ sec}$ (Lead Solder)	1 time over 95%	0/50	EIAJ ED-4701 303
Temperature Cycle	$-40^\circ\text{C} \sim 25^\circ\text{C} \sim 100^\circ\text{C} \sim 25^\circ\text{C}$ (30 min) (5 min) (30 min) (5 min)	100 cycle	0/50	EIAJ ED-4701 100 105
Moisture Resistance Cycle	$25^\circ\text{C} \sim 65^\circ\text{C} \sim -10^\circ\text{C}$ $RH = 90\%, 24 \text{ hr} / 1 \text{ cycle}$	10 cycle	0/50	EIAJ ED-4701 200 203

### (2) CRITERIA FOR JUDGING THE DAMAGE

Item	Symbol	Test Condition	Criteria for Judgment	
			Min.	Max.
Forward Voltage	$V_F$	$I_F = 20 \text{ mA}$	-	U.S.L $\times$ 1.2
Reverse Current	$I_R$	$V_R = 5 \text{ V}$	-	U.S.L $\times$ 2.0
Luminous Intensity	$I_V$	$I_F = 20 \text{ mA}$	L.S.L $\times$ 0.5	-

U.S.L. : Upper Standard Level, L.S.L. : Lower Standard Level

## 8. Precautions

### (1) Storage conditions

- Keep the product in a dry box or a desiccator with a desiccant in order to prevent moisture absorption.
  - a. Keep it at a temperature in the range from 5°C to 30°C and at a humidity of less than 60% RH.
- In case of being stored for more than 3 months, the product should be sealed with Nitrogen gas.

### (2) After opening the package

- When soldering, this could result in a decrease of the photoelectric effect or light intensity.
  - a. Soldering should be done right after mounting the product.
  - b. Keep the temperature in the range from 5°C to 40°C and the humidity at less than 30%.

- Soldering should be done within 7 days after opening the desiccant package.

If the product has been exposed for more than 7 days after opening the package or the indicating color of the desiccator changes, the product must be baked at a temperature between 60°C and 65°C for 10 to 12 hours.

- An unused and unsealed product should be repacked in a desiccant package and kept sealed in a dry atmosphere.

### (3) Precautions for use

- Any external mechanical force or excessive vibration should not be applied to the product during cooling after soldering, and it is preferable to avoid rapid cooling.
- The product should not be mounted on a distorted part of PCB.
- Gloves or wrist bands for ESD(Electric Static Discharge) should be worn in order to prevent ESD and surge damage, and all devices and equipments must be grounded to the earth.

### (4) Miscellaneous

- Radiation resistance is not considered.
- When cleaning the product, any kind of fluid such as water, oil and organic solvent must not be used and IPA(Isopropyl Alcohol) must be used.
- When using the product, operating current should be settled in consideration of the maximum ambient temperature.
- Its appearance or specification for improvement is subject to change without notice.

### 9. Soldering Profile

The LED can be soldered in place using the reflow soldering method.

(1) Lead solder

Preliminary heating to be at maximum 210°C for maximum 2 minutes.

Soldering heat to be at maximum 240°C for maximum 10 seconds.

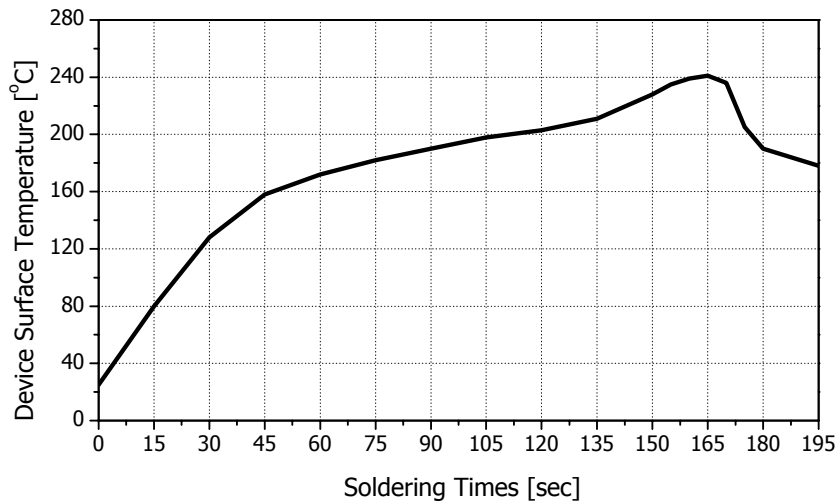

(2) Lead-free solder

Preliminary heating to be at maximum 220°C for maximum 2 minutes.

Soldering heat to be at maximum 260°C for maximum 10 seconds.

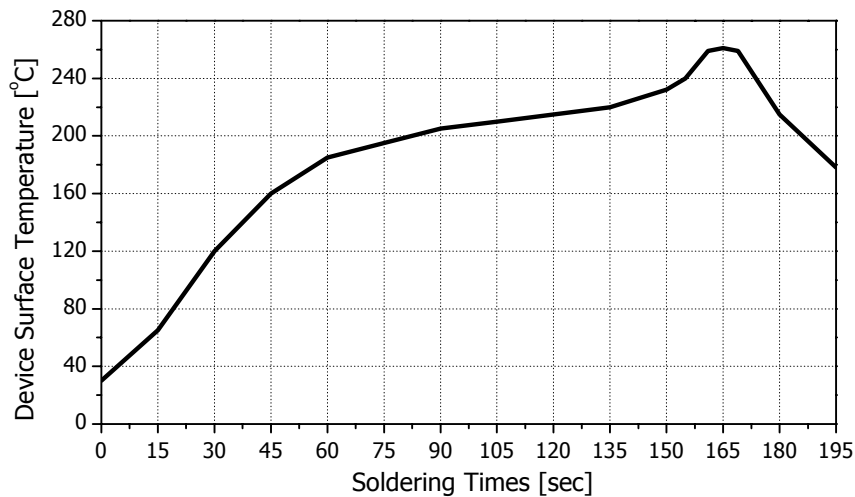

(3) Hand Soldering conditions

Not more than 5 seconds @MAX 300°C, under Soldering iron.

10. Outline Dimension

( Tolerance :  $\pm 0.2$ , Unit : mm )

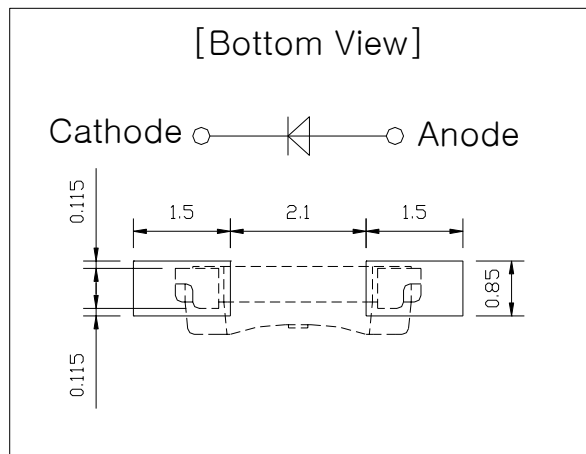
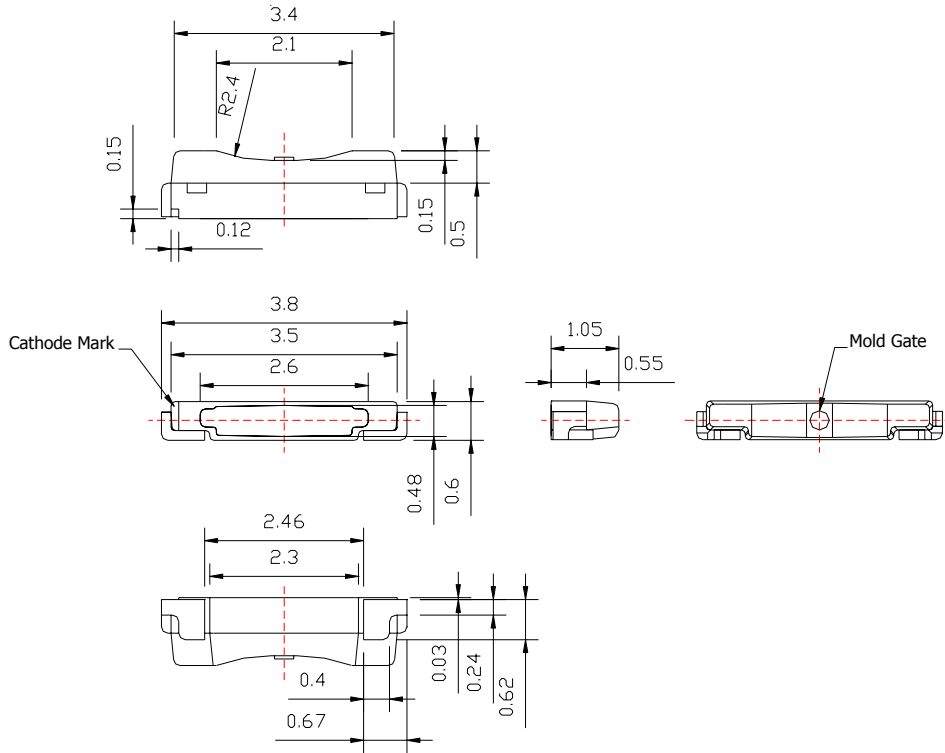

<Recommended solder Pattern>

11. Packing

( Tolerance :  $\pm 0.2$ , Unit : mm )

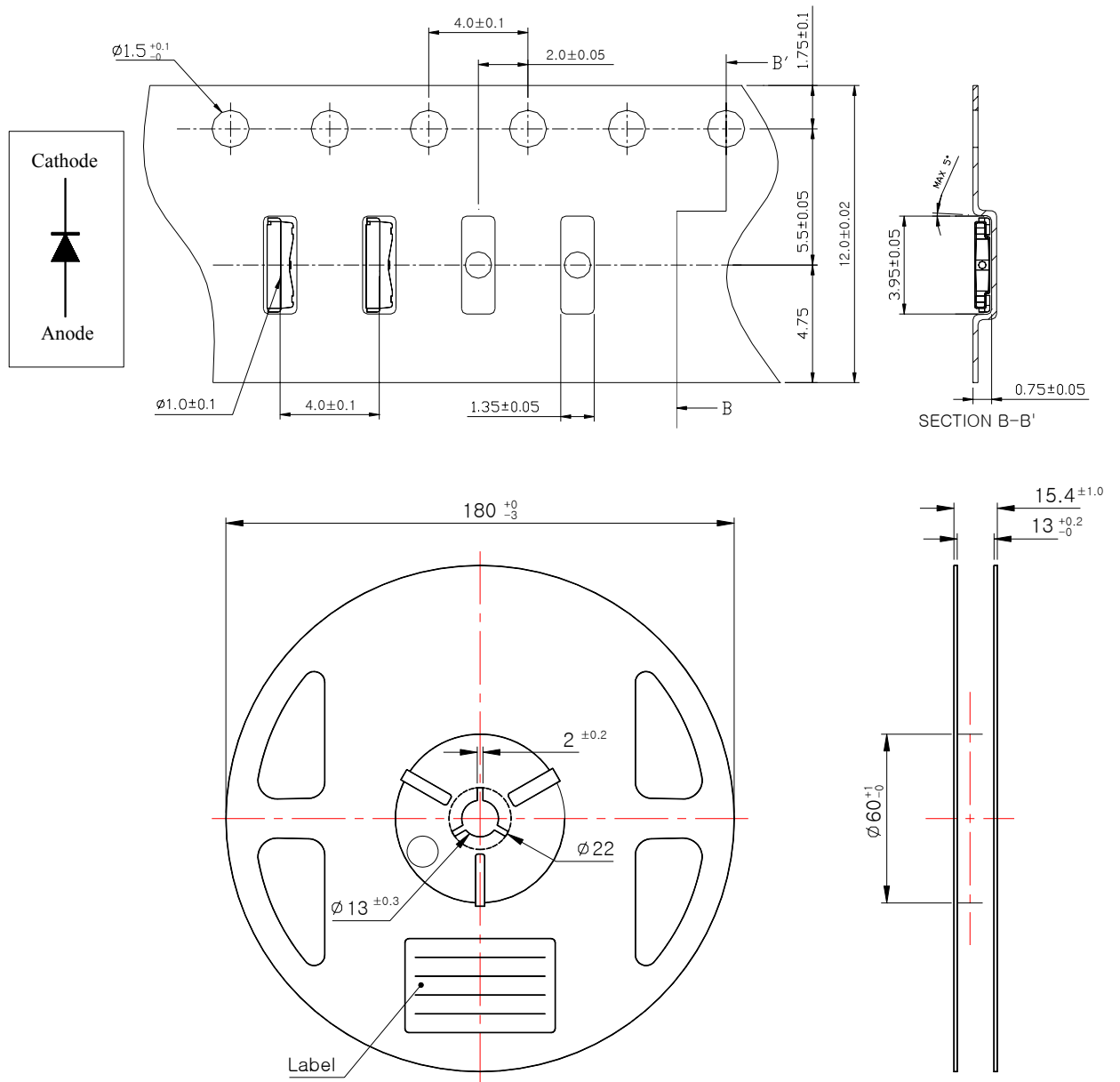

- (1) Quantity: 3500 pcs / Reel
- (2) Cumulative Tolerance: Cumulative Tolerance / 10 pitches to be  $\pm 0.2$  mm
- (3) Adhesion Strength of Cover Tape: Adhesion strength to be 0.1 - 0.7 N when the cover tape is turned off from the carrier tape at  $10^\circ$  angle to be the carrier tape
- (4) Package: P/N, Manufacturing data Code No. and quantity to be indicated on a damp proof Package

## 12. Reel Packing Structure

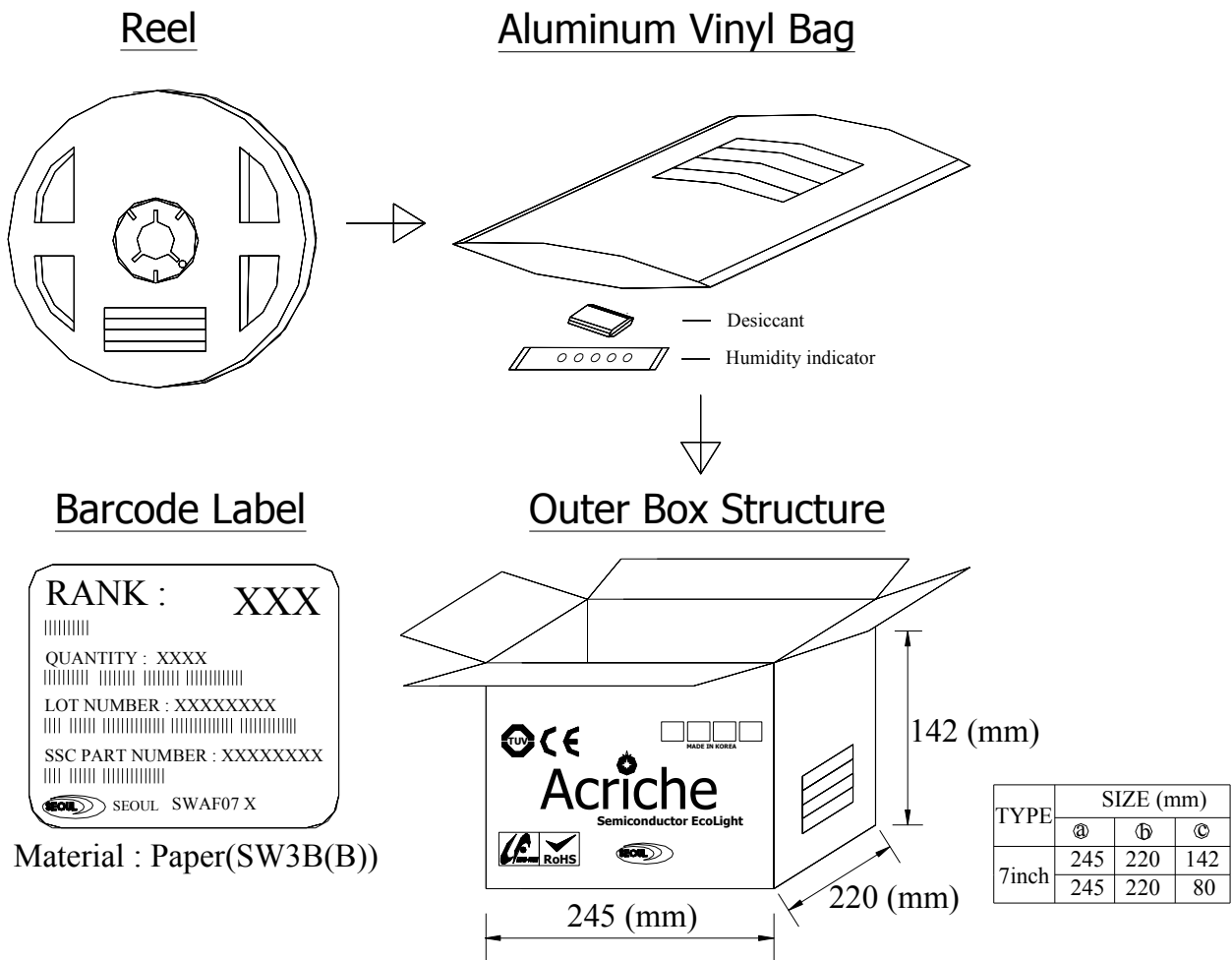

● **Lot Number**

The lot number is composed of the following characters;

**SWAF07** ○□□◎◎ ◇◇◇

Symbol	Meaning	Example
○	Year	8 for 2008, 9 for 2009 ····
□□	Month	01 for Jan., 02 for Feb., ···· 12 for Dec.
◎◎	Day	01, 02, 03, 04, 05, ···· 27, 28, 29, 30, 31
◇◇◇	Number	001, 002, 003, 004, 005, 006, 007 ····

**13. History**

Rev. No.	Contents	Date
1.00	- The institution of New Spec.	2008. 06. 03

Published by  
SEOUL SEMICONDUCTOR CO., LTD.  
<http://www.seoulsemicon.com>  
148-29, Gasan-Dong, Geumcheon-Gu,  
Seoul, 153-801. South Korea  
© All Right Reserved.