

## Rectifier Diode SXXHN/HR680

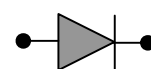

Symbol	Characteristics	Conditions	$T_J(^{\circ}\text{C})$	Value	Unit
<b>BLOCKING PARAMETERS</b>					
$V_{RRM}$	Repetitive peak reverse voltage		160	200-3000	V
$I_{RRM}$	Repetitive peak reverse current	$V = V_{RRM}$	160	50	mA
<b>CONDUCTING PARAMETERS</b>					
$I_{F(AV)}$	Average on-state current	180 sine, 50Hz, $T_C = 90^{\circ}\text{C}$		680	A
$I_{RMS}$	RMS on-state current			1070	A
$I_{FSM}$	Non repetitive peak surge on-state current	Sine wave, 10mS without reverse voltage	160	14000	A
$I^2t$	Permissible surge energy			980	kJ <sup>2</sup> S
$V_{FM}$	Peak on-state voltage drop	On-state current = 2100A	160	1.55	V
$V_0$	Typical forward conduction Threshold voltage		160	0.80	V
$r_0$	Typical forward slope resistance		160	0.33	m $\Omega$
<b>THERMAL &amp; MECHANICAL PARAMETERS</b>					
$R_{TH(J-C)}$	Thermal impedance, 180 <sup>o</sup> conduction, Sine	Junction to case		0.07	<sup>o</sup> C/W
$R_{TH(C-HK)}$	Thermal impedance	Case to heatsink		0.02	<sup>o</sup> C/W
$T_J$	Maximum Permissible junction temperature			160	<sup>o</sup> C
$T_{STG}$	Storage temperature range			-40 – 160	<sup>o</sup> C
F	Mounting Torque			20	NM
W	Weight			875	gms



# HIND RECTIFIERS LTD

# Rectifier Diode SXXHN/HR680

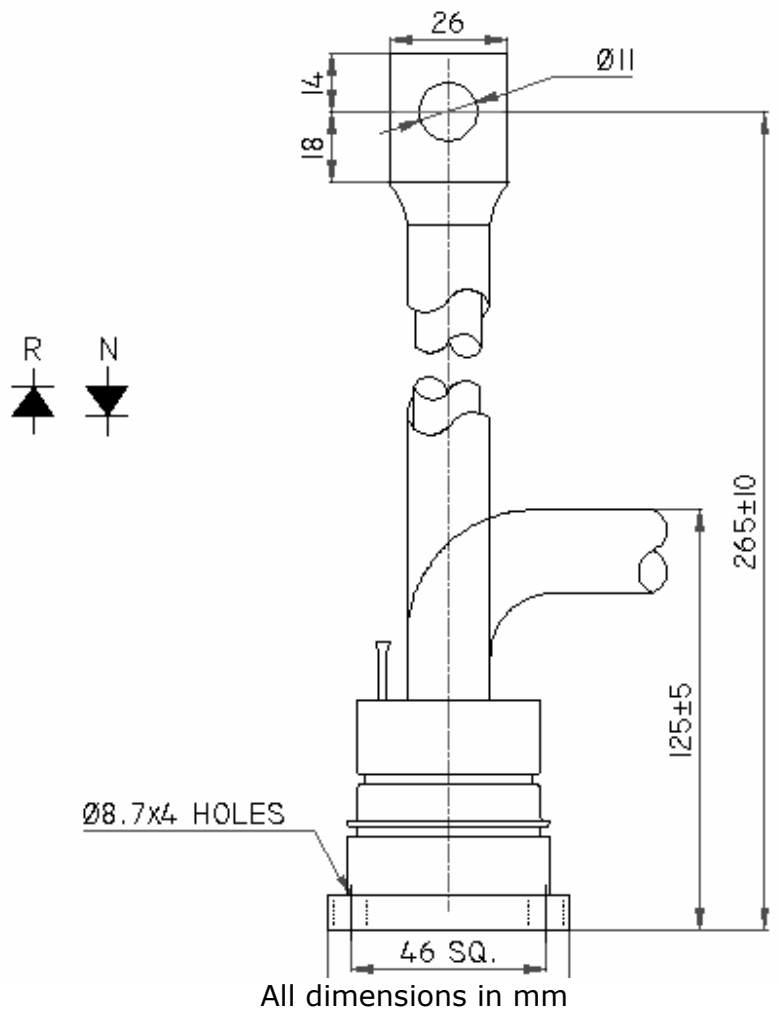
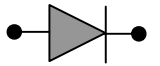

## On State Power Loss

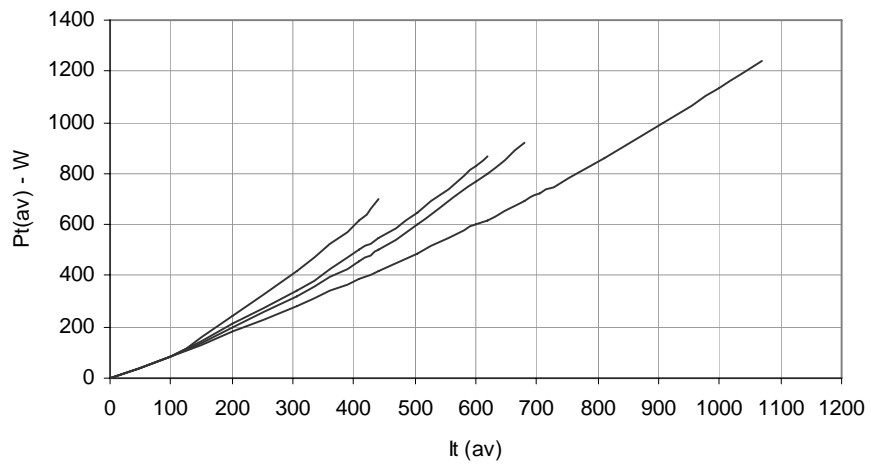

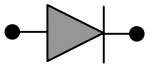

Maximum Permissible Case Temp

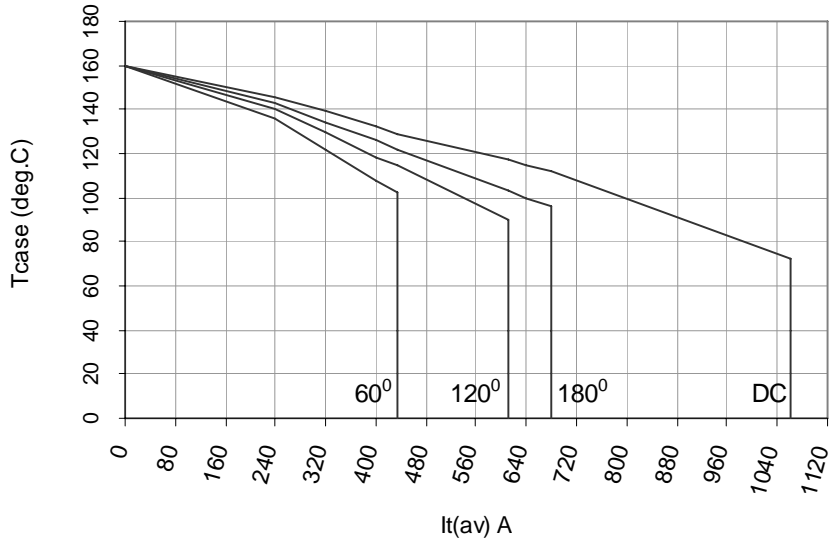

Max non repetitive Surge Current

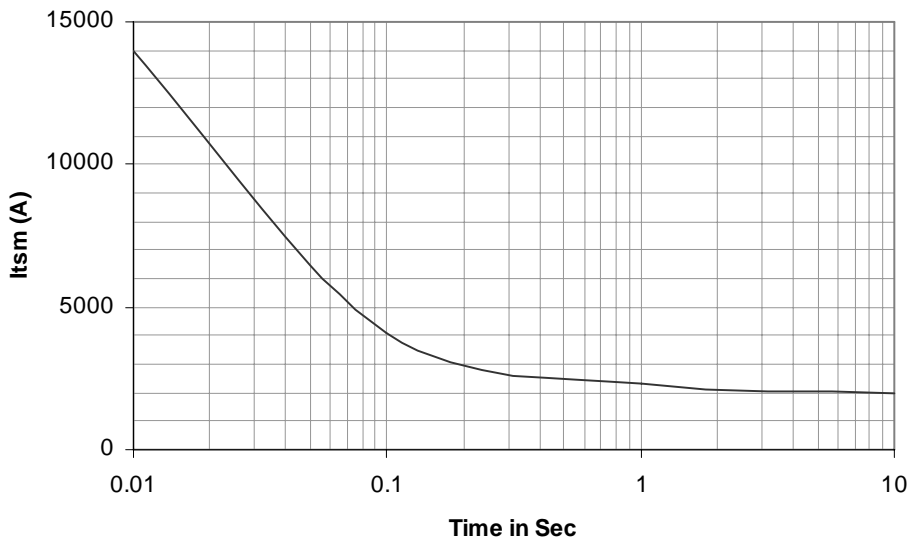

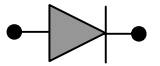

Transient Thermal Impedance Junction to Case

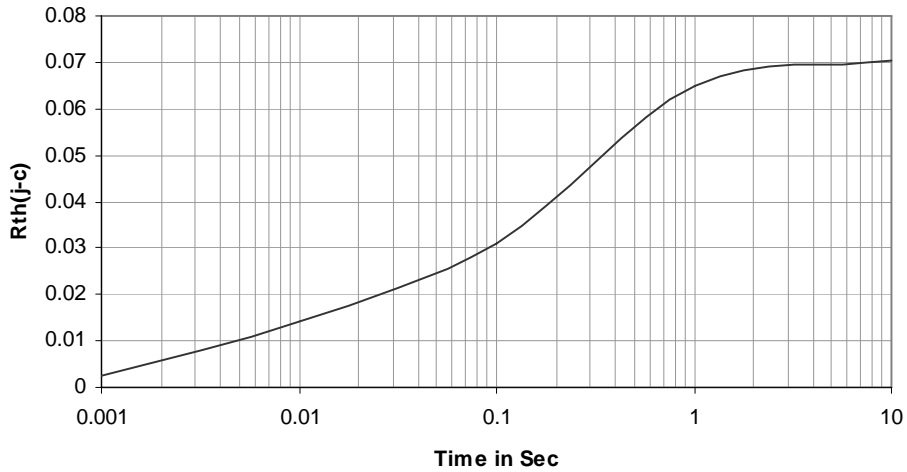

On State Characteristics

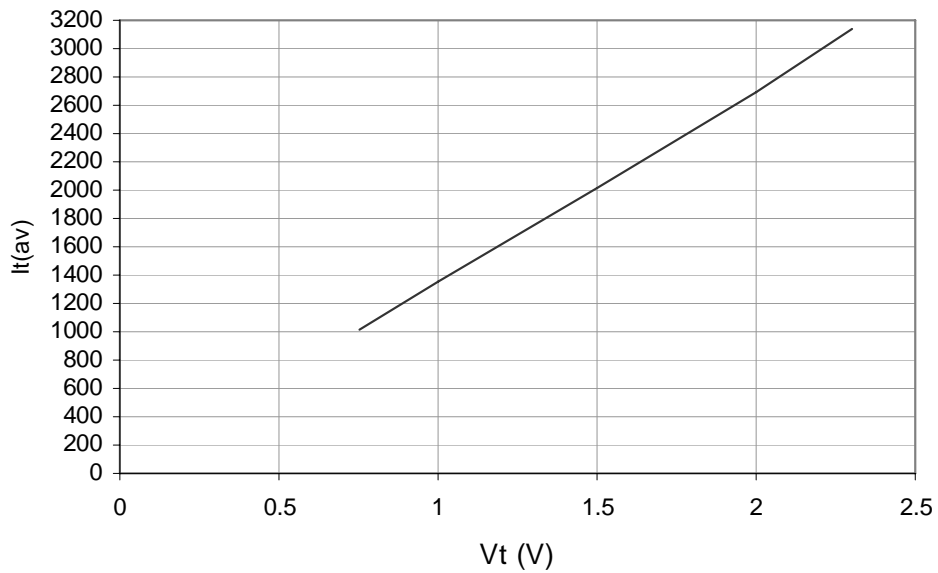

## Rectifier Diode SXXHN/HR680

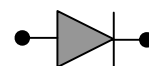

### Ordering Information: -

<b>S</b>	<b>XX</b>	<b>HN / HR</b>	<b>680</b>
Hirect make Rectifier Diode	$V_{RRM} = XX * 100$ e.g. 12 * 100 = 1200V	HN - Normal Polarity HR - Reverse Polarity	$I_{F(AV)} = 680A$

Hind Rectifiers Ltd reserves the right to change the specifications without notice.

This datasheet specifies technical information for semiconductor devices but promises no characteristics. No warranty or guarantee expressed or implied is made regarding delivery, performance or suitability.

### Hind Rectifiers Ltd

Lake Road

Bhandup (West)

Mumbai – 400 078

Tel: - +91 22 2596 8027/28/29/31

Fax: - +91 22 2596 4114

E-mail: - [marketing@hirect.com](mailto:marketing@hirect.com)

Website: - [www.hirect.com](http://www.hirect.com)

June-2008



# HIND RECTIFIERS LTD

5 of 5