

**SY3518 / SY3518(B)****1. Features**

- ◆ Yellow colored diffusion transparency lens type
- ◆  $\phi 3\text{mm(T-1)}$  all plastic mold type
- ◆ Wide half angle of intensity( $\theta_{1/2}=\pm 55^\circ$ )

**2. Outline Dimensions**

unit : mm

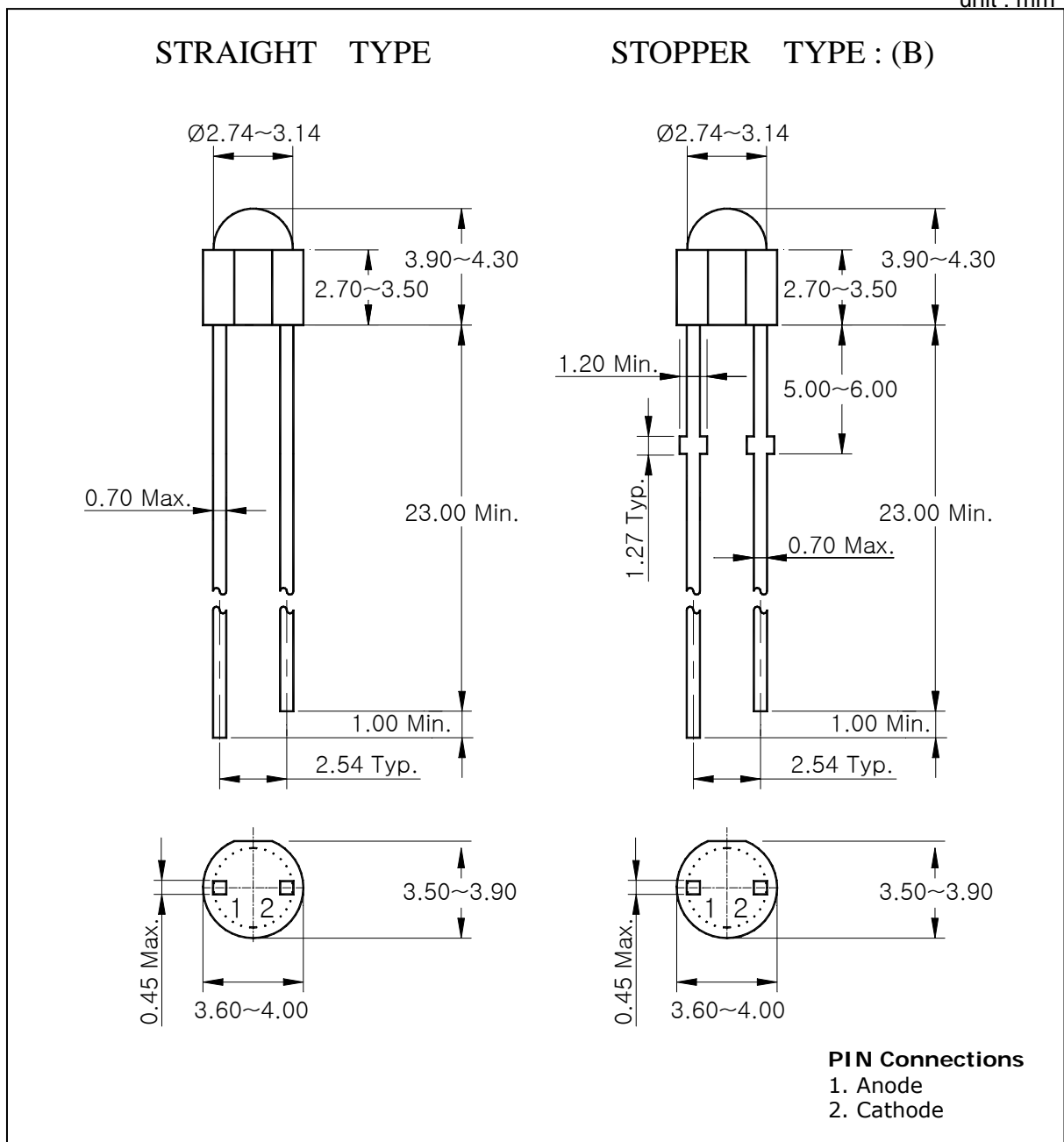

The contents of this data sheet are subject to change without advance notice for the purpose of improvement.  
When using this product, would you please refer to the latest specifications.

**SY3518 / SY3518(B)****3. Absolute Maximum Ratings**

(Ta=25°C)

Characteristic	Symbol	Rating	Unit
Power dissipation	$P_D$	75	mW
Forward current	$I_F$	30	mA
*1Peak forward current	$I_{FP}$	50	mA
Reverse voltage	$V_R$	4	V
Operating temperature range	$T_{opr}$	-25~85	°C
Storage temperature range	$T_{stg}$	-30~100	°C
*2Soldering temperature	$T_{sol}$	260°C for 10 seconds	

\*1.Duty ratio = 1/16, Pulse width = 0.1ms

\*2.Keep the distance more than 2.0mm from PCB to the bottom of LED package

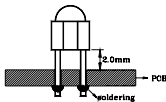
**4. Electrical / Optical Characteristics**

(Ta=25°C)

Characteristic	Symbol	Test Condition	Min	Typ	Max	Unit
Forward voltage	$V_F$	$I_F=20\text{mA}$	-	2.1	2.5	V
*4Luminous intensity	$I_V$	$I_F=20\text{mA}$	6.6	-	27	mcd
Peak wavelength	$\lambda_P$	$I_F=20\text{mA}$	-	585	-	nm
Spectrum bandwidth	$\Delta\lambda$	$I_F=20\text{mA}$	-	30	-	nm
Reverse current	$I_R$	$V_R=4\text{V}$	-	-	10	uA
*3Half angle	$\theta_{1/2}$	$I_F=20\text{mA}$	-	$\pm 55$	-	deg

\*3.  $\theta_{1/2}$  is the off-axis angle where the luminous intensity is 1/2 the peak intensity\*4. Luminous intensity maximum tolerance for each grade classification limit is  $\pm 18\%$ 

\*4. Luminous Intensity Classification

F	G	H
6.6 ~ 10	10 ~ 17	17 ~ 27

The contents of this data sheet are subject to change without advance notice for the purpose of improvement.  
When using this product, would you please refer to the latest specifications.

**5. Characteristic Diagrams**

**Fig. 1  $I_F - V_F$**

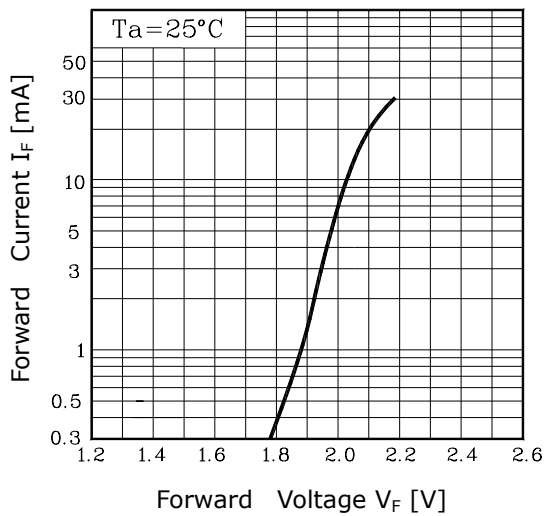

**Fig. 2  $I_v - I_F$**

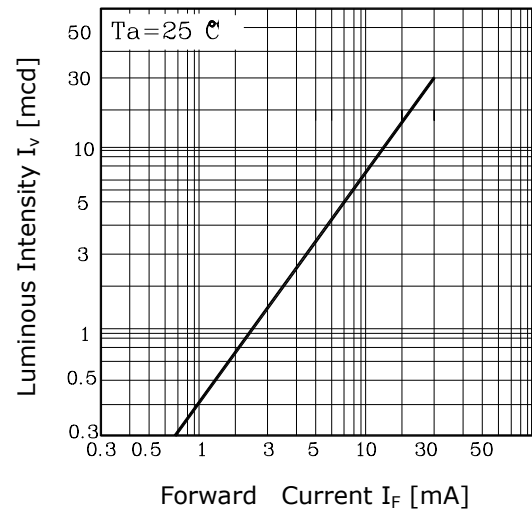

**Fig. 3  $I_F - T_a$**

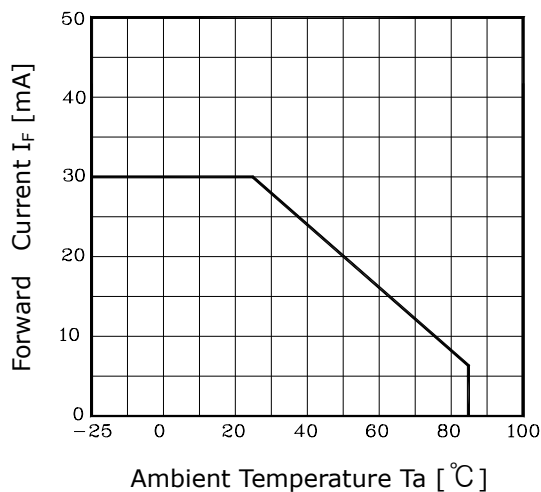

**Fig.4 Spectrum Distribution**

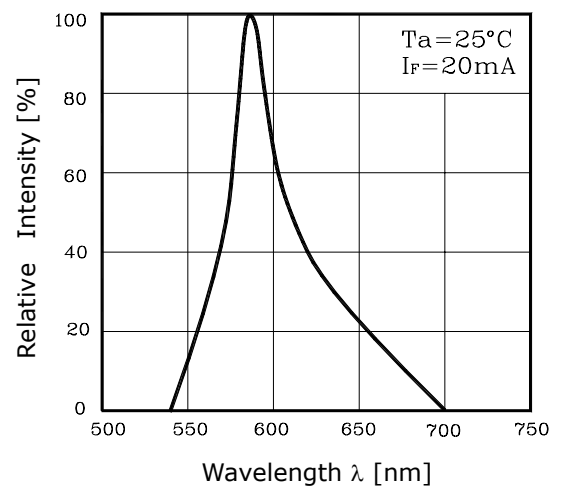

**Fig. 5 Radiation Diagram**

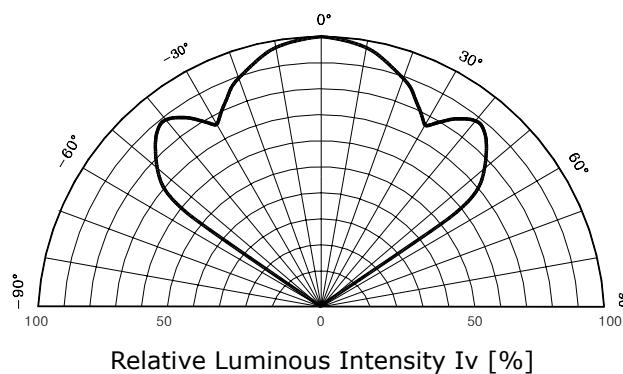

The contents of this data sheet are subject to change without advance notice for the purpose of improvement. When using this product, would you please refer to the latest specifications.