



LCD Module Technical Specification

First Edition
Oct 8, 2002

Final Revision

Type No. **T-51410D104J-FW-P-AC**

Approved by (Production Div.)

Checked by (Quality Assurance Div.)

Checked by (ACI Engineering Div.)

Prepared by (Production Div.)

NO.	ITEM	PAGE
-	Contents	1
1	Application	2
2	Features	2
3	Mechanical Specifications	2
4	Mechanical Drawing of TFT-LCD module	3
5	Input / Output Terminals	4
6	Absolute Maximum Ratings	6
7	Electrical Characteristics	6
8	Power On Sequence	12
9	Optical Characteristics	13
10	Handling Cautions	16
11	Reliability Test	17
12	Indication of Label	17
13	Block Diagram	18
14	Standard	19
15	Packing	24
-	Revision History	25

1. Application

This data sheet applies to a color TFT LCD module, T-51410D104J-FW-P-AC.

T-51410D104J-FW-P-AC module applies to notebook PC, sub-note-book PC and other OA product, which require high quality flat panel display. **This module is not designed for aerospace, avionics, medical, F/A, transportation, car or any other products, which require extreme level of reliability.**

Prime View assume no responsibility for any damage resulting from the use of the device which dose not comply with the instructions and the precautions in these specification sheet.

2. Features

- . Amorphous silicon TFT LCD panel with back-light unit
- . Pixel in stripe configuration
- . Slim and compact, designed for O/A application
- . Display Colors:262,144 colors
- . Optimum Viewing Direction:6 o'clock
- . 3.3V LVDS interface standard: DS90CF364 as receiver
- . +3.3V DC supply voltage for TFT LCD panel driving
- . Backlight driving DC/AC inverter not included in this module
- . Long Life Lamp

3. Mechanical Specifications

Parameter	Specifications	Unit
Screen Size	26.4(diagonal)	cm
	10.4 (diagonal)	inch
Display Format	800× (R, G, B)×600	dot
Display Colors	262,144	
Active Area	211.2(H)×158.4 (V)	mm
Pixel Pitch	0.264 (H)×0.264 (V)	mm
Pixel Configuration	Stripe	
Outline Dimension	238.6 (w)×171.0(H)×6.0(typ.) (D)	mm
Weight	310(typ.),320(max.)	g
Back-light	Single CCFL, side-light type	
Surface treatment	Anti-glare and hard-coating	
Display mode	Normally white	

4. Mechanical Drawing of TFT-LCD Module

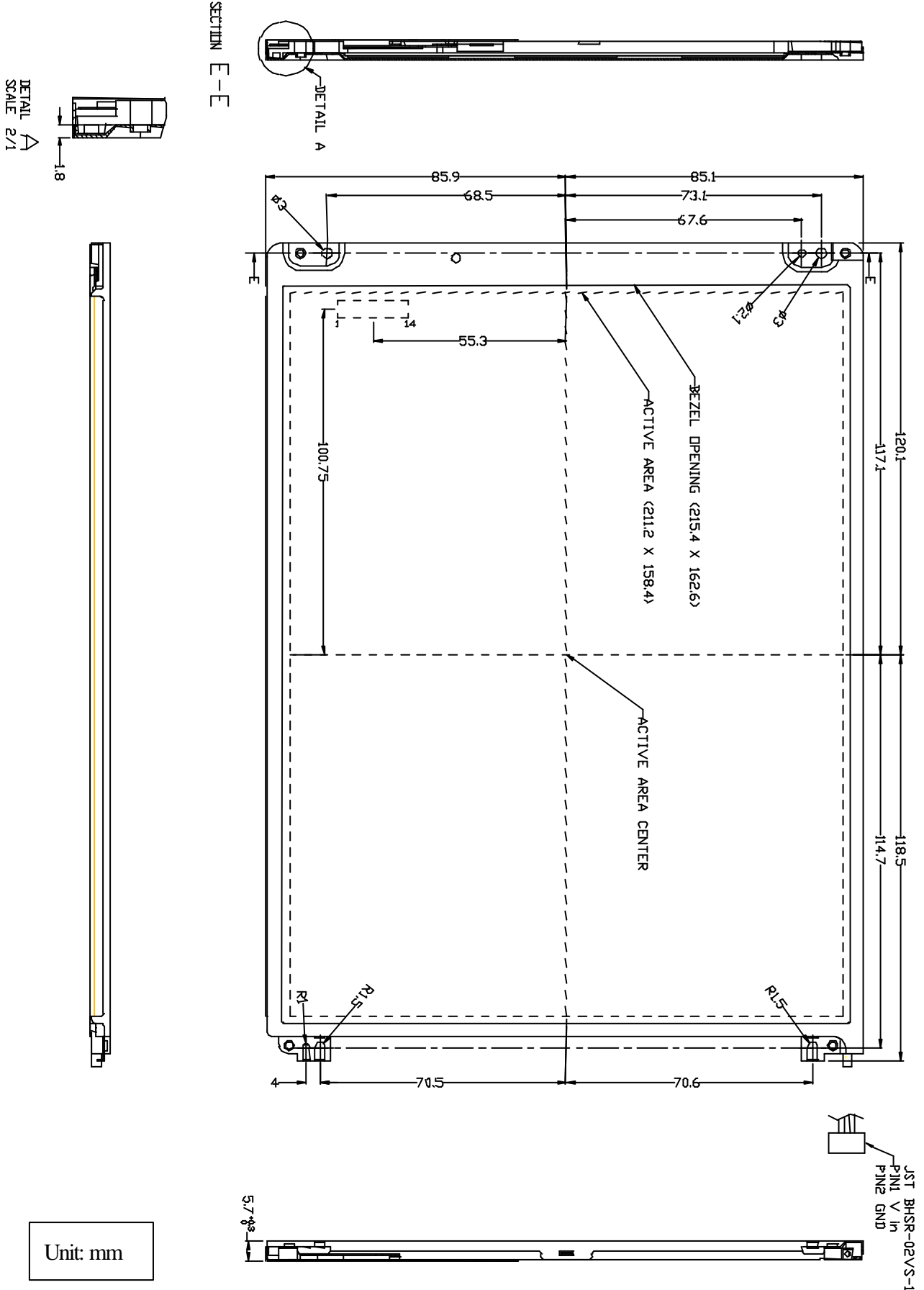

Unit: mm

5. Input Terminals

5-1) TFT-LCD Panel Driving

Connector type: Molex 55177-1491

Pin No.	Symbol	Function	Remark
1	VDD	Power supply : +3.3V	
2	VDD	Power supply : +3.3V	
3	GND		
4	GND		
5	IN0-	Pixel data Transmission pair 0 (negative -)	
6	IN0+	Pixel data Transmission pair 0 (positive +)	
7	IN1-	Pixel data Transmission pair 1 (negative -)	
8	IN1+	Pixel data Transmission pair 1 (positive +)	
9	IN2-	Pixel data Transmission pair 2 (negative -)	
10	IN2+	Pixel data Transmission pair 2 (positive +)	
11	CLK-	Sampling Clock (negative -)	
12	CLK+	Sampling Clock (positive +)	
13	GND		
14	GND		

Recommended Transmitter (DS90C*363 of National Semiconductor) to T-51410D104J-FW-P-AC interface Assignment:

Input terminal of DS 90C*363		Graphic controller output signal		Output signal symbol	To T-51410D104J-FW-P-AC Interface terminal(Symbol)
Symbol	No.	Symbol	Function		
TIN0	44	R0	Red pixel data (LSB)	Tout0- Tout0+	No.5 : IN0- No.6 : IN0+
TIN1	45	R1	Red pixel data		
TIN2	47	R2	Red pixel data		
TIN3	48	R3	Red pixel data		
TIN4	1	R4	Red pixel data		
TIN5	3	R5	Red pixel data(MSB)		
TIN6	4	G0	Green pixel data (LSB)	Tout1- Tout1+	No.7 : IN1- No.8 : IN1+
TIN7	6	G1	Green pixel data		
TIN8	7	G2	Green pixel data		
TIN9	9	G3	Green pixel data		
TIN10	10	G4	Green pixel data		
TIN11	12	G5	Green pixel data(MSB)		
TIN12	13	B0	Blue pixel data(LSB)	Tout2- Tout2+	No.9 : IN2- No.10 : IN2+
TIN13	15	B1	Blue pixel data		
TIN14	16	B2	Blue pixel data		
TIN15	18	B3	Blue pixel data		
TIN16	19	B4	Blue pixel data		
TIN17	20	B5	Blue pixel data(MSB)		
TIN18	22	NC	No connection	TCLK out- TCLK out+	No.11 : CLK IN- No.12 : CLK IN+
TIN19	23	NC	No connection		
TIN20	25	ENAB	Compound Synchronization signal		
CLK in	26	NCLK	Data sampling clock		

Data stream of IN0-/+ , IN1-/+ and IN2-/+ for T-51410D104J-FW-P-AC

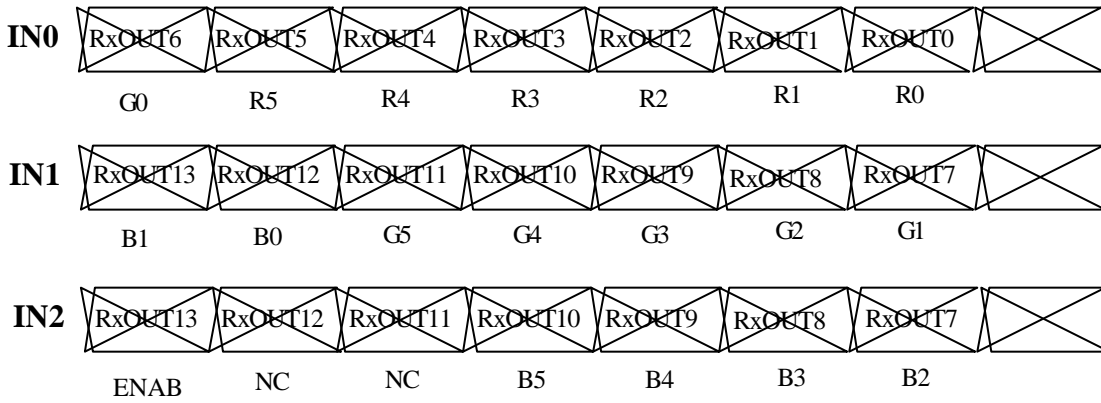

LVDS Interface Block Diagram

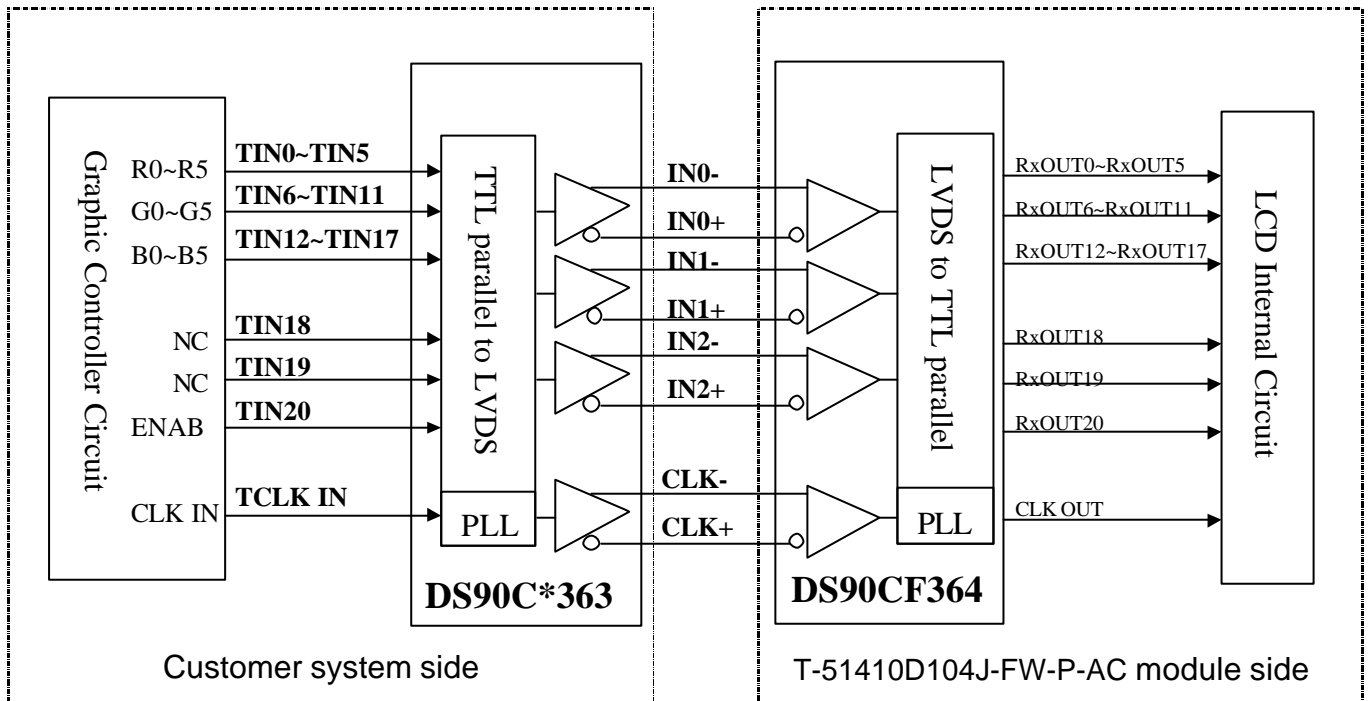

5-2) Backlight driving

Connector type : "BHR-02VS-1" of Japan Solderless Terminal MFG Co. LTD

PIN NO.	Symbol	Description	Remark
1	VL1	Input Voltage(High)	
2	VL2	Input Voltage(Low)	

6. Absolute Maximum Ratings:

GND=0V, Ta=25°C

Parameters	Symbol	MIN.	MAX.	Unit	Remark
Supply Voltage	VDD	-0.3	+4.0	V	
Input Signals Voltage	V _{IN}	-0.3	VDD+0.3	V	Note 6-1
Backlight Driving Voltage	V _L	-	2000	V	
Backlight Driving Frequency	F _L	0	100	KHz	
Storage Temperature	T _{ST}	-20	+70	°C	Note 6-2
Operating Temperature	T _{OP}	0	+60	°C	

Note 6-1: LVDS signal

Note 6-2: Humidity : 90% RH Max. at Ta ≤ 40

Maximum wet-bulb temperature is at 39, or less at Ta > 40, and no condensation.

7. Electrical Characteristics

7-1) Recommended Operating Conditions:

GND = 0V, Ta = 25°C

Item	Symbol	Min.	Typ.	Max.	Unit	Remark
Supply Voltage	VDD	3.0	3.3	3.6	V	
Current Dissipation	I _{DD}	-	350	450	mA	Note 7-1
LVDS Differential input high threshold	V _{TH}	-	-	100	mV	Note 7-2
LVDS Differential input low threshold	V _{TL}	-100	-	-		
Lamp Current	I _{FL}	3.0	5.0	6.0	mA	5mA : 160 cd/m ² Note 7-3 Note 7-5
Lamp Voltage	V _L	500	550	600	V _{rms}	I _{FL} =5mA Note 7-3
Lamp Initial Voltage	V _{SFL}	-	1200	-	V _{rms}	at Ta=25°C
		1000				at Ta=0°C
Lamp Driving Frequency	F _L	-	45	-	KHz	
Total power consumption (at I _{FL} =5mA)		--	3.91	-	W	Note 7-4

Note 7-1: To test the current dissipation of VDD, using the "color bars" testing pattern shown as below.

1	2	3	4	5	6	7	8
---	---	---	---	---	---	---	---

1. White
2. Yellow
3. Cyan
4. Green
5. Magenta
6. Red
7. Blue
8. Black

I_{DD} current dissipation testing pattern

Note 7-2: Please refer to DS90CF364 specification by National Semiconductor Corporation.

This LCD module conforms to LVDS standard.

Note 7-3: The back-light driving waveform should be as close to sine-wave as possible.

In order to satisfy the quality of B/L, no matter what kind of inverter, the output lamp current must be between Min. and Max. to avoid the abnormal display image caused by B/L.

Note 7-4: Not including the efficiency of backlight DC/AC inverter

Note 7-5: Lamp current is measured with current meter for high frequency as shown below

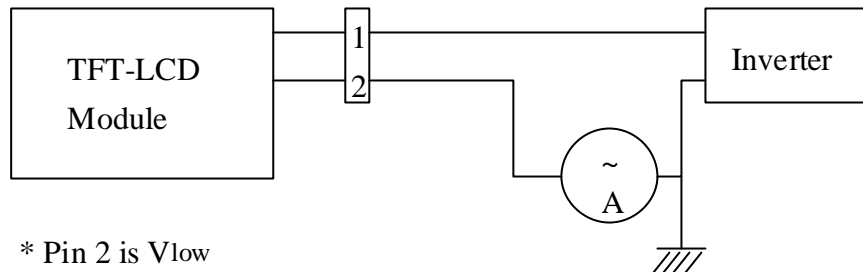

* Pin 2 is V_{low}

** Current meter :
Yokogawa 2016-01

Lamp current dissipation testing configuration

7-2) Input / Output signal timing chart

(A) Vertical Timing

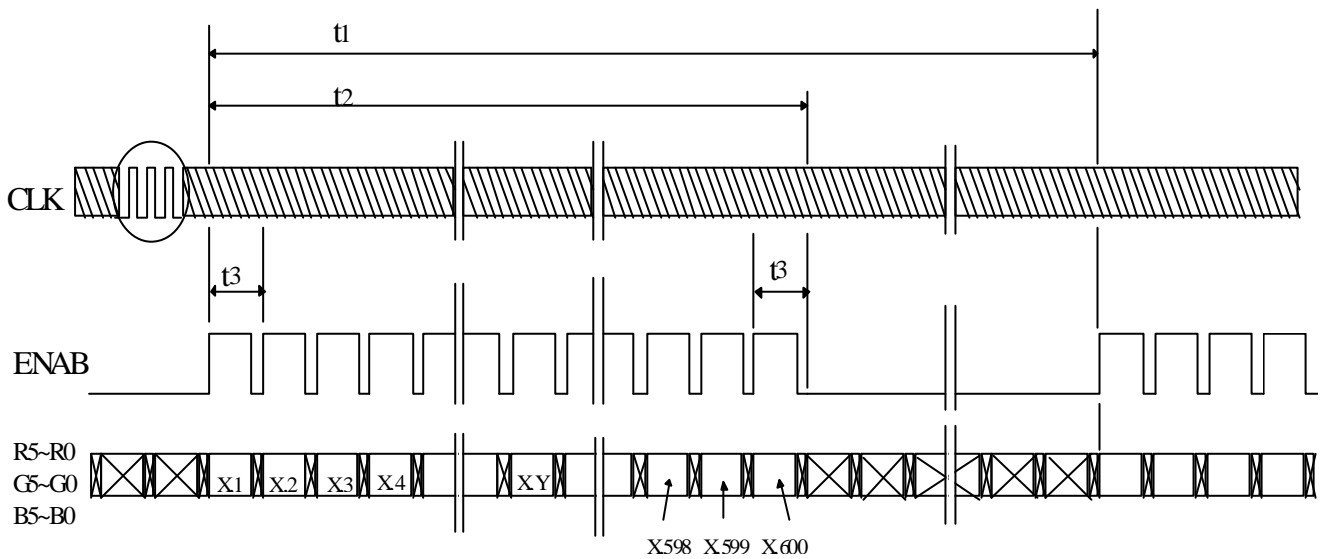

(B) Horizontal Timing

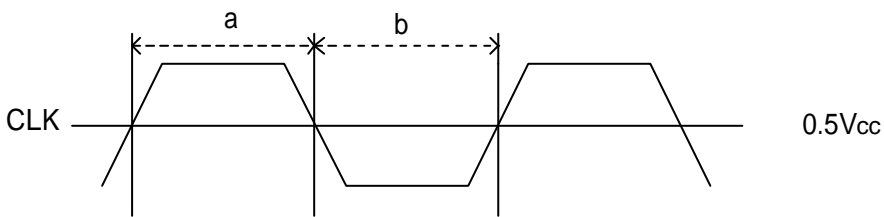
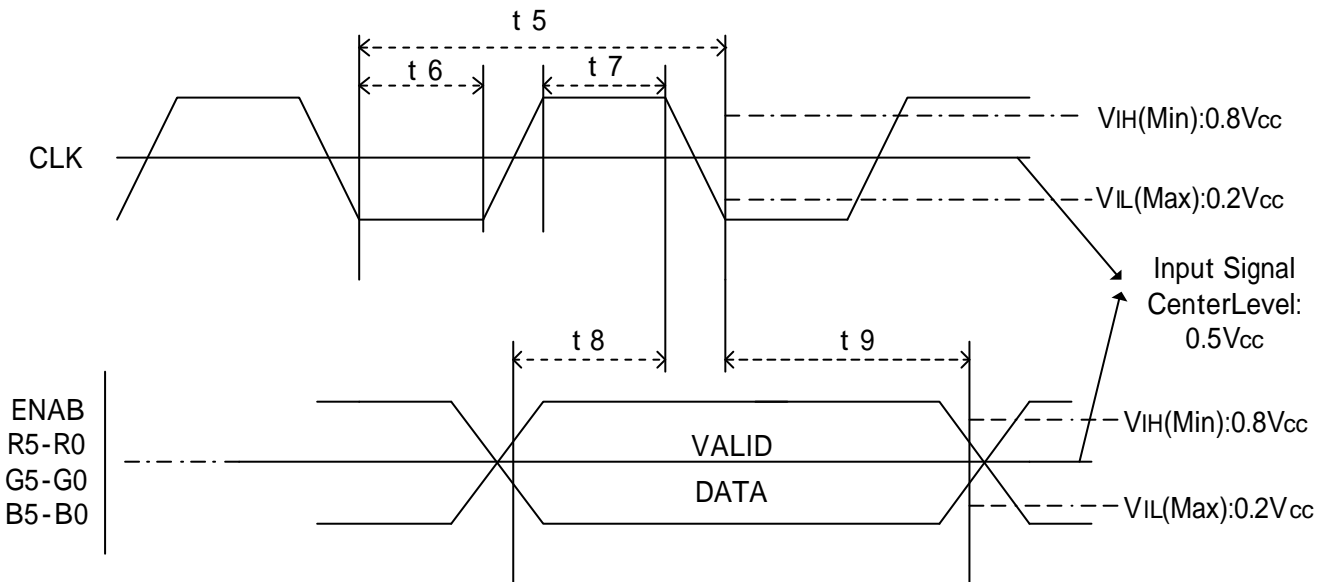
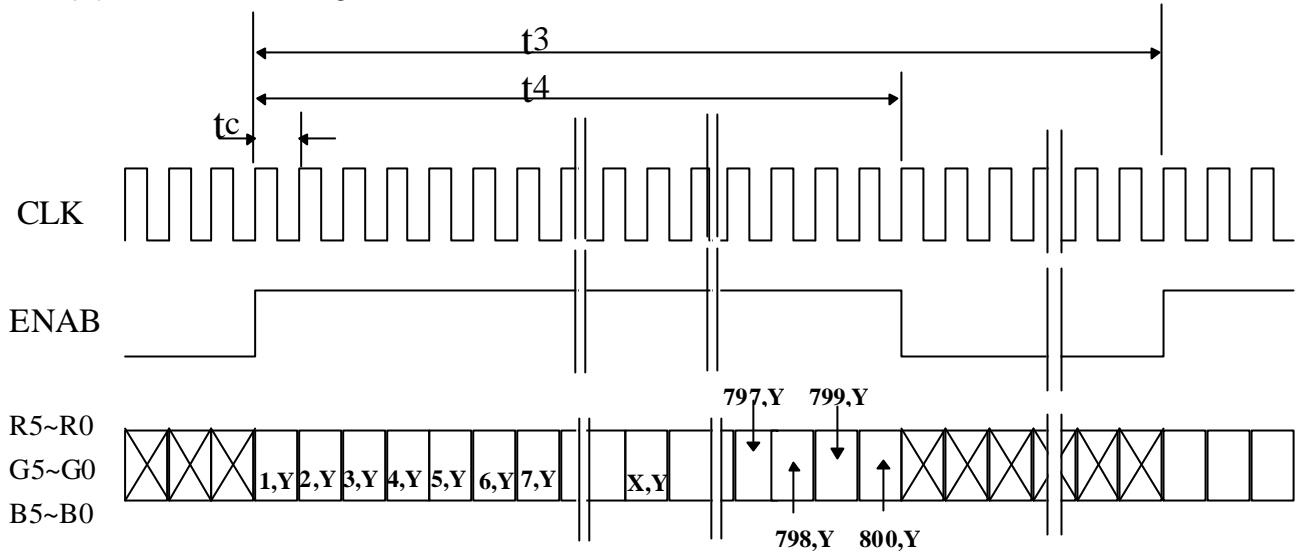

Duty (a, b) $50 \pm 10\%$

D) Timing Specifications

Item	Symbol	Min.	Typ.	Max.	Unit	Remark
Frame Cycling	t1	604×t3	628×t3	660×t3	-	
		-	16.58	17.86	ms	
Vertical Display Period	t2	600×t3	600×t3	600×t3	-	
Horizontal Scanning Time	t3	844×t5	1056×t5	1064×t5	-	
		26.3	26.4	-	μs	
Horizontal Display Period	t4	-	800×t5	-	-	
Clock Cycle	t5	24.0	25.0	-	ns	
Clock High Level Time	t6	9.0	-	-	ns	
Clock Low Level Time	t7	9.0	-	-	ns	
Hold time	t8	4.0	-	-	ns	
Set-up time	t9	5.0	-	-	ns	

7-3) Display Color and Gray Scale Reference

Color		Input Color Data																	
		Red						Green						Blue					
		R5	R4	R3	R2	R1	R0	G5	G4	G3	G2	G1	G0	B5	B4	B3	B2	B1	B0
Basic Colors	Black	0	0	0	0	0	0	0	0	0	0	0	0	0	0	0	0	0	0
	Red (63)	1	1	1	1	1	1	0	0	0	0	0	0	0	0	0	0	0	0
	Green (63)	0	0	0	0	0	0	1	1	1	1	1	1	0	0	0	0	0	0
	Blue (63)	0	0	0	0	0	0	0	0	0	0	0	0	1	1	1	1	1	1
	Cyan	0	0	0	0	0	0	1	1	1	1	1	1	1	1	1	1	1	1
	Magenta	1	1	1	1	1	1	0	0	0	0	0	0	1	1	1	1	1	1
	Yellow	1	1	1	1	1	1	1	1	1	1	1	1	0	0	0	0	0	0
	White	1	1	1	1	1	1	1	1	1	1	1	1	1	1	1	1	1	1
Red	Red (00)	0	0	0	0	0	0	0	0	0	0	0	0	0	0	0	0	0	0
	Red (01)	0	0	0	0	0	1	0	0	0	0	0	0	0	0	0	0	0	0
	Red (02)	0	0	0	0	1	0	0	0	0	0	0	0	0	0	0	0	0	0
	Darker																		
	↓	↓	↓	↓	↓	↓	↓	↓	↓	↓	↓	↓	↓	↓	↓	↓	↓	↓	↓
	Brighter																		
	Red (61)	1	1	1	1	0	1	0	0	0	0	0	0	0	0	0	0	0	0
	Red (62)	1	1	1	1	1	0	0	0	0	0	0	0	0	0	0	0	0	0
Red (63)	1	1	1	1	1	1	0	0	0	0	0	0	0	0	0	0	0	0	
Green	Green (00)	0	0	0	0	0	0	0	0	0	0	0	0	0	0	0	0	0	0
	Green (01)	0	0	0	0	0	0	0	0	0	0	0	1	0	0	0	0	0	0
	Green (02)	0	0	0	0	0	0	0	0	0	0	1	0	0	0	0	0	0	0
	Darker																		
	↓	↓	↓	↓	↓	↓	↓	↓	↓	↓	↓	↓	↓	↓	↓	↓	↓	↓	↓
	Brighter																		
	Green (61)	0	0	0	0	0	0	1	1	1	1	0	1	0	0	0	0	0	0
	Green (62)	0	0	0	0	0	0	1	1	1	1	1	0	0	0	0	0	0	0
Green (63)	0	0	0	0	0	0	1	1	1	1	1	1	0	0	0	0	0	0	
Blue	Blue (00)	0	0	0	0	0	0	0	0	0	0	0	0	0	0	0	0	0	0
	Blue (01)	0	0	0	0	0	0	0	0	0	0	0	0	0	0	0	0	0	1
	Blue (02)	0	0	0	0	0	0	0	0	0	0	0	0	0	0	0	0	1	0
	Darker																		
	↓	↓	↓	↓	↓	↓	↓	↓	↓	↓	↓	↓	↓	↓	↓	↓	↓	↓	↓
	Brighter																		
	Blue (61)	0	0	0	0	0	0	0	0	0	0	0	0	1	1	1	1	0	1
	Blue (62)	0	0	0	0	0	0	0	0	0	0	0	0	1	1	1	1	1	0
Blue (63)	0	0	0	0	0	0	0	0	0	0	0	0	1	1	1	1	1	1	

7-4) Pixel Arrangement

The LCD module pixel arrangement is the stripe.

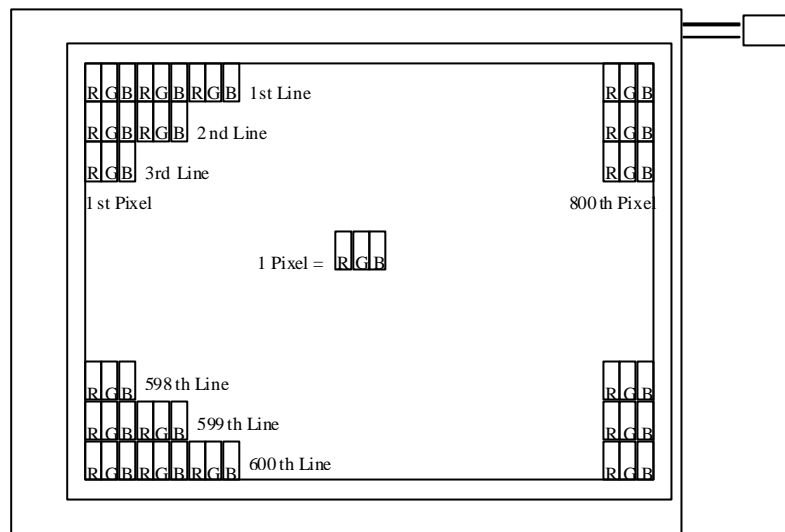

8. Power On Sequence

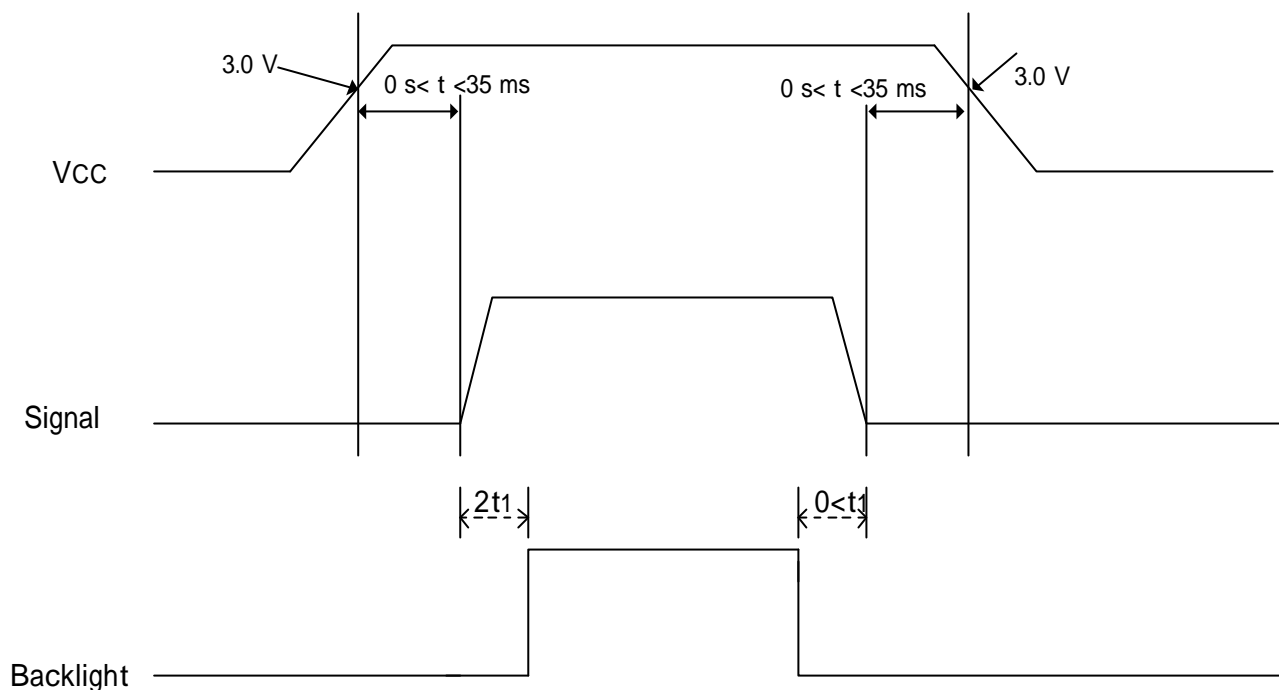

1. The supply voltage for input signals should be same as V_{CC} .
2. When the power is off , please keep whole signals (Hsync, Vsync, CLK, Data) low level or high impedance

9. Optical Characteristics

9-1) Specification:

Ta = 25°C

Parameter	Symbol	Condition	MIN.	TYP.	MAX.	Unit	Remarks
Viewing Angle	Horizontal	θ	± 35	± 45	-	deg	Note 9-1
	Vertical	θ (to 12 o'clock)	10	15	-	deg	
		θ (to 6 o'clock)	25	40	-	deg	
Contrast Ratio	CR	Optimum direction	100	180	-	-	Note 9-2
Response time	Rise	Tr	-	15	50	ms	Note 9-4
	Fall	Tf	-	25	50	ms	
Luminance	L	$\theta=0^\circ/\varphi=0^\circ$	130	160	-	cd/m ²	I _{FL} =5mA, Note 9-3
Luminance Uniformity	U		55	80	-	%	Note 9-5
White Chromaticity	x		0.260	0.310	0.360	-	
	y		0.290	0.340	0.390	-	
	Tc		6400	6600	6800	K	
Lamp Life Time			30000	40000	-	hr	I _{FL} =5mA
Cross Talk Ratio	CTK		-	-	3.5	%	Note 9-6

All the optical measurement shall be executed 30 minutes after backlight being turn-on. The optical characteristics shall be measured in dark room (ambient illumination on panel surface less than 1 Lux). The measuring configuration shows as following figure.

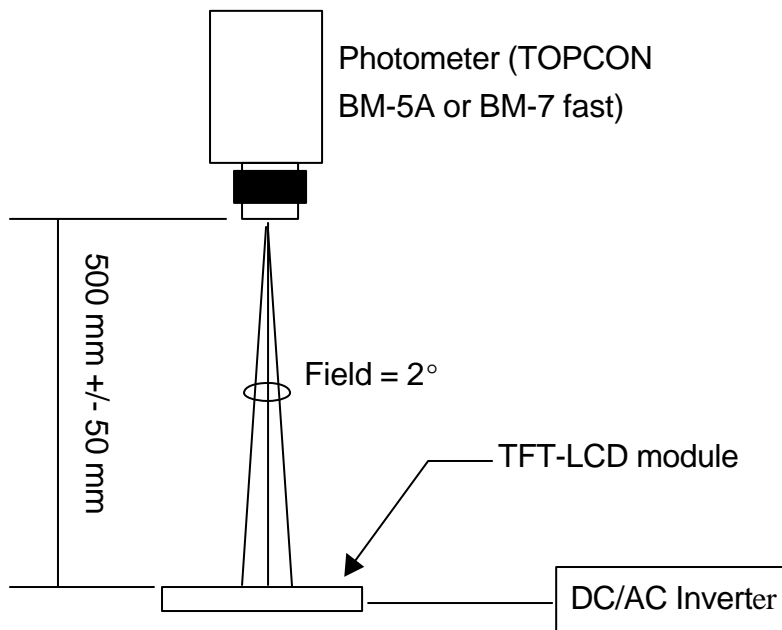

Optical characteristics measuring configuration

Note 9-1': The definitions of viewing angles are as follows.

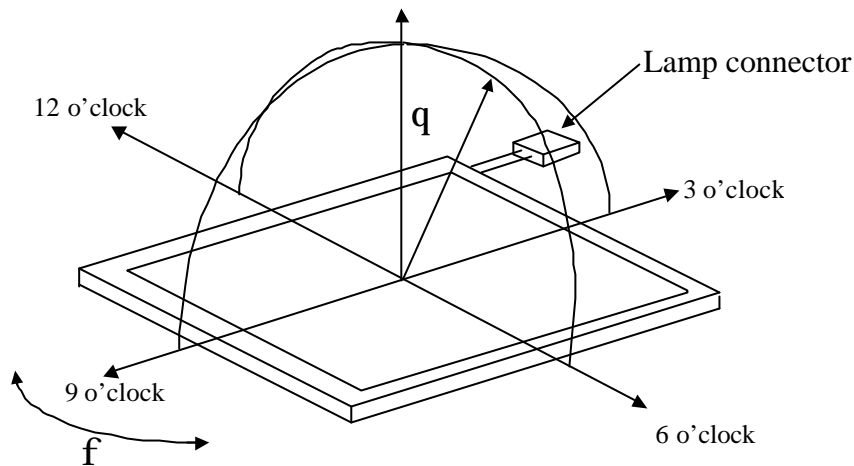

Note 9-2: The definition of contrast ratio $CR = \frac{\text{Luminance at gray level 63}}{\text{Luminance at gray level 0}}$

Note 9-3: Topcon BM-5A luminance meter 2° field of view is used in the testing (after 30 minutes' operation). The typical luminance value is measured at lamp current 3.0 mA. The max luminance value is measured at lamp current 6.0 mA.

Note 9-4: Definition of Response Time T_r and T_f :

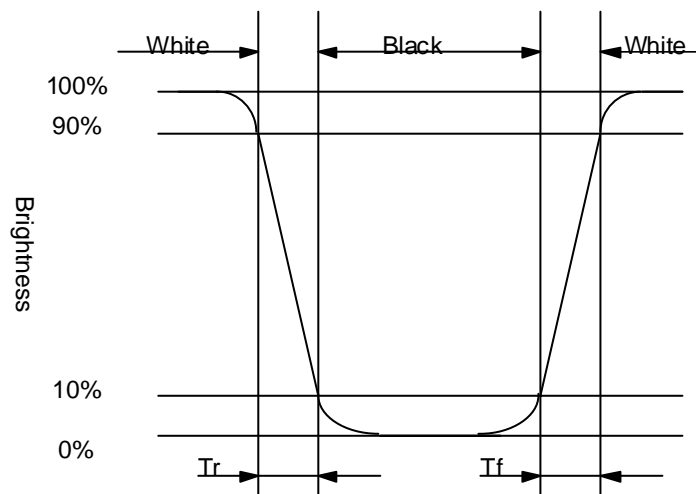

Note 9-5: The uniformity of LCD is defined as

$$U = \frac{\text{The Minimum Brightness of the 9 testing Points}}{\text{The Maximum Brightness of the 9 testing Points}}$$

Luminance meter : BM-5A or BM-7 fast(TOPCON)

Measurement distance : 500 mm +/- 50 mm

Ambient illumination : < 1 Lux

Measuring direction : Perpendicular to the surface of module

The test pattern is white (Gray Level 63).

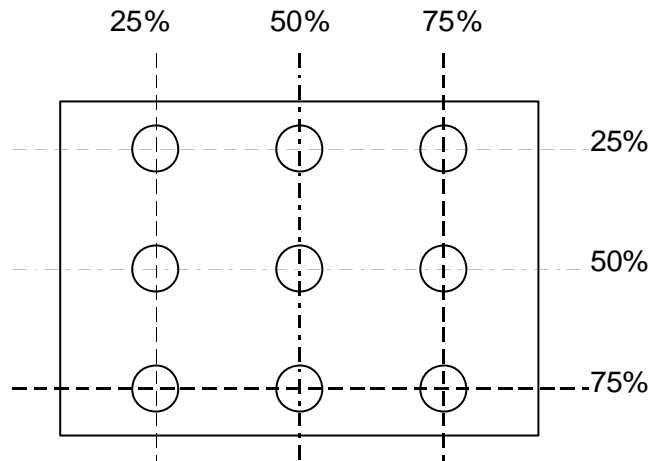

Note 8-6: Cross Talk (CTK) = $\frac{|YA-YB|}{YA} \times 100\%$

YA: Brightness of Pattern A

YB: Brightness of Pattern B

Luminance meter: BM 5A (TOPCON)

Measurement distance: 500 mm +/- 50 mm

Ambient illumination: < 1 Lux

Measuring direction: Perpendicular to the surface of module

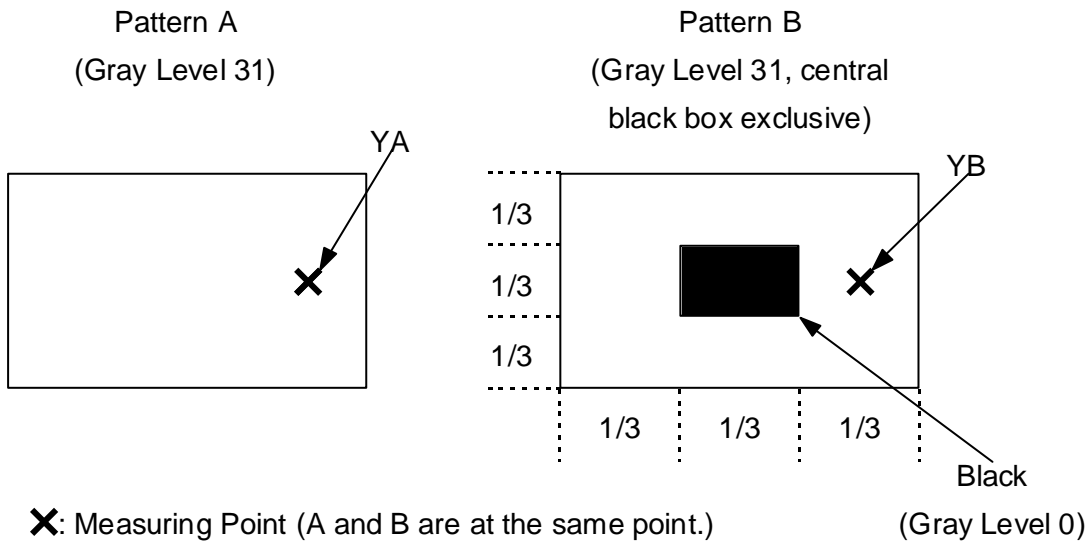

10. Handling Cautions

10-1) Mounting of module

- a) Please power off the module when you connect the input/output connector.
- b) Please connect the ground pattern of the inverter circuit surely. If the connection is not perfect, some following problems may happen possibly.
 - 1. The noise from the backlight unit will increase.
 - 2. The output from inverter circuit will be unstable.
 - 3. In some cases a part of module will heat.
- c) Polarizer which is made of soft material and susceptible to flaw must be handled carefully.
- d) Protective film (Laminator) is applied on surface to protect it against scratches and dirt. It is recommended to peel off the laminator before use and taking care of static electricity.

10-2) Precautions in mounting

- a) When metal part of the TFT-LCD module (shielding lid and rear case) is soiled, wipe it with soft dry cloth.
- b) Wipe off water drops or finger grease immediately. Long contact with water may cause discoloration or spots.
- c) TFT-LCD module uses glass which breaks or cracks easily if dropped or bumped on hard surface. Please handle with care.
- d) Since CMOS LSI is used in the module. So take care of static electricity and earth yourself when handling.

10-3) Adjusting module

- a) Adjusting volumes on the rear face of the module have been set optimally before shipment.
- b) Therefore, do not change any adjusted values. If adjusted values are changed, the specifications described may not be satisfied.

10-4) Others

- a) Do not expose the module to direct sunlight or intensive ultraviolet rays for many hours.
- b) Store the module at a room temperature place.
- c) The voltage of beginning electric discharge may over the normal voltage because of leakage current from approach conductor by to draw lump read lead line around.
- d) If LCD panel breaks, it is possibly that the liquid crystal escapes from the panel. Avoid putting it into eyes or mouth. When liquid crystal sticks on hands, clothes or feet. Wash it out immediately with soap.
- e) Observe all other precautionary requirements in handling general electronic components.
- f) Please adjust the voltage of common electrode as material of attachment by 1 module.

11. Reliability Test

No	Test Item	Test Condition	Remark
1	High Temperature Storage Test	Ta = +70°C, 240 hrs	
2	Low Temperature Storage Test	Ta = -20°C, 240 hrs	
3	Low Temperature Operation Test	Ta = 0°C, 240 hrs	
4	High Temperature & High Humidity Operation Test	Ta = +60°C, 80%RH, 240 hrs (No Condensation)	
5	Thermal Cycling Test (non-operating)	0°C ↔ +25°C ↔ +60°C, 50 Cycles 1Hr 0.5Hr 1Hr	
6	Vibration Test (non-operating)	Frequency:10~57 Hz, Amplitude: 0.15 mm 58~500Hz, 1G Sweep time: 11 min Test Period: 3 hrs(1 hr for each direction of X, Y, Z)	
7	Shock Test (non-operating)	80G, 6ms, X,Y, Z 1 times for each direction	

Ta: ambient temperature

[Judgement Criteria]

Under the display quality test conditions with normal operation state , there should be no change which may affect practical display function.

12. Indication of Label

a) Indicated contents of the label

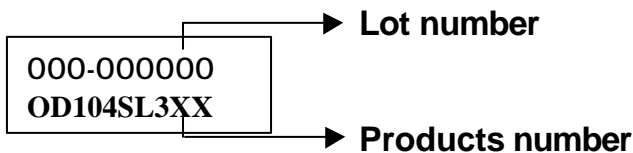

Contents of lot number : 1st—Process area : class 1000 ⇒ H
class 100K ⇒ M

2nd~3rd—Module screen size(in inch) : 1.8"⇒18, 2.5"⇒25.....
5th—Production year : 1999⇒9, 2000⇒A, 2001⇒1.....
6th—Production month : 1, 2, 3,.....9, A, B, C
7th~10th—Serial numbers : 0001~9999

b) Indicated contents of the Product number label

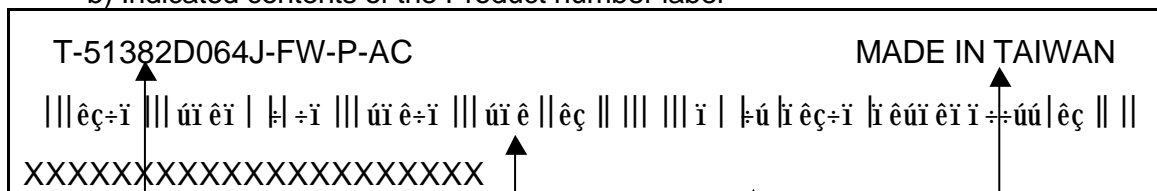

Module Name of Optrex

Ex. T-51382D064J-FW-P-AC

Barcode Symbol

Barcode Number

Production Country

The Module Manufacture Location

T-51410D104J-FW-P-AC (AC) No. 2002-0203	OPTREX CORPORATION	Page 17/25
---	--------------------	------------

13. Block Diagram

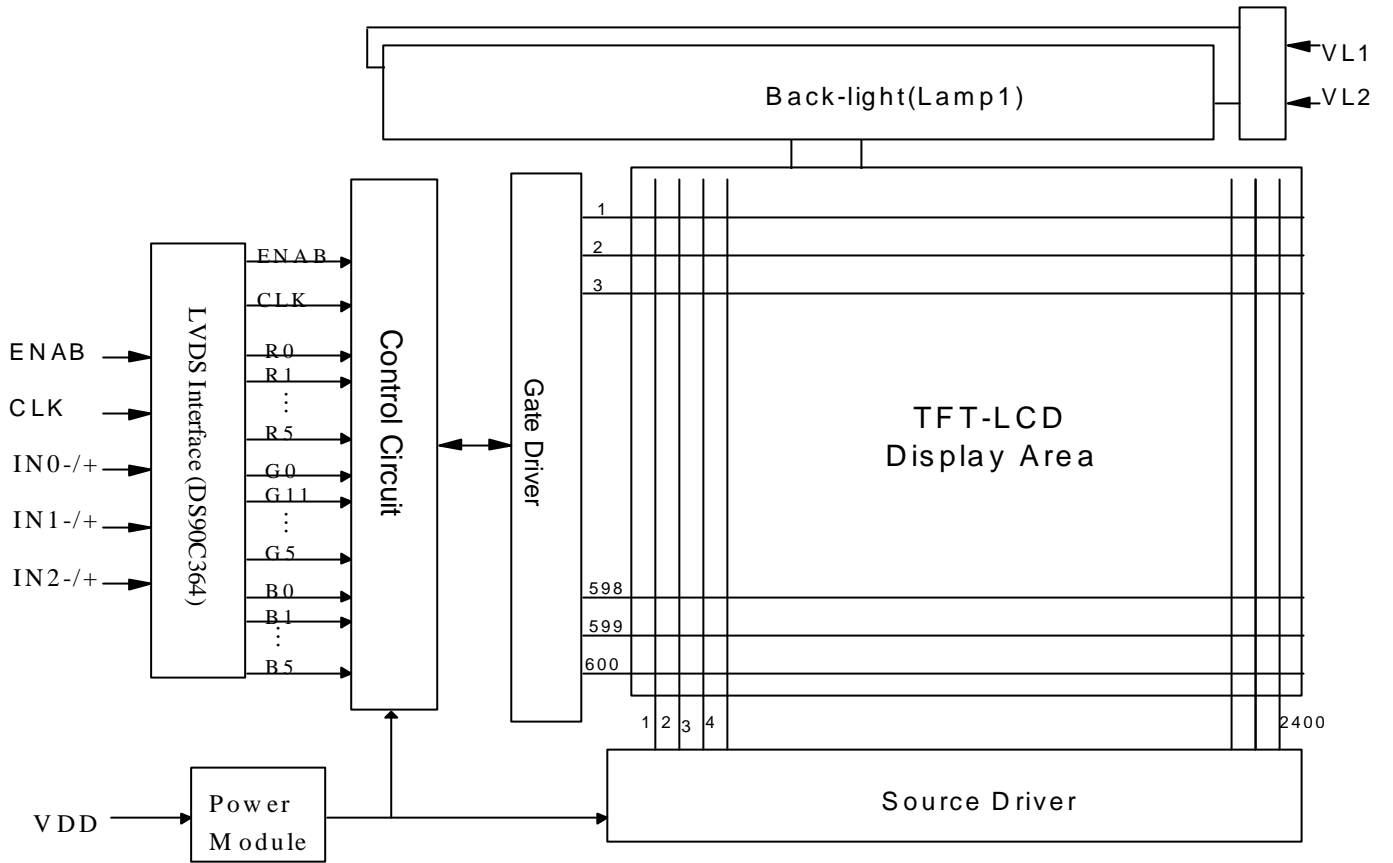

14. Standard

14-1) Inspection condition

Viewing Angle (Major axis x)

$\theta < 45^\circ$ inspection under non-operating condition

$\theta < 5^\circ$ inspection under operating condition

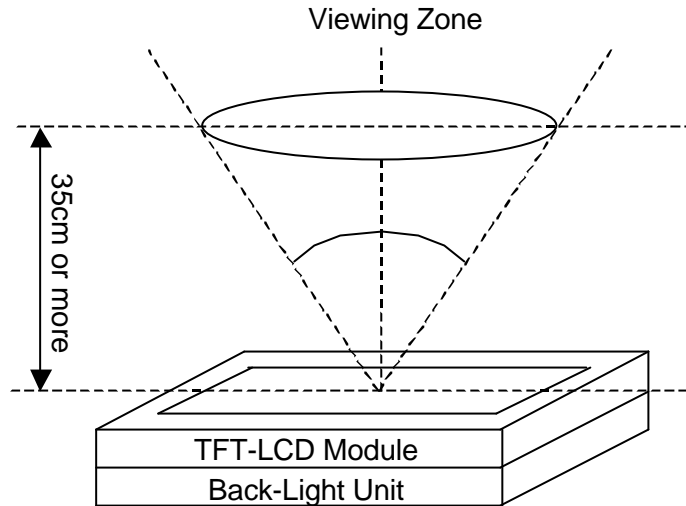

14-2) Environment condition

- Ambient Temperature: $25^\circ\text{C} \pm 5^\circ\text{C}$
- Ambient Humidity: $65 \pm 5\% \text{RH}$
- Ambient Luminance: 20 watts fluorescent lamp (about 500 lux)

14-3) Sampling condition

Unless otherwise agreed in written, the sampling inspection shall be applied to the incoming inspection of customer.

- Lot size: Quantity of shipment lot per model.
- Sampling type: Normal inspection, single sampling
- Sampling Level: Level II
- Sampling table: ISO 2859 (Also known as MIL-STD-105E).

14-4) Acceptance Quality Level (AQL)

The AQL for major and minor defects is defined as follows:

- Major defect: 0.65%
- Minor defect: 1.5%

14-5) Classification of defects

Defects and classified as either a major or minor defect defined as bellows:

- Major defect:

It is a defect that is likely to result in failure or to reduce materially the usability of the product for the intended function.

- Minor defect:

It is a defect that will not result in functioning problem with deviation classified.

14-6) Inspection Instrument:

- DC Power supply: DC 12V
- Luminance color meter: Topcon BM –7
- Others: Micrometer, Microscope, and Caliper.

14-7) Cosmetic Specification

Item	Specification/Description	Classification	Note									
Display Inspection (operating)	Display function	No Display Malfunction	Major									
	Flickering	Visible at display area	Minor									
	Contrast ratio (Black, White)	Does not meet specified range in the spec.	Major									
	Line defect	Vertical and Horizontal Line defect in bright, dark	Major									
	Point defect (Red, Green, Blue, Dark)	<table border="1"> <thead> <tr> <th>Item</th> <th>Number</th> <th>Total</th> </tr> </thead> <tbody> <tr> <td>Bright (Green)</td> <td>3</td> <td rowspan="2">10</td> </tr> <tr> <td>Bright</td> <td>10</td> </tr> </tbody> </table>	Item	Number	Total	Bright (Green)	3	10	Bright	10	Minor	1
		Item	Number	Total								
		Bright (Green)	3	10								
Bright	10											
Image retention	After displaying fixed pattern for 30 minutes, the afterimage is visible after 10 seconds.	Minor										
Non-uniformity	Visible through 2 % ND Filter.	Minor										
External Inspection (non-operating)	Dimension	Outline	Major									
	Bezel appearance	Out of mechanical spec regarding bending area.	Minor									
	Scratch on the polarizer	N=5 max ($W \leq 0.1$ or $L \leq 10$) N=0 ($W > 0.1$ or $L > 10$)	Minor	2								
	Dent or Bubble on the polarizer (in available viewing area)	N=5 max ($W \leq 0.5$ and $L \leq 10$) N=0 ($W > 0.5$ or $L > 1.0$)	Minor	2								
	Foreign material on polarizer	($W > 1/4L$) N=4 max ($0.1L < D \leq 0.4$) N disregard ($W \leq 1/4L$) N=4 max ($0.03 < W \leq 0.10$ and $0.3 < L \leq 2.1$) N=0 ($W > 0.1$ or $L > 2.1$)	Minor	3								
	Plastic frame	Break or modification	Minor	2								
	Wrinkle on polarizer	Serious wrinkle is not allowed										

	Cable	The metal wire is exposed	Minor	2
	Connector (signal input)	Break	Major	
<p>(W-Width in mm, L-Length in mm, N-Number, D-Average Diameter in mm,) Remark: Major: Defect that is likely to result in failure or to reduce materially the usability of the product for the intended function. Minor: Defect that will not result in functioning problem with deviation as classified.</p>				

- Note: 1. (a) Bright point defect is defined as point defect of R, G, B with area $>1/2$ pixel
Respectively and is not visible by using 5% ND filter.
- (b) Definition of distribution of point defect is as follows:
within 20mm diameter, it is allowed 4 dark points or 3 bright and dark points max.
- (c) Definition of joined bright point defect is as follows:
-Three joined bright point must be nil.
-Joined bright point is 3 pairs maximum.
- (d) Definition of joined dark point defect is as follows:
-Three jointed dark point must be nil.
-Coupling of one dark and one bright point in junction is counted as one dark and one bright spot.
-Two dark point in junction is counted as one dark point.

Note: 2. The external inspection is conducted at the distance 30cm minimum between the eyes of inspector and the panel. The inspection area is defined as full screen.

Note: 3. W: Width of foreign material

L: Length of foreign material (Take larger value of L_1 and L_2)

4A:

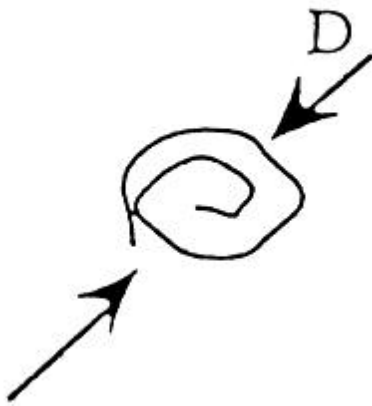

15. Packing

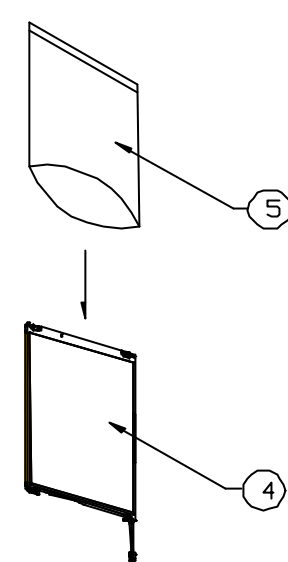
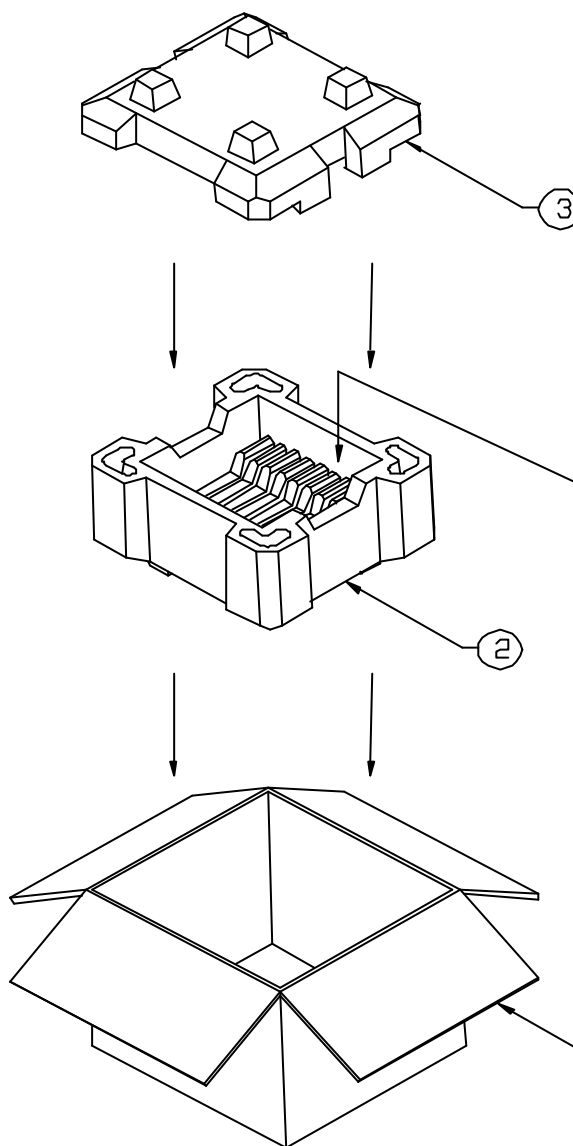

1. 先將成品電源線裝好放入防靜電袋中, 再將防靜電袋向袋口方向膠帶黏合.
2. 再以電源線線材的方向插入下層衝材的溝槽裡
3. 裝入10pcs 成品後, 再裝上上蓋衝材.
4. 最後將carton封箱貼好膠帶即可.

5	50-D500061	防靜電袋 PINK 180*340	10	
4		10.4" Module	10	
3	50-D300291	PP 衝材 底座 104	1	
2	50-D300301	PP 衝材 上蓋 104	1	
1	50-D100151	CARTON 320*285*335	1	
ITEM	PART NO.	DESCRIPTION	QTY	REMARK

MTL SPEC		UNSPECIFIED TOL'S		REMARK					
		ANGLE							
		ROUGHNESS							
APPROVE			SCALE	UNIT	SHEET	DWG TITLE			
CHECK					OF	10.4" PACKING			
DESIGN	莊孟儒	04.02.00'	MTL.NO.		DWG.NO.		REV.	A ₄	SIZE
							01		

Revision History

Rev.	Issued Date	Revised Content
1.0	Apr. 03, 2002	New
1.1	Jun. 03, 2002	Add Page 18 : Indication of Lot Number Label