

# Thyristors

## T150



### Technical Data

Typical applications : D.C. Motor control, Controlled rectifiers, A.C. Controllers

Type No.	V <sub>RRM</sub> (Volts)	V <sub>RSM</sub> (Volts)
T150/04	400	500
T150/06	600	700
T150/08	800	900
T150/10	1000	1100
T150/12	1200	1300
T150/14	1400	1500
T150/16	1600	1700

### Features

- Hermetic glass to metal seal
- Voltage grade upto 1600V
- Weight 210 gm ( Approx )

Symbol	Conditions	Values
I <sub>T(AV)</sub>	Sin 180 ; T <sub>case</sub> = 85 °C	160 A
I <sub>TSM</sub>	T <sub>vj</sub> = 25 °C T <sub>vj</sub> = 130 °C	4300 A 3750 A
I <sup>2</sup> t	T <sub>vj</sub> = 25 °C T <sub>vj</sub> = 130 °C	92500 A <sup>2</sup> s 70000 A <sup>2</sup> s
I <sub>GT</sub> V <sub>GT</sub> dv/dt [di/dt] <sub>CR</sub>	T <sub>vj</sub> = 25 °C; V <sub>DRM</sub> = 5V T <sub>vj</sub> = 25 °C; V <sub>DRM</sub> = 5V T <sub>vj</sub> = 130 °C ; Voltage = 67 % V <sub>DRM</sub>	200 mA 3 V *200 V/μs 100 A/μs
V <sub>T</sub> V <sub>0</sub> R <sub>0</sub> I <sub>RRM</sub> /I <sub>DRM</sub>	T <sub>vj</sub> = 25 °C ; I <sub>T</sub> = 500A T <sub>vj</sub> = 130 °C T <sub>vj</sub> = 130 °C T <sub>vj</sub> = 130 °C	1.75 V max 1.0 V 1.5 m 50 mA
I <sub>H</sub> I <sub>L</sub>		Typ 150 mA; max. 250 mA Typ 300 mA; max. 600 mA
R <sub>th(j-c)</sub>  R <sub>th(c-h)</sub> T <sub>vj</sub> T <sub>stg</sub>	Cont. Sin 180 / rec. 120	0.16 °C/W  0.18 / 0.20 °C/W 0.03 °C/W + 130 °C -40.....+ 150 °C
Mounting torque		30 Nm
Case outline		X

\* Higher dv/dt selection available on request



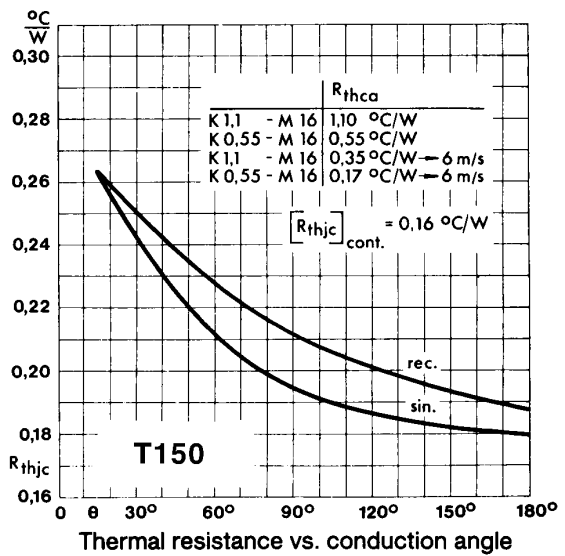
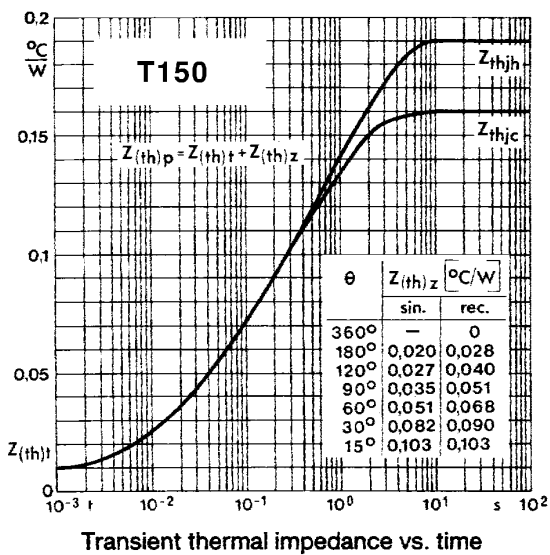
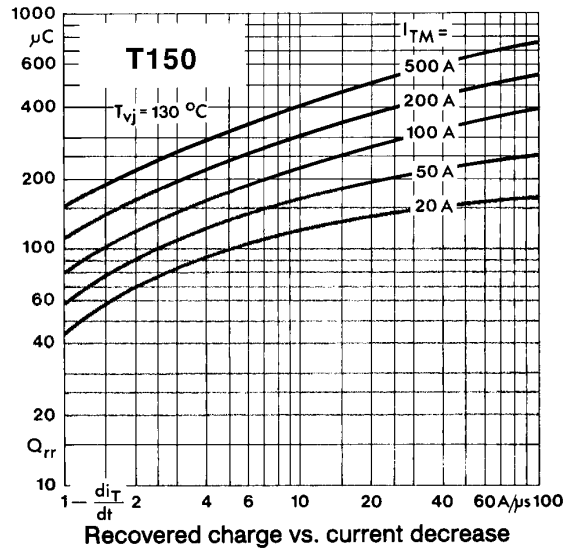
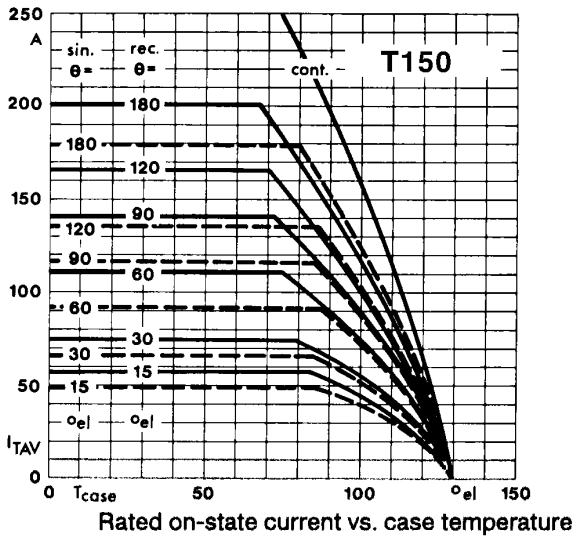
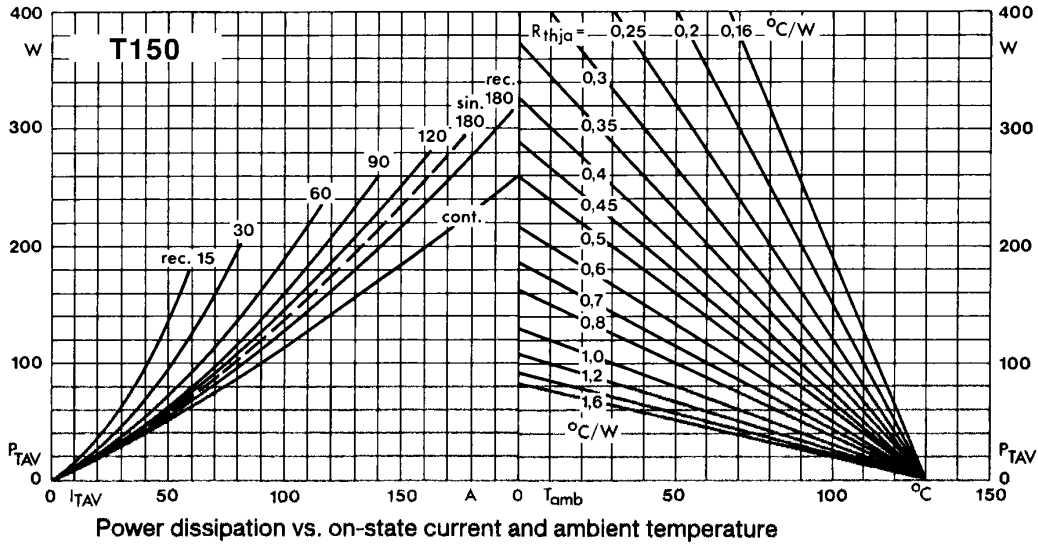

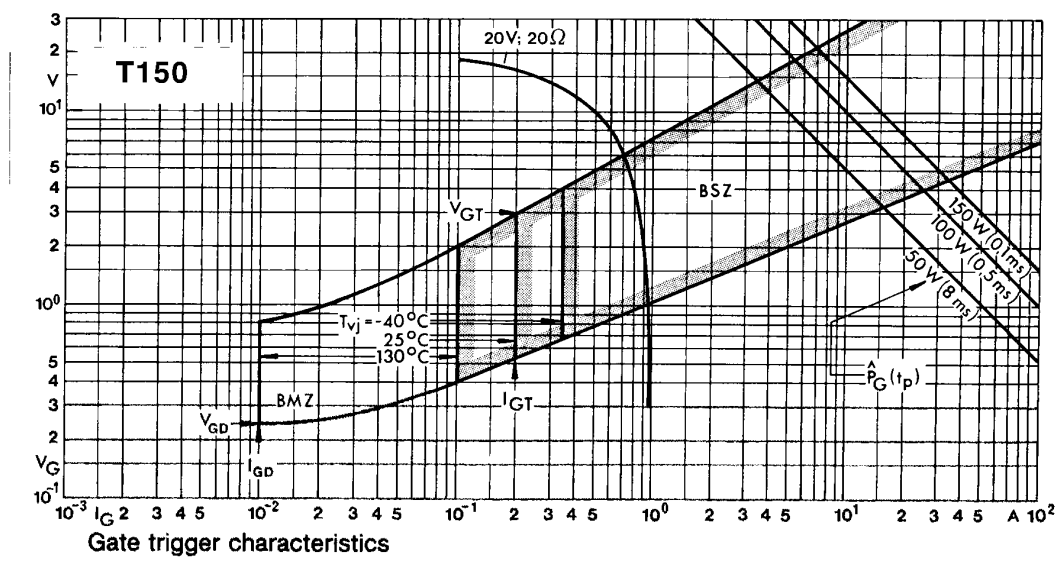
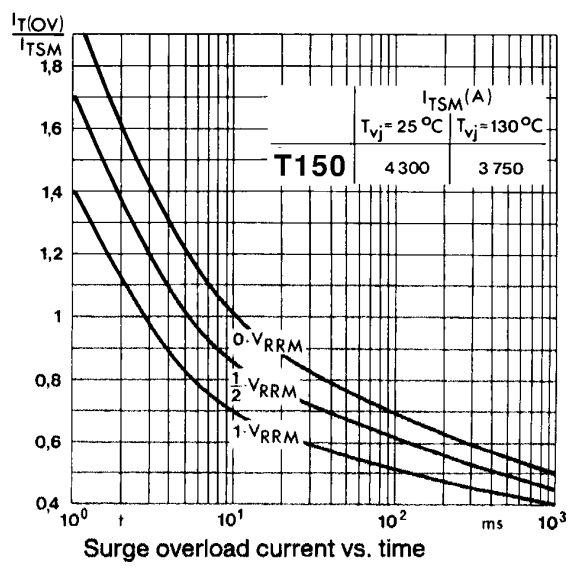
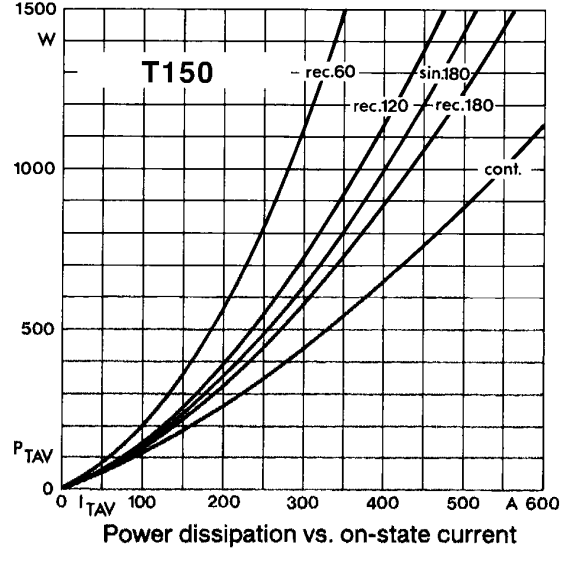
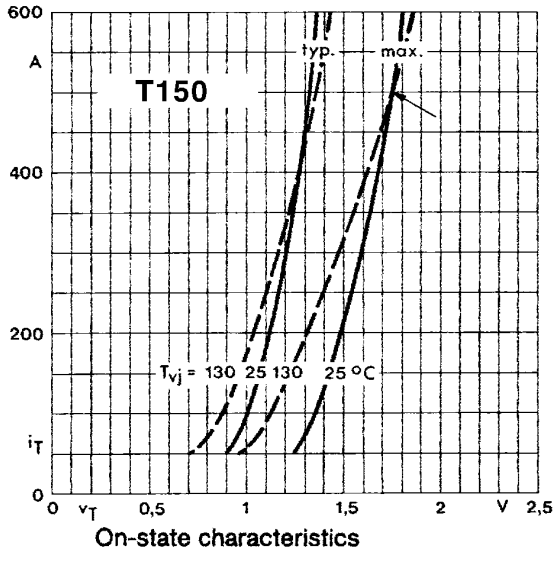

PACAKAGE DEATILS

DO NOT SCALE

All Dimensions in mm

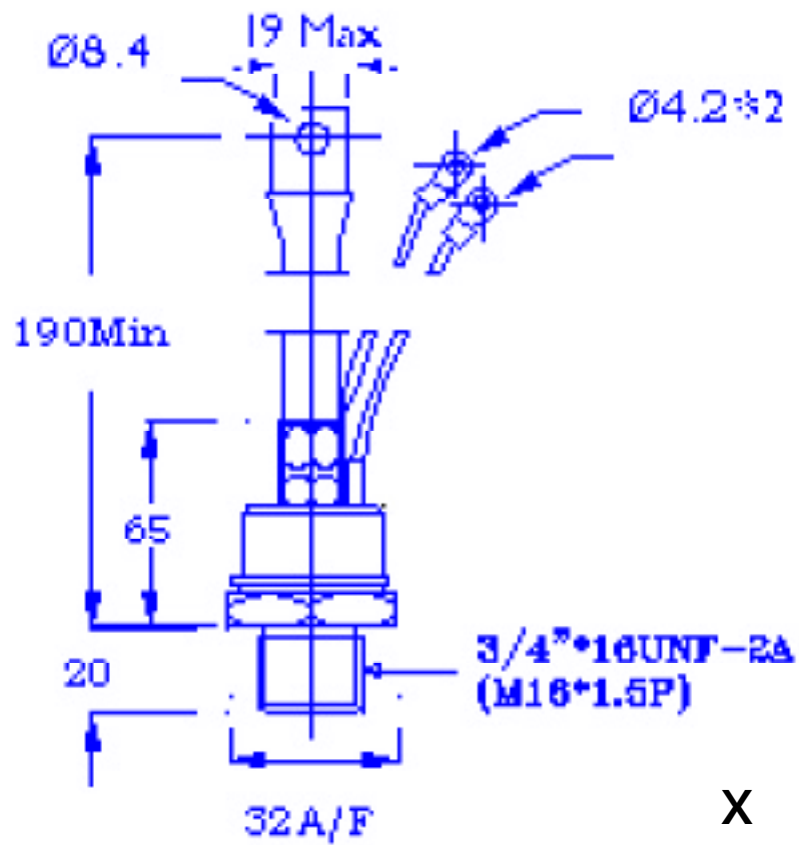

Mounting Torque : 30 Nm