

Product Overview

The T2G6001528-Q3 is an 18W (P_{3dB}) discrete GaN on SiC HEMT which operates from DC to 6.0 GHz. The device is constructed with Qorvo's proven TQGaN25 process, which features advanced field plate techniques to optimize power and efficiency at high drain bias operating conditions. This optimization can potentially lower system costs in terms of fewer amplifier line-ups and lower thermal management costs.

Lead free and RoHS compliant.

Evaluation boards are available upon request.



Key Features

- Operating Frequency Range: DC – 6.0 GHz
- Operating Drain Voltage: 28 V
- Output Power (P_{3dB}): 19 W at 5.2 GHz
- Low thermal resistance package

Functional Block Diagram

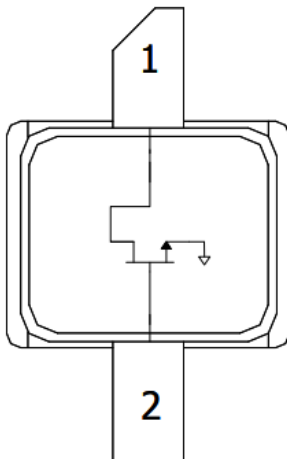

Applications

- Military Radar
- Civilian Radar
- Professional and military radio communications
- Test Instrumentation
- Wideband/Narrowband Amplifiers
- Jammers

Ordering Information

Part Number	Description
T2G6001528-Q3	Packaged Part Flangeless
T2G6001528-Q3EVB1	5.0 – 6.0 GHz Evaluation Board
T2G6001528-Q3EVB2	1.8 – 2.6 GHz Evaluation Board

Absolute Maximum Ratings

Parameter	Rating
Breakdown Voltage (V_{DGS})	+100 V
Gate Voltage Range (V_G)	-7 to +2 V
Drain Current (I_D)	5 A
Gate Current (I_G)	-5 to 14 mA
Power Dissipation (P_D)	28 W
Peak RF Input Power, CW	+36 dBm
Channel Temperature (T_{CH})	+275 °C
Mounting Temperature (30 seconds)	320 °C
Storage Temperature	-40 to +150 °C

Exceeding any one or a combination of the Absolute Maximum Rating conditions may cause permanent damage to the device. Extended application of Absolute Maximum Rating conditions to device may reduce device reliability.

Recommended Operating Conditions⁽¹⁾

Parameter	Min	Typ	Max	Units
Gate Voltage (V_G)	-	-2.9	-	V
Drain Voltage (V_D)	-	+32	-	V
Quiescent Drain Current (I_{DQ})	-	50	-	mA
Peak Drain Current (I_D)	-	1.4	-	A
Channel Temperature (T_{CH})	-	-	225	°C
Power Dissipation, CW $P_D^{(2)}$	-	-	20.9	W
Power Dissipation, Pulse $P_D^{(3)}$	-	-	22.5	W

¹ Electrical specification are measured at specified test conditions.

Specifications are not guaranteed over all recommended operating conditions.

² Package at 85 °C

³ 100uS Pulse Width, 20 % Duty Cycle, package at 85 °C

RF Characterization – Load Pull Performance at 3.0 GHz⁽¹⁾

Parameter	Min	Typ	Max	Units
Linear Gain (G_{LIN})	-	16.5	-	dB
Output Power at 3 dB Gain Compression (P_{3dB})	-	19.6	-	W
Drain Efficiency at 3 dB Gain Compression (DE_{3dB})	-	69.6	-	%
Power Added Efficiency at 3 dB Gain Compression (PAE_{3dB})	-	66.4	-	%
Gain at 3 dB Compression (G_{3dB})	-	13.5	-	dB

Notes:

1. Test conditions unless otherwise noted: $T_A = 25$ °C, $V_D = 28$ V, $I_{DQ} = 50$ mA, Pulse: 100uS, 20%

RF Characterization – Load Pull Performance at 6.0 GHz⁽¹⁾

Parameter	Min	Typ	Max	Units
Linear Gain (G_{LIN})	-	11.3	-	dB
Output Power at 3 dB Gain Compression (P_{3dB})	-	19.0	-	W
Drain Efficiency at 3 dB Gain Compression (DE_{3dB})	-	66.0	-	%
Power Added Efficiency at 3 dB Gain Compression (PAE_{3dB})	-	56.2	-	%
Gain at 3 dB Compression (G_{3dB})	-	8.3	-	dB

Notes:

1. Test conditions unless otherwise noted: $T_A = 25$ °C, $V_D = 28$ V, $I_{DQ} = 50$ mA, Pulse: 100uS, 20%

RF Characterization – Performance at 5.2 GHz^(1,2)

Parameter	Min	Typ	Max	Units
Linear Gain (G_{LIN})	-	10.5	-	dB
Output Power at 3 dB Gain Compression (P_{3dB})	-	17.3	-	W
Drain Efficiency at 3 dB Gain Compression (DE_{3dB})	-	48.0	-	%
Gain at 3 dB Compression (G_{3dB})	-	7.5	-	dB
Gate Leakage, $V_D = 10$ V, $V_G = -3.7$ V	-5.5	-	-	mA

Notes:

1. Performance at 5.2 GHz in the 5.0 - 6.0 GHz Evaluation Board
2. Test conditions unless otherwise noted: $T_A = 25$ °C, $V_D = 28$ V, $I_{DQ} = 50$ mA, Pulse: 100uS, 20%

RF Characterization – Mismatch Ruggedness at 3.50 GHz^(1,2)

Symbol	Parameter	dB Compression	Typical
VSWR	Impedance Mismatch Ruggedness	1	10:1

Notes:

1. Test conditions unless otherwise noted: $T_A = +25$ °C, $V_D = +28$ V, $I_{DQ} = 50$ mA
2. $V_{DS} = 28$ V, $I_{DQ} = 50$ mA, CW at P_{1dB}

Thermal Information^(1,2)

Parameter	Test Conditions	Values	Units
Thermal Resistance	$P_{DISS} = 22.5$ W, Pulse Width = 100 μ s	3.2	°C/W
Channel Temperature	Duty Cycle = 20%, $T_{CASE} = 85$ °C	156.8	°C

Notes:

1. Thermal resistance is measured to package backside.
2. Refer to the following document: [GaN Device Channel Temperature, Thermal Resistance, and Reliability Estimates](#)

Maximum Channel Temperature

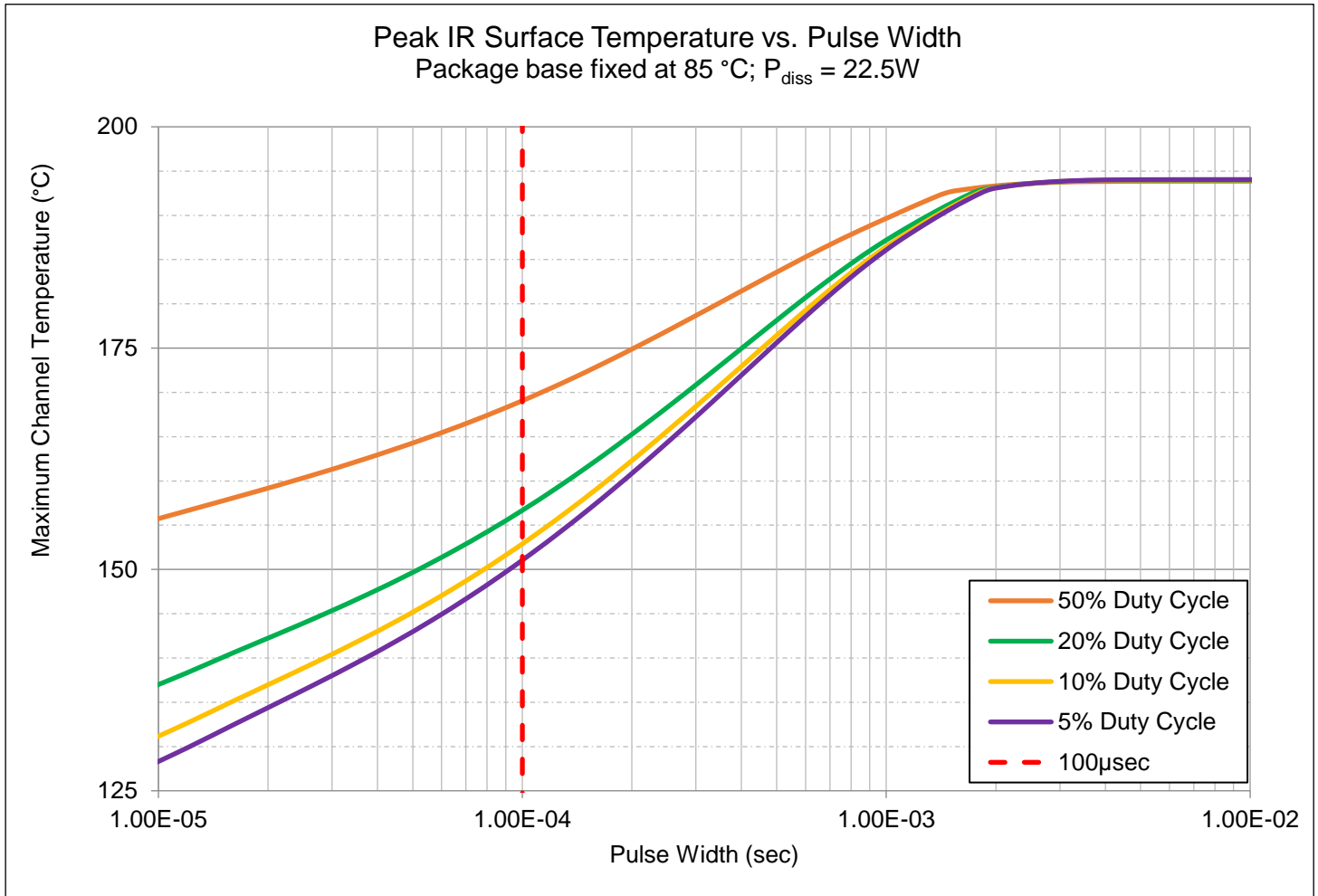

Load Pull Contours^(1,2,3,4,5)

Notes:

1. The impedances shown are those presented to the device at load pull reference planes. See page 13.
2. Test Conditions: $V_{DS} = 28\text{ V}$, $I_{DQ} = 50\text{ mA}$
3. Test Signal: Pulse Width = 100 μsec , Duty Cycle = 20%
4. NaN indicates the value was not set during load pull.
5. Z_0 is the characteristic impedance of load pull fixtures.

3GHz, Load-pull

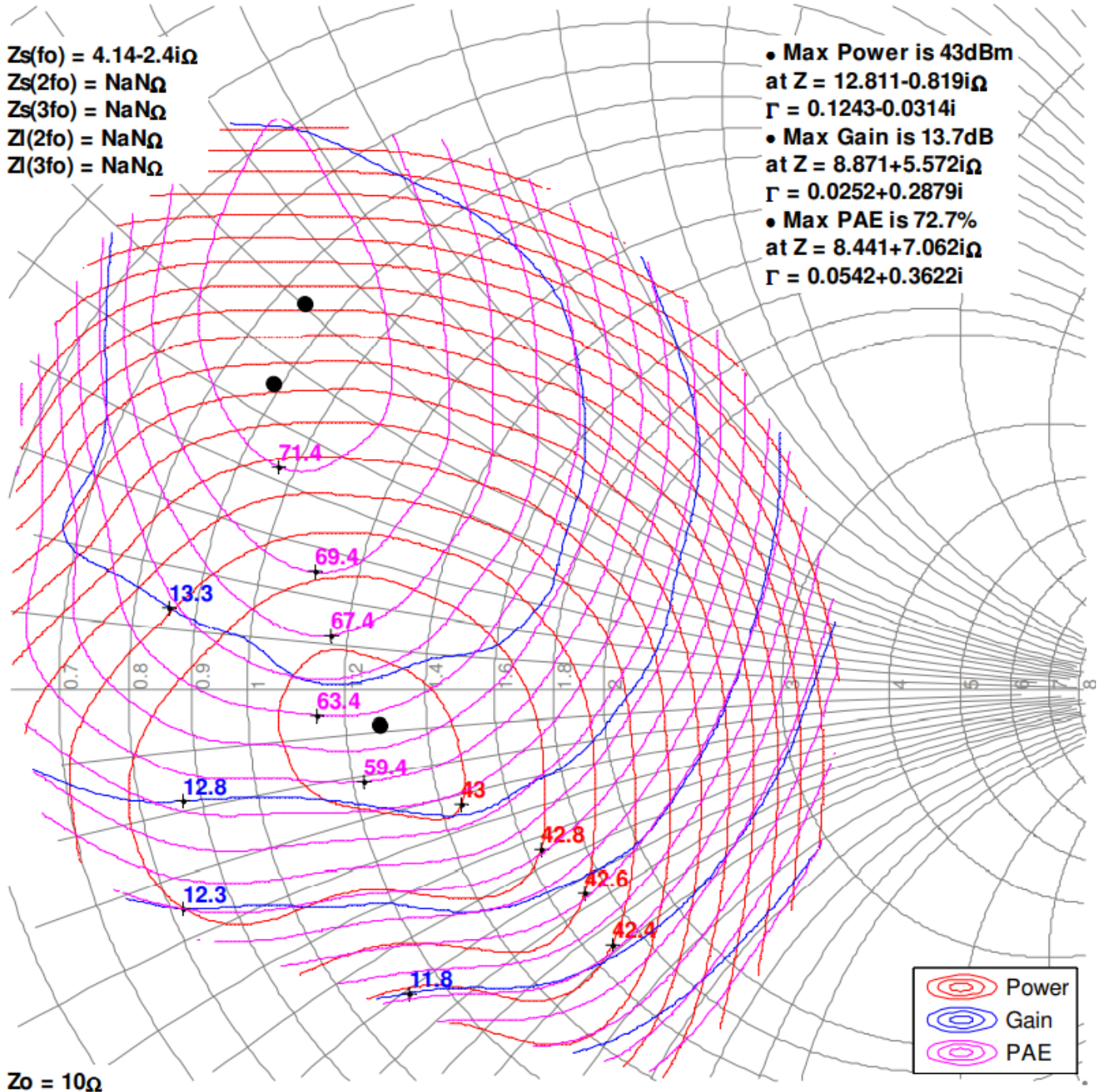

Load Pull Contours^(1,2,3,4,5)

Notes:

1. The impedances shown are those presented to the device at load pull reference planes. See page 13.
2. Test Conditions: $V_{DS} = 28\text{ V}$, $I_{DQ} = 50\text{ mA}$
3. Test Signal: Pulse Width = 100 μsec , Duty Cycle = 20%
4. NaN indicates the value was not set during load pull.
5. Z_0 is the characteristic impedance of load pull fixtures.

4GHz, Load-pull

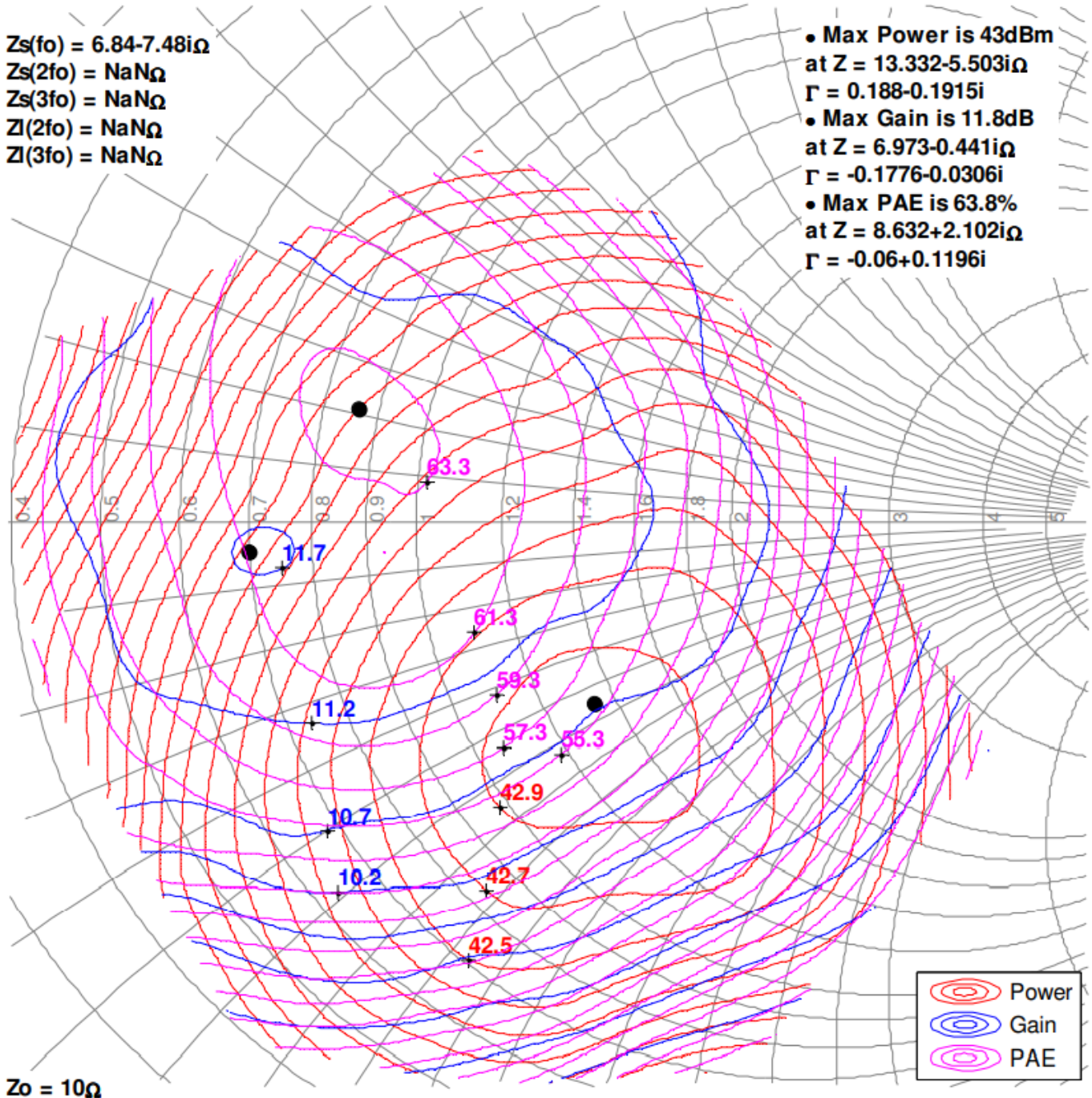

Load Pull Contours^(1,2,3,4,5)

Notes:

1. The impedances shown are those presented to the device at load pull reference planes. See page 13.
2. Test Conditions: $V_{DS} = 28\text{ V}$, $I_{DQ} = 50\text{ mA}$
3. Test Signal: Pulse Width = 100 μsec , Duty Cycle = 20%
4. NaN indicates the value was not set during load pull.
5. Z_0 is the characteristic impedance of load pull fixtures.

5GHz, Load-pull

$Z_s(f_0) = 6.83-11.52i\Omega$
 $Z_s(2f_0) = \text{NaN}\Omega$
 $Z_s(3f_0) = \text{NaN}\Omega$
 $Z_l(2f_0) = \text{NaN}\Omega$
 $Z_l(3f_0) = \text{NaN}\Omega$

- Max Power is 43.6dBm at $Z = 18.018-14.582i\Omega$
 $\Gamma = 0.4383-0.2923i$
- Max Gain is 11.4dB at $Z = 6.166-3.677i\Omega$
 $\Gamma = -0.1763-0.2675i$
- Max PAE is 66.4% at $Z = 8.088-10.399i\Omega$
 $\Gamma = 0.169-0.4778i$

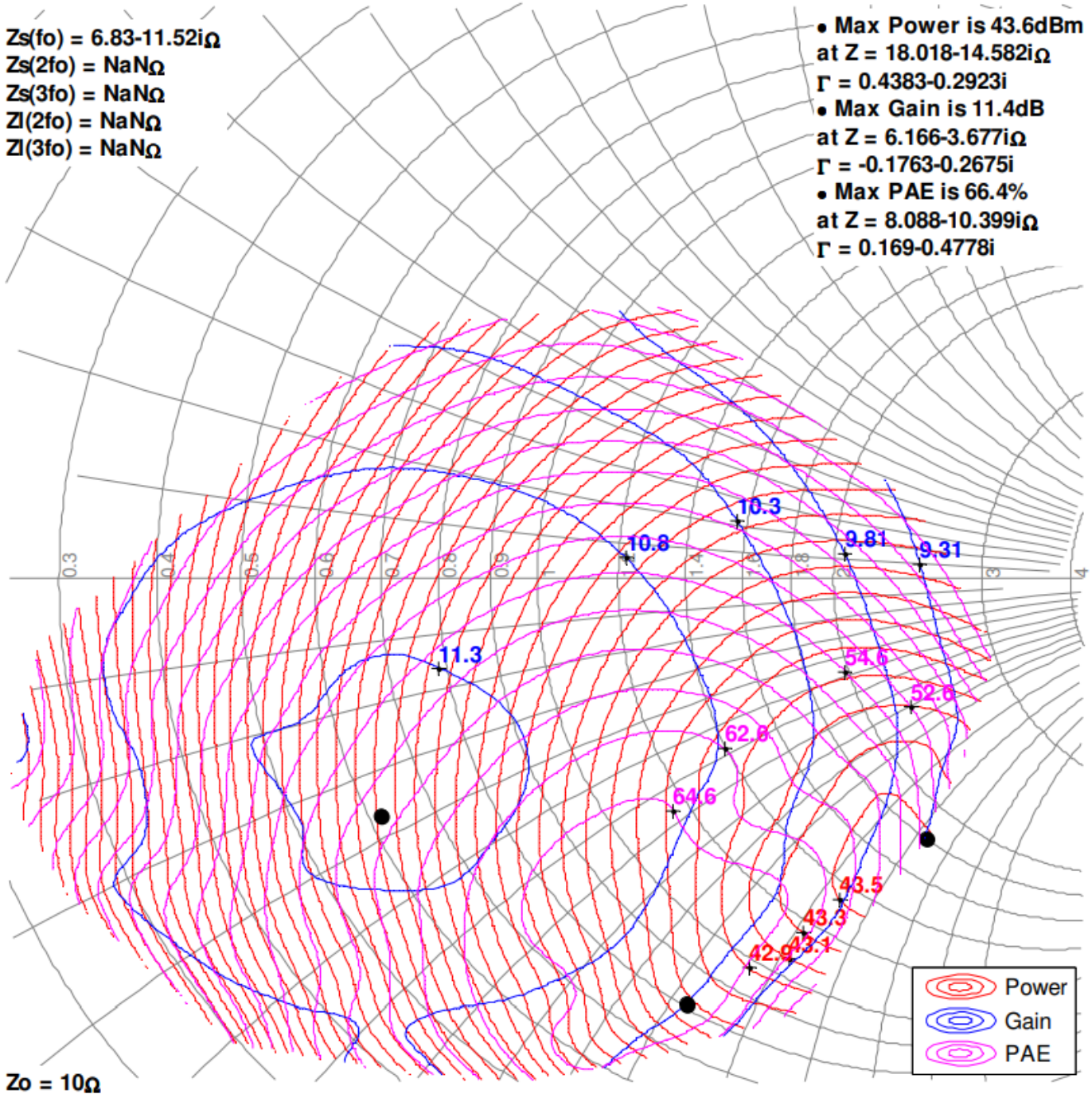

Load Pull Contours^(1,2,3,4,5)

Notes:

1. The impedances shown are those presented to the device at load pull reference planes. See page 13.
2. Test Conditions: $V_{DS} = 28\text{ V}$, $I_{DQ} = 50\text{ mA}$
3. Test Signal: Pulse Width = 100 μsec , Duty Cycle = 20%
4. NaN indicates the value was not set during load pull.
5. Z_0 is the characteristic impedance of load pull fixtures.

6GHz, Load-pull

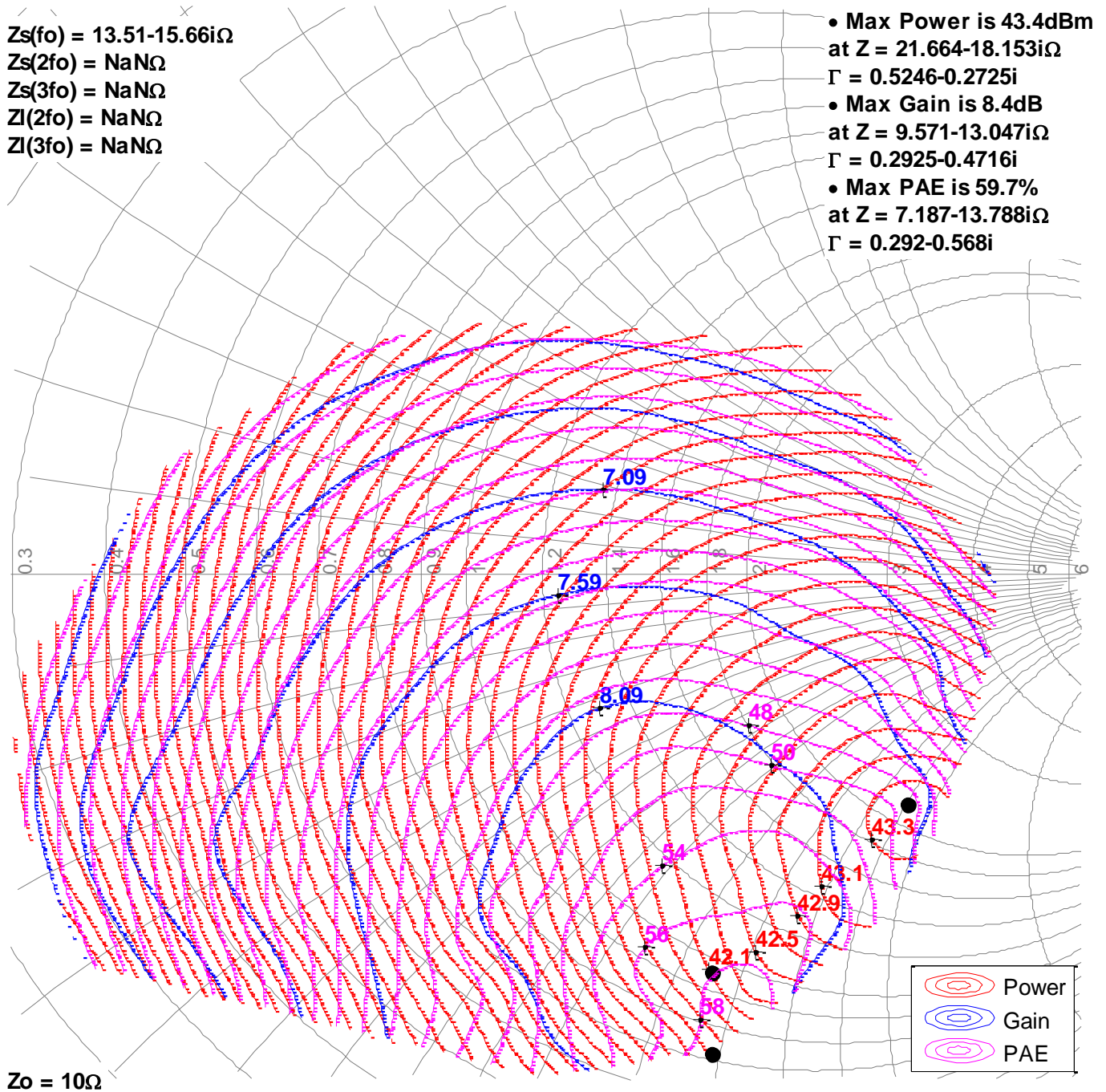

Typical Performance

Performance is based on compromised impedance point and measured at DUT reference planes. See page 13.

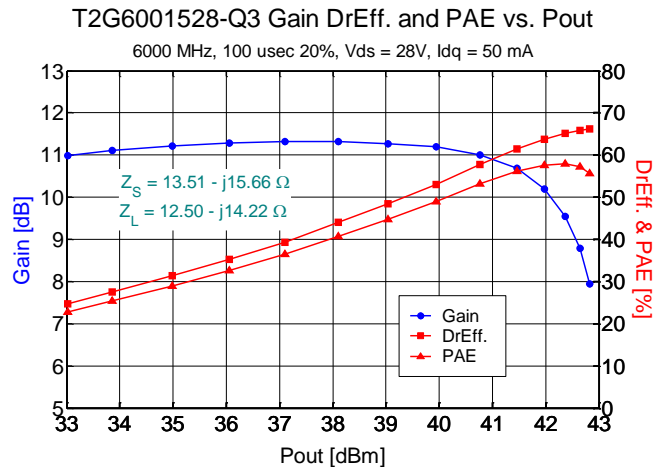
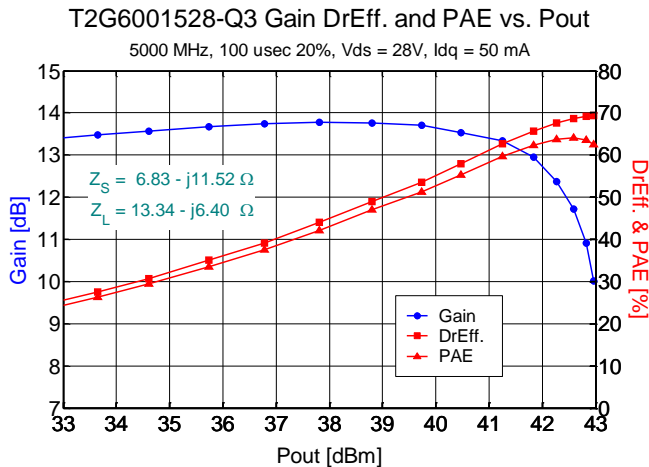
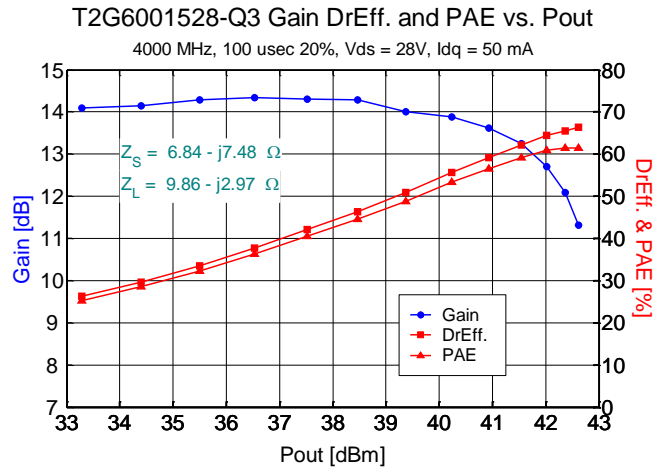
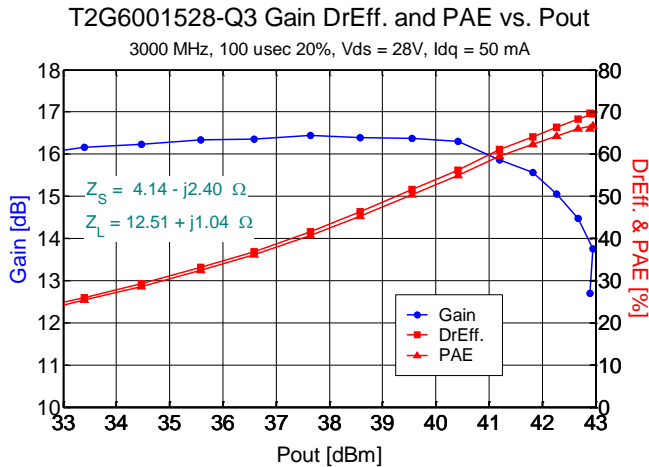
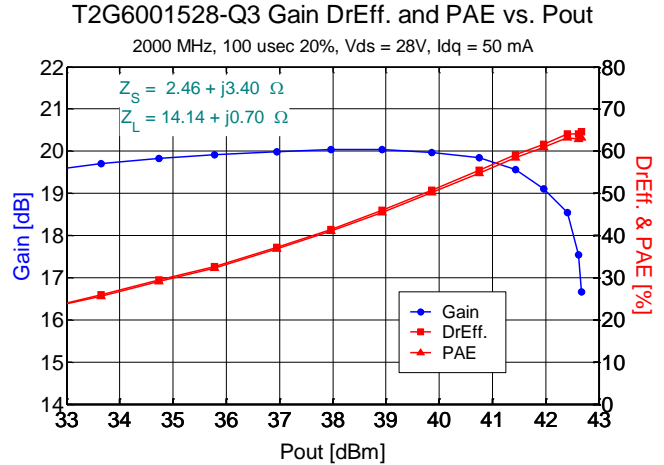
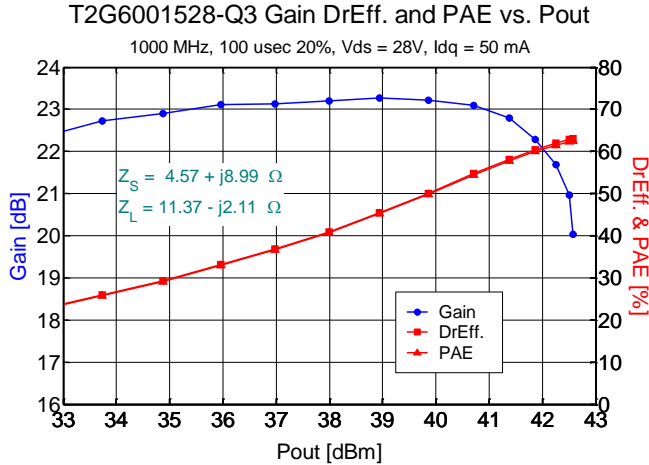

Performance Over Temperature^(1,2)

Performance measured in Qorvo's 5.0 GHz to 6.0 GHz Evaluation Board at 3dB Compression.

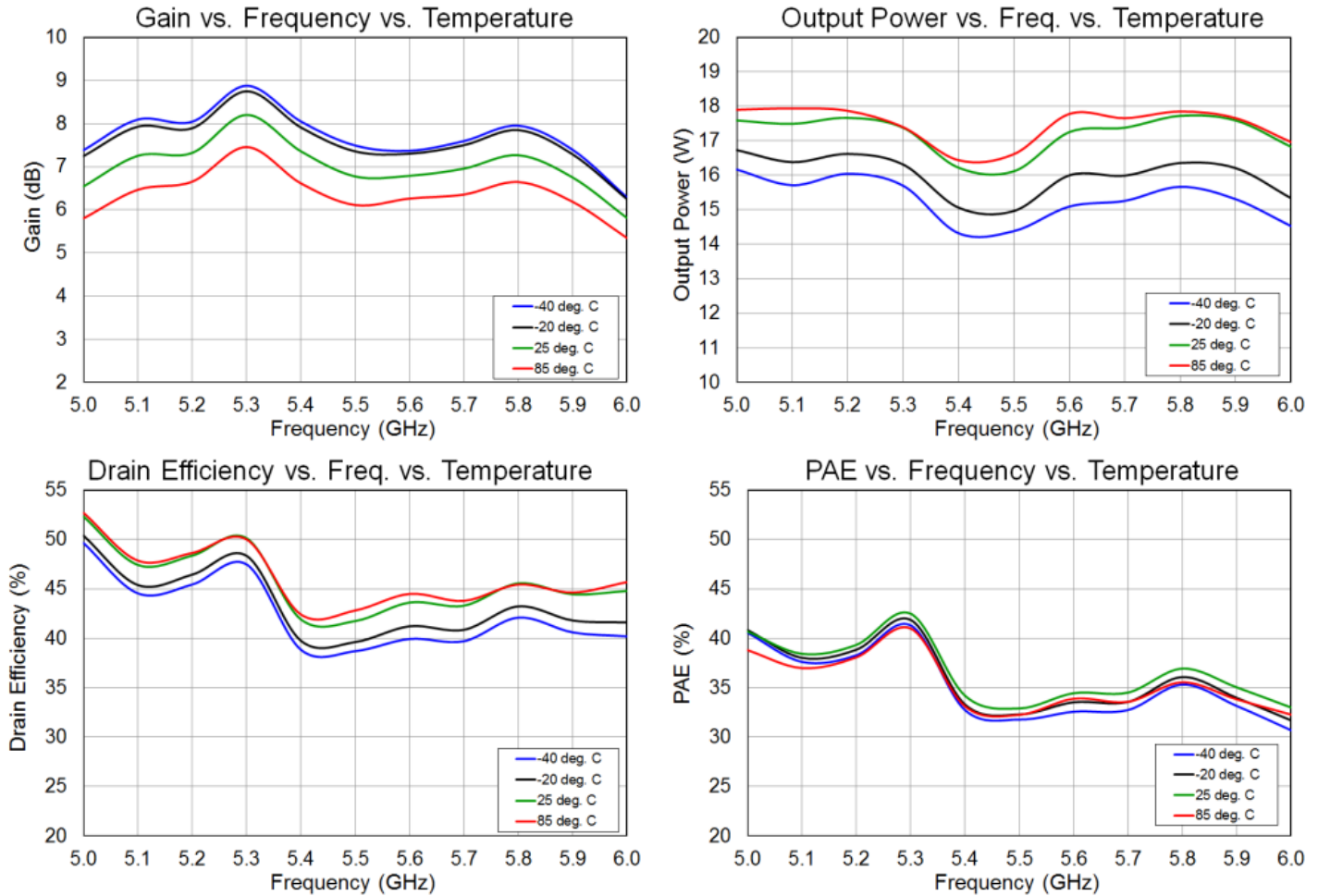

Note:

1. Test Conditions: $V_{DS} = 28 \text{ V}$, $I_{DQ} = 50 \text{ mA}$
2. Test Signal: Pulse Width = $100 \mu\text{s}$, Duty Cycle = 20%

T2G6001528-Q3-EVB1 Performance Plots – 5.0 – 6.0 GHz Reference Design^(1,2)

Performance at 3 dB Compression

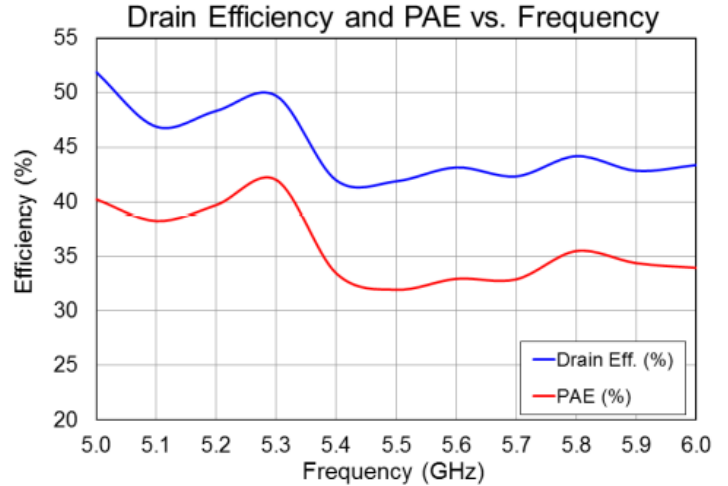
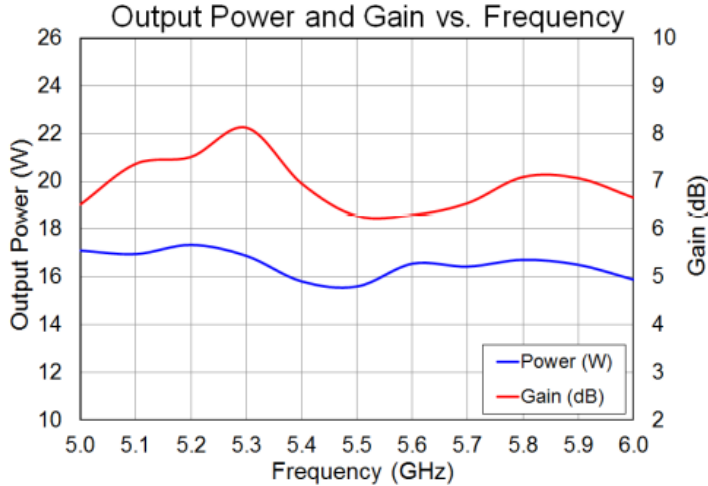

Notes:

1. Test Conditions: $V_{DS} = 28\text{ V}$, $I_{DQ} = 50\text{ mA}$
2. Test Signal: Pulse Width = $100\text{ }\mu\text{s}$, Duty Cycle = 20%

Application Circuit

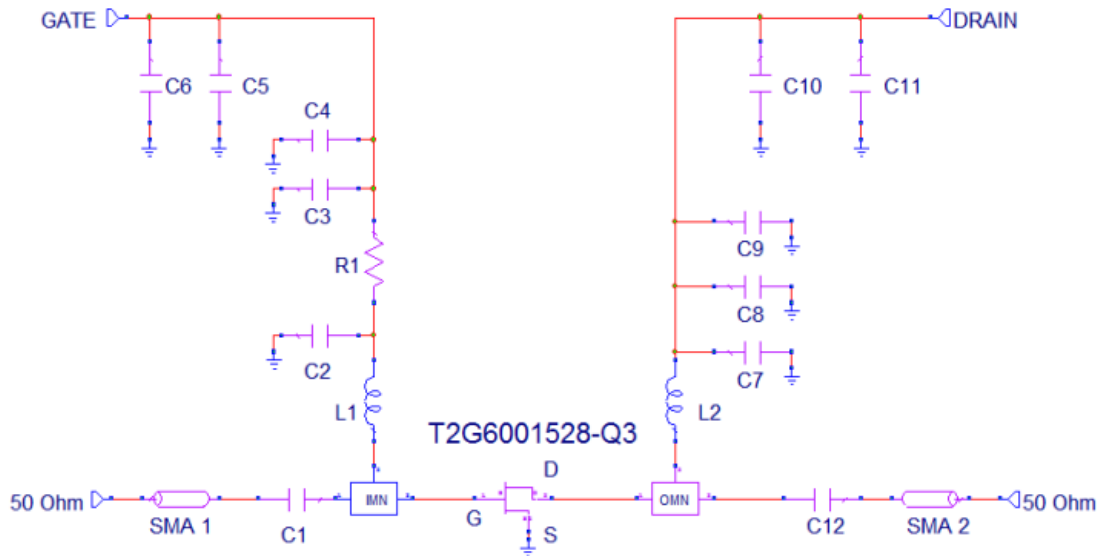

Biassing Procedure

Bias On

1. Turn ON V_G to -5 V .
2. Turn ON V_D to $+28\text{ V}$.
3. Slowly adjust V_G until $I_D = 50\text{ mA}$.
4. Turn ON RF.

Bias Off

1. Turn OFF RF.
2. Adjust V_G to -5 V .
3. Turn OFF V_D .
4. Wait two (2) seconds to allow drain capacitors to discharge.
5. Turn OFF V_G .

T2G6001528-Q3EVB1 Layout – 5.0 – 6.0 GHz Reference Design

Top RF Layer is 0.020" thick Rogers RO3203, $\epsilon_r = 3.02$. The pad pattern shown has been developed and tested for optimized assembly at Qorvo Semiconductor. The PCB land pattern has been developed to accommodate lead and package tolerances.

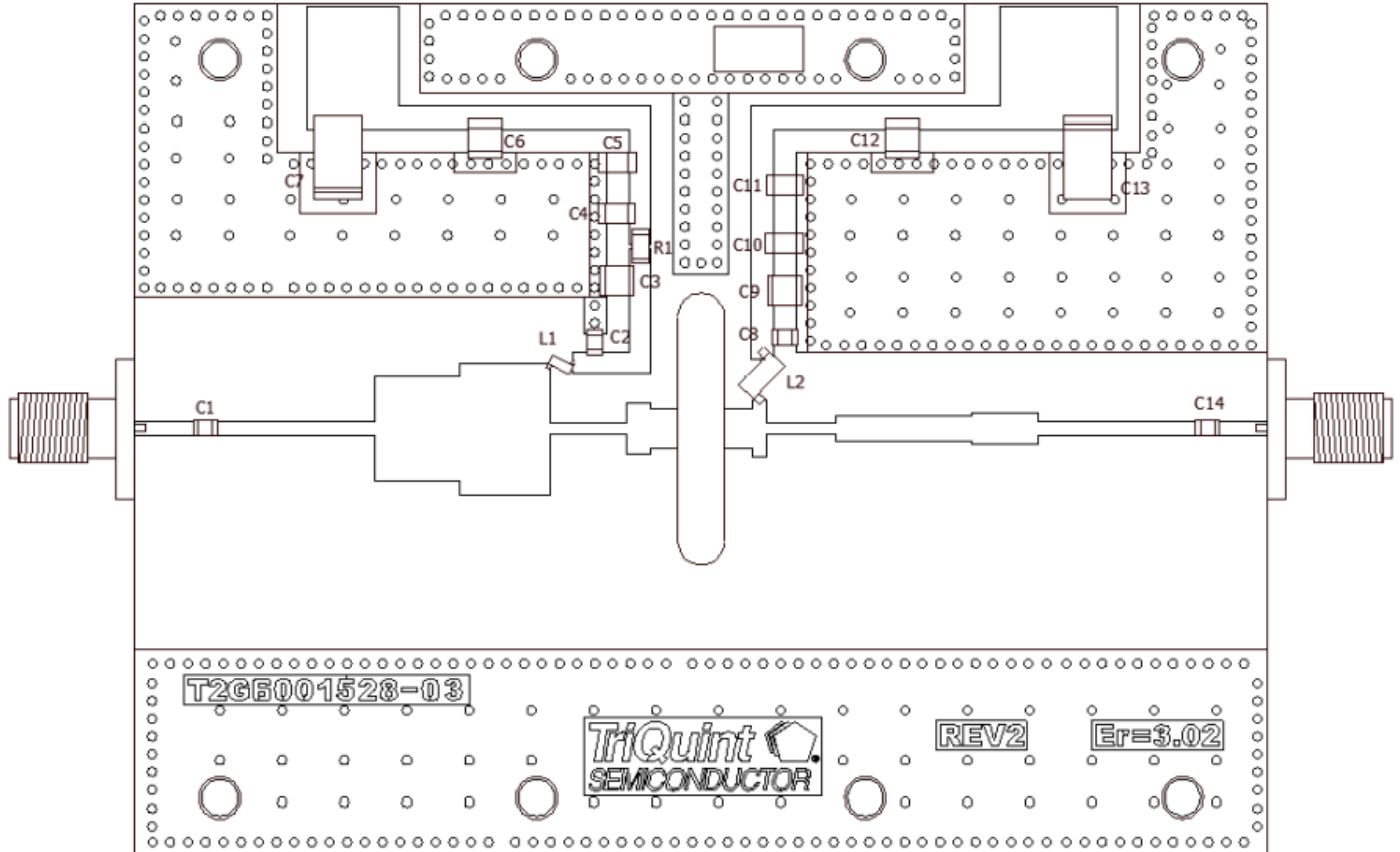

T2G6001528-Q3EVB1 Bill of Materials – 5.0 – 6.0 GHz Reference Design

Reference Des.	Value	Description	Manuf.	Part Number
C1, C14	100 pF	-	ATC	100A101JW500XC
C2, C8	2400 pF	-	Dielectric Labs	C08BL242X-5UN-XOB
C3, C9	100 pF	-	ATC	100B101GT500X
C4, C10	0.01 μ F	-	Kemet	C1206C103K1RACTU
C5, C11	0.1 μ F	-	Kemet	C1206C104K1RACTU
C6, C12	1.0 μ F	-	AVX	1812C105KAT2A
C7, C13	22 μ F	-	Sprague	226K035AT
L1	5.4 nH	-	Coilcraft	0906-5JL
L2	9.85 nH	-	Coilcraft	1606-9JLB
R1	12.1 Ω	-	Vishay	CRC120612R1FKEA

Pin Configuration and Description⁽¹⁾

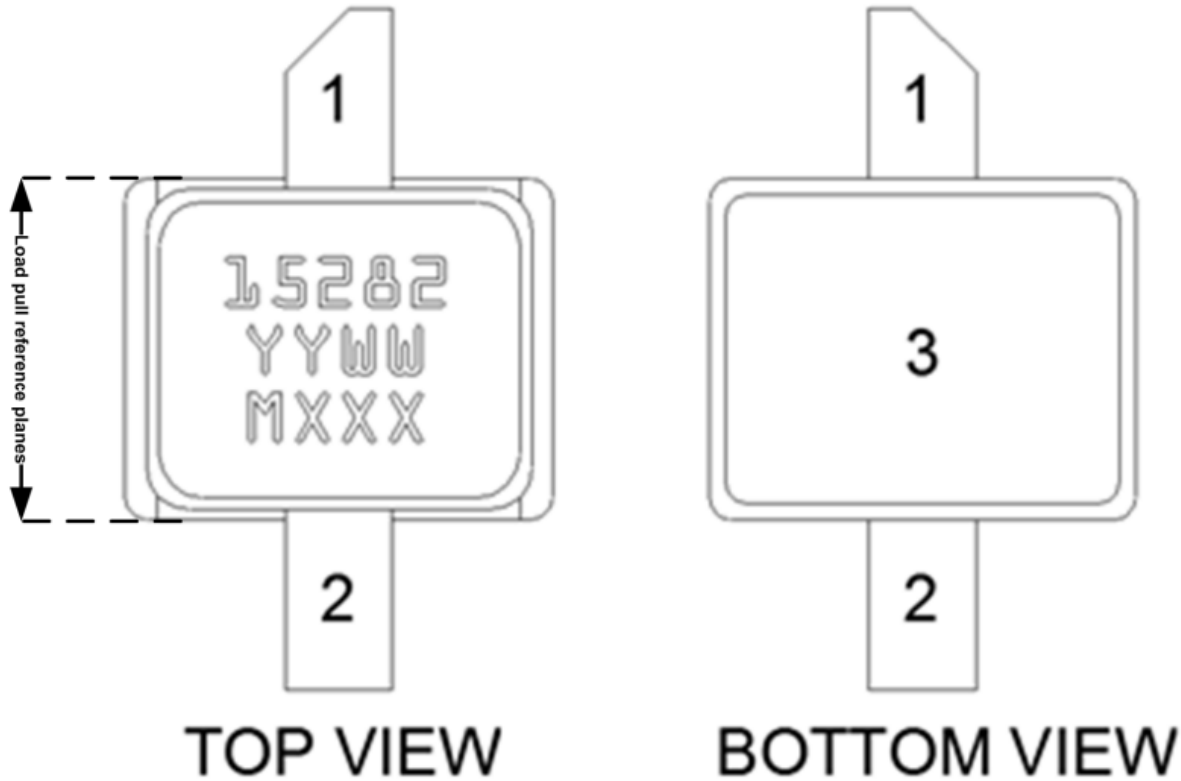

Pin Number	Label	Description
1	V_D / RF_{OUT}	Drain voltage / RF Output matched to 50 Ω ; see EVB Layout on page 10 as an example.
2	V_G / RF_{IN}	Gate voltage / RF Input matched to 50 Ω ; see EVB Layout on page 10 as an example.
3	Flange	Source connected to ground; see EVB Layout on page 10 as an example.

- Note:
- The T2G6001528-Q3 will be marked with the “15282” designator and a lot code marked below the part designator. The “YY” represents the last two digits of the calendar year the part was manufactured, the “WW” is the work week of the assembly lot start, and the “MXXX” is the production lot number.

Package Marking and Dimensions⁽¹⁾

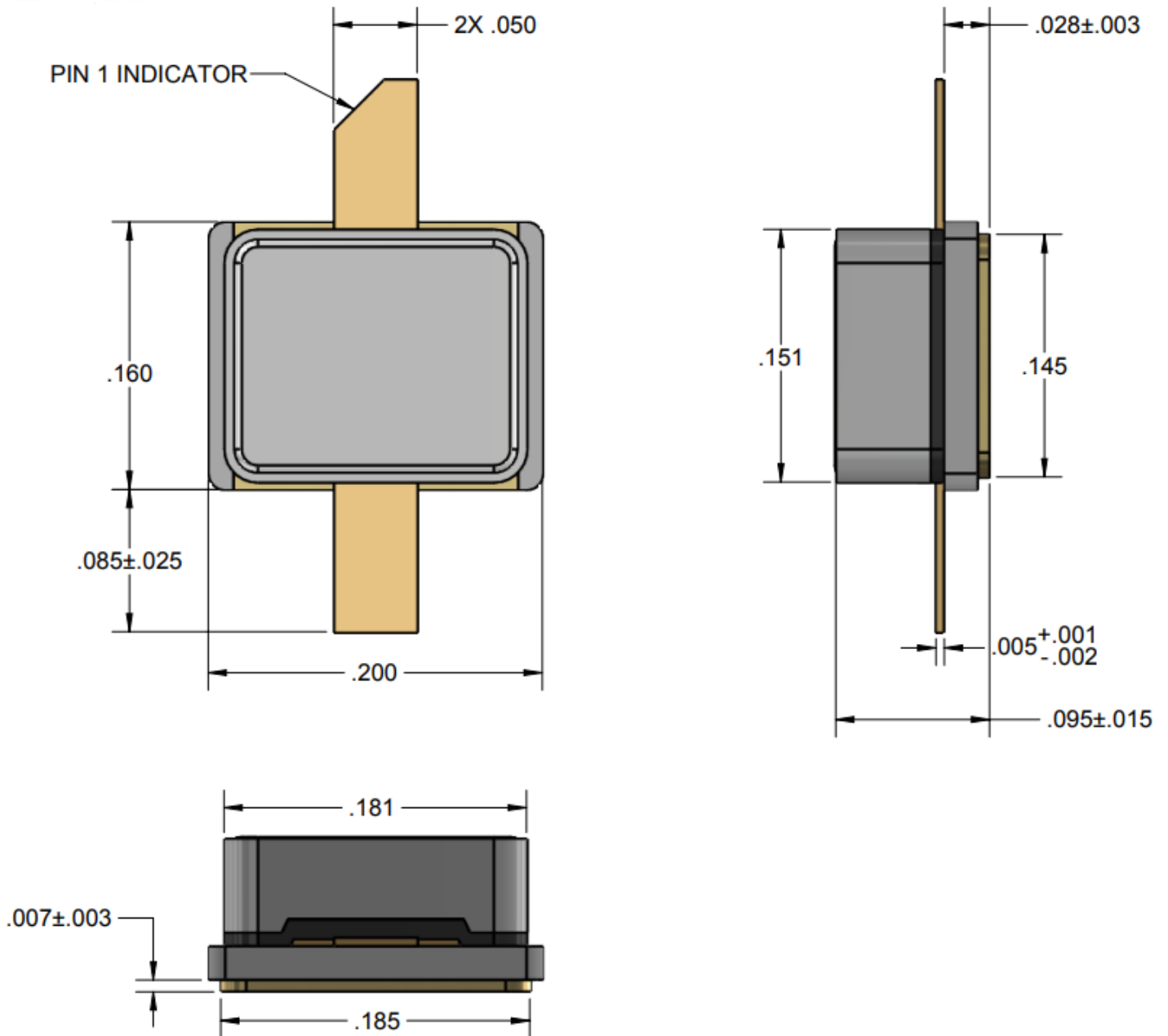

Notes:

1. Unless otherwise noted, tolerance is $.XXX \pm .005$ ".
2. Material:
 - Package Base: Ceramic/Metal
 - Package Lid: Ceramic
3. Package exposed metallization is gold plated.
4. Part is epoxy sealed.
5. Parts meet industry NI-200 footprint
6. Body dimensions do not include lid shift or epoxy run out which can be up to 20 mils per side.

Recommended Solder Temperature Profile

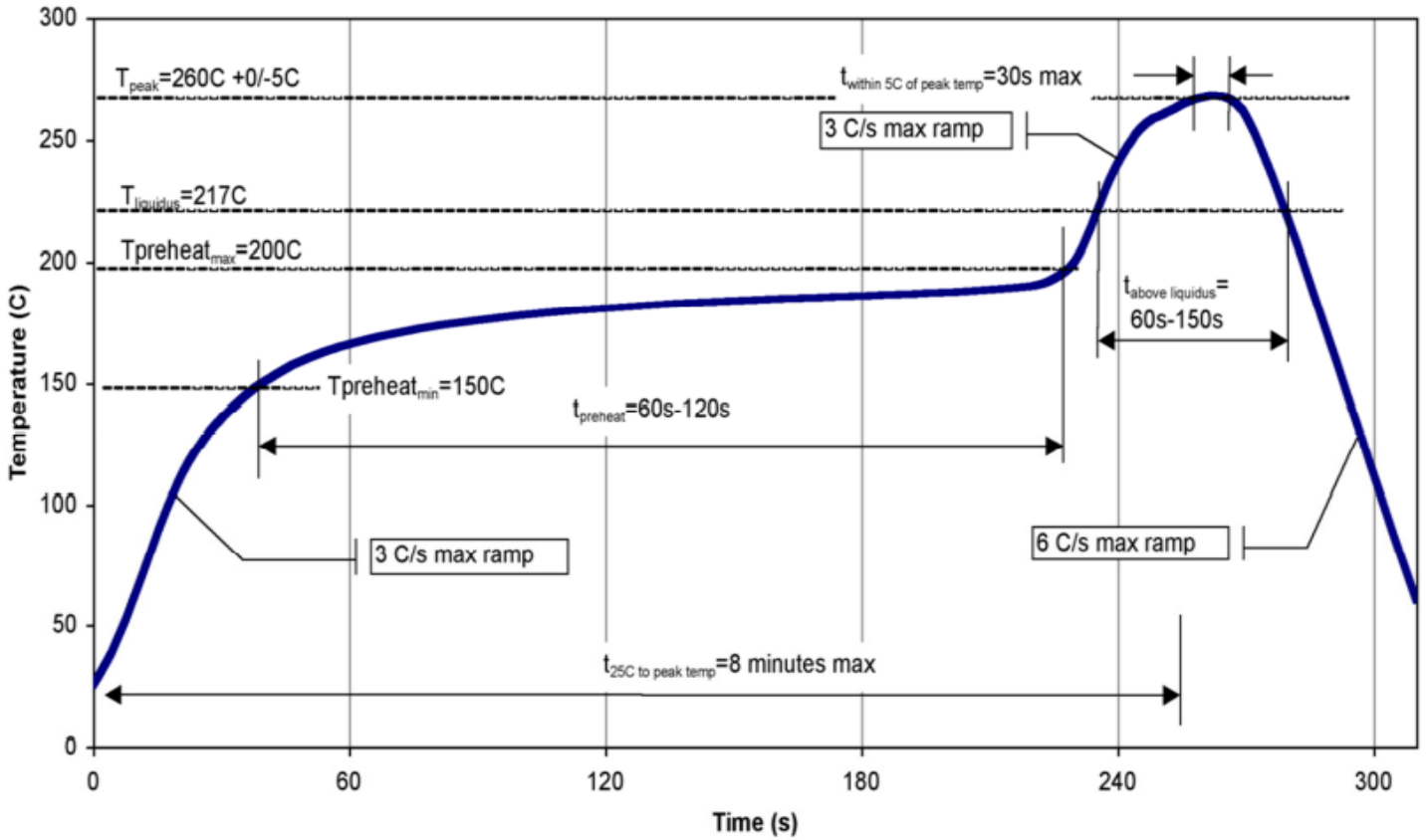

Handling Precautions

Parameter	Rating	Standard
ESD – Human Body Model (HBM)	Class 1A (250 V)	Per EIA/JESD22-A114 Standard
ESD – Charged Device Model (CDM)	Class C3 (1000V)	Per EIA/JESD22-C101 Standard
MSL – Moisture Sensitivity Level	Level 3	IPC/JEDEC Standard J-STD-020



Caution!

ESD-Sensitive
Device

Solderability

Compatible with the latest version of J-STD-020, Lead free solder, 260 °C.

RoHS Compliance

This part is compliant with 2011/65/EU RoHS directive (Restrictions on the Use of Certain Hazardous Substances in Electrical and Electronic Equipment) as amended by Directive 2015/863/EU.

This product also has the following attributes:

- Lead Free
- Halogen Free (Chlorine, Bromine)
- Antimony Free
- TBBP-A (C₁₅H₁₂Br₄O₂) Free
- PFOS Free
- SVHC Free

Contact Information

For the latest specifications, additional product information, worldwide sales and distribution locations:

Web: www.qorvo.com

Tel: 1-844-890-8163

Email: customer.support@qorvo.com

Important Notice

The information contained herein is believed to be reliable; however, Qorvo makes no warranties regarding the information contained herein and assumes no responsibility or liability whatsoever for the use of the information contained herein. All information contained herein is subject to change without notice. Customers should obtain and verify the latest relevant information before placing orders for Qorvo products. The information contained herein or any use of such information does not grant, explicitly or implicitly, to any party any patent rights, licenses, or any other intellectual property rights, whether with regard to such information itself or anything described by such information. **THIS INFORMATION DOES NOT CONSTITUTE A WARRANTY WITH RESPECT TO THE PRODUCTS DESCRIBED HEREIN, AND QORVO HEREBY DISCLAIMS ANY AND ALL WARRANTIES WITH RESPECT TO SUCH PRODUCTS WHETHER EXPRESS OR IMPLIED BY LAW, COURSE OF DEALING, COURSE OF PERFORMANCE, USAGE OF TRADE OR OTHERWISE, INCLUDING THE IMPLIED WARRANTIES OF MERCHANTABILITY AND FITNESS FOR A PARTICULAR PURPOSE.**

Without limiting the generality of the foregoing, Qorvo products are not warranted or authorized for use as critical components in medical, life-saving, or life-sustaining applications, or other applications where a failure would reasonably be expected to cause severe personal injury or death.

Copyright 2021 © Qorvo, Inc. | Qorvo is a registered trademark of Qorvo, Inc.