

### Product Overview

The Qorvo T2G6003028-FL is a 30W ( $P_{3dB}$ ) discrete GaN on SiC HEMT which operates from DC to 6 GHz. The device is constructed with Qorvo’s proven QGaN25 process, which features advanced field plate techniques to optimize power and efficiency at high drain bias operating conditions. This optimization can potentially lower system costs in terms of fewer amplifier line-ups and lower thermal management costs.

Lead-free and ROHS compliant

Evaluation boards are available upon request.



### Functional Block Diagram

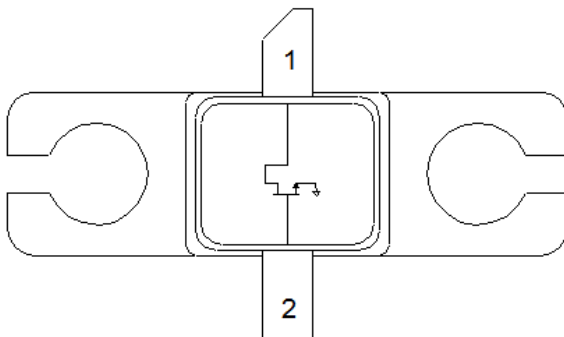

### Pin Configuration

Pin No.	Label
1	$V_D$ / RF OUT
2	$V_G$ / RF IN
Flange	Source

### Key Features <sup>1</sup>

- Frequency: DC to 6 GHz
  - Output Power ( $P_{3dB}$ ): 42.7 W
  - Linear Gain: >14 dB
  - Operating Voltage: 28 V
  - Low thermal resistance package
  - Pulse capable
- Note 1: @ 3 GHz

### Applications

- Military radar
- Civilian radar
- Professional and military radio communications
- Test instrumentation
- Wideband or narrowband amplifiers
- Jammers

### Ordering info

Part No.	Description
T2G6003028-FL	Packaged part Flanged
T2G6003028-FSEVB	5.4 – 5.9 GHz Evaluation Board
T2G6003028-FSEVB2	1.3 – 1.9 GHz Evaluation Board



# T2G6003028-FL

30 W, 28V DC – 6 GHz, GaN RF Power Transistor

## Absolute Maximum Ratings

Parameter	Rating	Units
Breakdown Voltage, $BV_{DG}$	100	V
Gate Voltage Range, $V_G$	-7 to +2	V
Drain Current, $I_{D_{MAX}}$	5.5	A
Gate Current Range, $I_G$	-10 to 28	mA
Power Dissipation, Pulsed, $P_{DISS}$	47.5	W
RF Input Power, CW, $T = 25^\circ\text{C}$ ( $P_{IN}$ )	40	dBm
Channel Temperature ( $T_{CH}$ )	275	$^\circ\text{C}$
Mounting Temperature (30 Seconds)	320	$^\circ\text{C}$
Storage Temperature	-40 to +150	$^\circ\text{C}$

Operation of this device outside the parameter ranges given above may cause permanent damage. These are stress ratings only, and functional operation of the device at these conditions is not implied.

## Recommended Operating Conditions <sup>1, 2</sup>

Parameter	Min	Typ	Max	Units
Drain Voltage Range, $V_D$	12		40	V
Drain Bias Current, $I_{DQ}$		200		mA
Gate Voltage, $V_G$	-	-3.0	-	V

## Electrical Specifications <sup>1, 2</sup>

Parameter	Min	Typ	Max	Units
Linear Gain, $G_{LIN}$	12	14	-	dB
Output Power at 3dB compression point, $P_{3dB}$	43.0	44.6	-	W
Drain Efficiency at 3dB compression point, $DEFF_{3dB}$	45.0	54.0	-	%
Gain at 3dB compression point, $G_{3dB}$	9.0	11.0	-	dB
Gate Leakage ( $V_D = +10\text{ V}$ , $V_G = -3.7\text{ V}$ )	-11	-	-	mA

Notes:

- Performance at 5.6 GHz in the 5.4 to 5.9 GHz Evaluation Board
- $V_{DS} = 28\text{ V}$ ,  $I_{DQ} = 200\text{ mA}$ ; Pulse: 100 $\mu\text{s}$ , 20%

## RF Characterization – Mismatch Ruggedness at 5.6 GHz <sup>1</sup>

Symbol	Parameter	dB Compression	Typical
VSWR	Impedance Mismatch Ruggedness	3	10:1

Notes:

- $P_{1dB}$  CW Input Power under matched condition.

### Power-Matched Load Pull Performance

Test conditions unless otherwise noted: T = 25°C.

Parameter	Typical Value						Units
	1	2	3	4	5	6	
Frequency (F)							GHz
Drain Voltage (V <sub>D</sub> )	28	28	28	28	28	28	V
Bias Current (I <sub>DQ</sub> )	200	200	200	200	200	200	mA
Output P <sub>3dB</sub> (P <sub>3dB</sub> )	45.7	46	46.3	46.5	46.8	46.2	dBm
PAE @ P <sub>3dB</sub> (PAE <sub>3dB</sub> )	64.9	64.2	68.1	54.6	55.9	54.7	%
Gain @ P <sub>3dB</sub> (G <sub>3dB</sub> )	19.9	15.7	11.3	10.1	10.7	12.1	dB

Notes:

- V<sub>D</sub> = 28 V, I<sub>DQ</sub> = 200 mA, Pulse Width = 100 uS, Duty Cycle = 20%
- Characteristic Impedance (Z<sub>o</sub>) = 10 Ω. See pg. 14 for Load Pull Reference Planes.

### Efficiency-Matched Load Pull Performance

Test conditions unless otherwise noted: T = 25°C.

Parameter	Typical Value						Units
	1	2	3	4	5	6	
Frequency (F)							GHz
Drain Voltage (V <sub>D</sub> )	28	28	28	28	28	28	V
Bias Current (I <sub>DQ</sub> )	200	200	200	200	200	200	mA
Output P <sub>3dB</sub> (P <sub>3dB</sub> )	43.1	43.1	44.6	44.1	44.9	45.7	dBm
PAE @ P <sub>3dB</sub> (PAE <sub>3dB</sub> )	73	76	46.1	65.1	69.5	60	%
Gain @ P <sub>3dB</sub> (G <sub>3dB</sub> )	19.7	16.2	11.7	10.8	12.4	12.9	dB

Notes:

- V<sub>D</sub> = 28 V, I<sub>DQ</sub> = 200 mA, Pulse Width = 100 uS, Duty Cycle = 20%.
- Characteristic Impedance (Z<sub>o</sub>) = 10 Ω. See pg. 14 for Load Pull Reference Planes.

### Thermal Information – CW <sup>1,2</sup>

Parameter	Test Conditions	Value	Units
Thermal Resistance, $IR^2$ ( $\theta_{JC}$ )	$P_D = 30\text{ W}$ , $T_{base} = 85^\circ\text{C}$	2.51	$^\circ\text{C/W}$
Maximum Channel Temperature, $T_{CH}$		160.25	$^\circ\text{C}$
Thermal Resistance, $IR^2$ ( $\theta_{JC}$ )	$P_D = 35\text{ W}$ , $T_{base} = 85^\circ\text{C}$	2.58	$^\circ\text{C/W}$
Maximum Channel Temperature, $T_{CH}$		175.20	$^\circ\text{C}$
Thermal Resistance, $IR^2$ ( $\theta_{JC}$ )	$P_D = 40\text{ W}$ , $T_{base} = 85^\circ\text{C}$	2.67	$^\circ\text{C/W}$
Maximum Channel Temperature, $T_{CH}$		191.68	$^\circ\text{C}$
Thermal Resistance, $IR^2$ ( $\theta_{JC}$ )	$P_D = 45\text{ W}$ , $T_{base} = 85^\circ\text{C}$	2.75	$^\circ\text{C/W}$
Maximum Channel Temperature, $T_{CH}$		208.73	$^\circ\text{C}$

Notes:

1. Thermal resistance calculated to bottom of package.
2. Refer to the following document: [GaN Device Channel Temperature, Thermal Resistance, and Reliability Estimates](#)

### Thermal Information – Pulsed <sup>1,2</sup>

Parameter	Test Conditions	Value	Units
Thermal Resistance, $IR^2$ ( $\theta_{JC}$ )	$P_D = 40\text{ W}$ , $T_{base} = 85^\circ\text{C}$ Pulse Width = 100 $\mu\text{S}$ Duty Cycle = 5%	1.56	$^\circ\text{C/W}$
Peak Channel Temperature, $T_{CH}$		147.37	$^\circ\text{C}$
Thermal Resistance, $IR^2$ ( $\theta_{JC}$ )	$P_D = 40\text{ W}$ , $T_{base} = 85^\circ\text{C}$ Pulse Width = 100 $\mu\text{S}$ Duty Cycle = 10%	1.62	$^\circ\text{C/W}$
Peak Channel Temperature, $T_{CH}$		149.83	$^\circ\text{C}$
Thermal Resistance, $IR^2$ ( $\theta_{JC}$ )	$P_D = 40\text{ W}$ , $T_{base} = 85^\circ\text{C}$ Pulse Width = 100 $\mu\text{S}$ Duty Cycle = 20%	1.77	$^\circ\text{C/W}$
Peak Channel Temperature, $T_{CH}$		155.89	$^\circ\text{C}$
Thermal Resistance, $IR^2$ ( $\theta_{JC}$ )	$P_D = 40\text{ W}$ , $T_{base} = 85^\circ\text{C}$ Pulse Width = 100 $\mu\text{S}$ Duty Cycle = 50%	2.07	$^\circ\text{C/W}$
Peak Channel Temperature, $T_{CH}$		167.69	$^\circ\text{C}$

Notes:

1. Thermal resistance calculated to bottom of package.
2. Refer to the following document: [GaN Device Channel Temperature, Thermal Resistance, and Reliability Estimates](#)

Load Pull Contours 1, 2, 3

Notes:

1. Test Conditions:  $V_{DS} = 28\text{ V}$ ,  $I_{DQ} = 200\text{ mA}$
2. Test Signal: Pulse Width = 100  $\mu\text{sec}$ , Duty Cycle = 20%
3. See pg. 14 for load pull reference planes.

1GHz, Load-pull

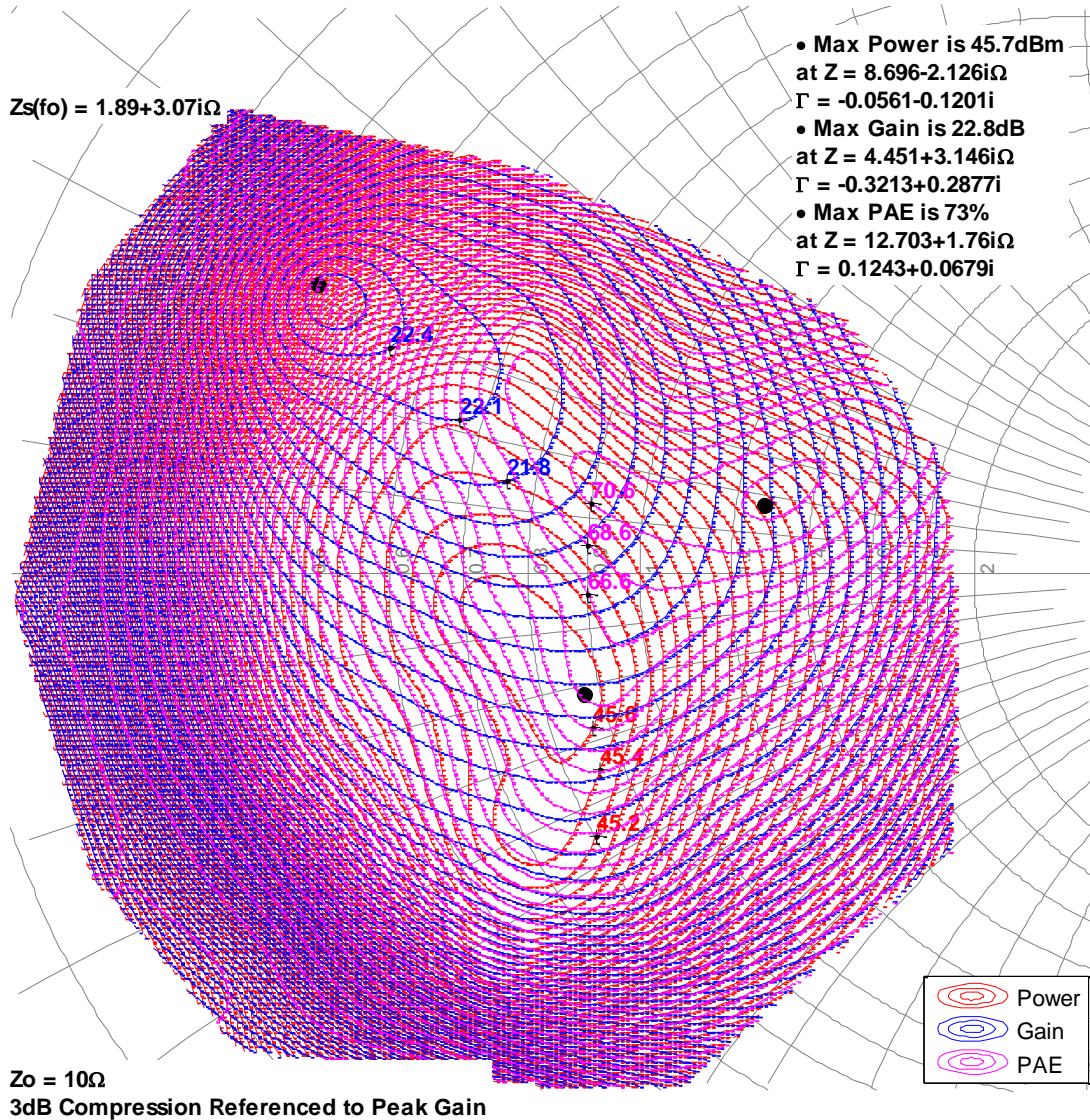

### Load Pull Contours 1, 2, 3

Notes:

1. Test Conditions:  $V_{DS} = 28\text{ V}$ ,  $I_{DQ} = 200\text{ mA}$
2. Test Signal: Pulse Width = 100  $\mu\text{sec}$ , Duty Cycle = 20%
3. See pg. 14 for load pull reference planes.

### 2GHz, Load-pull

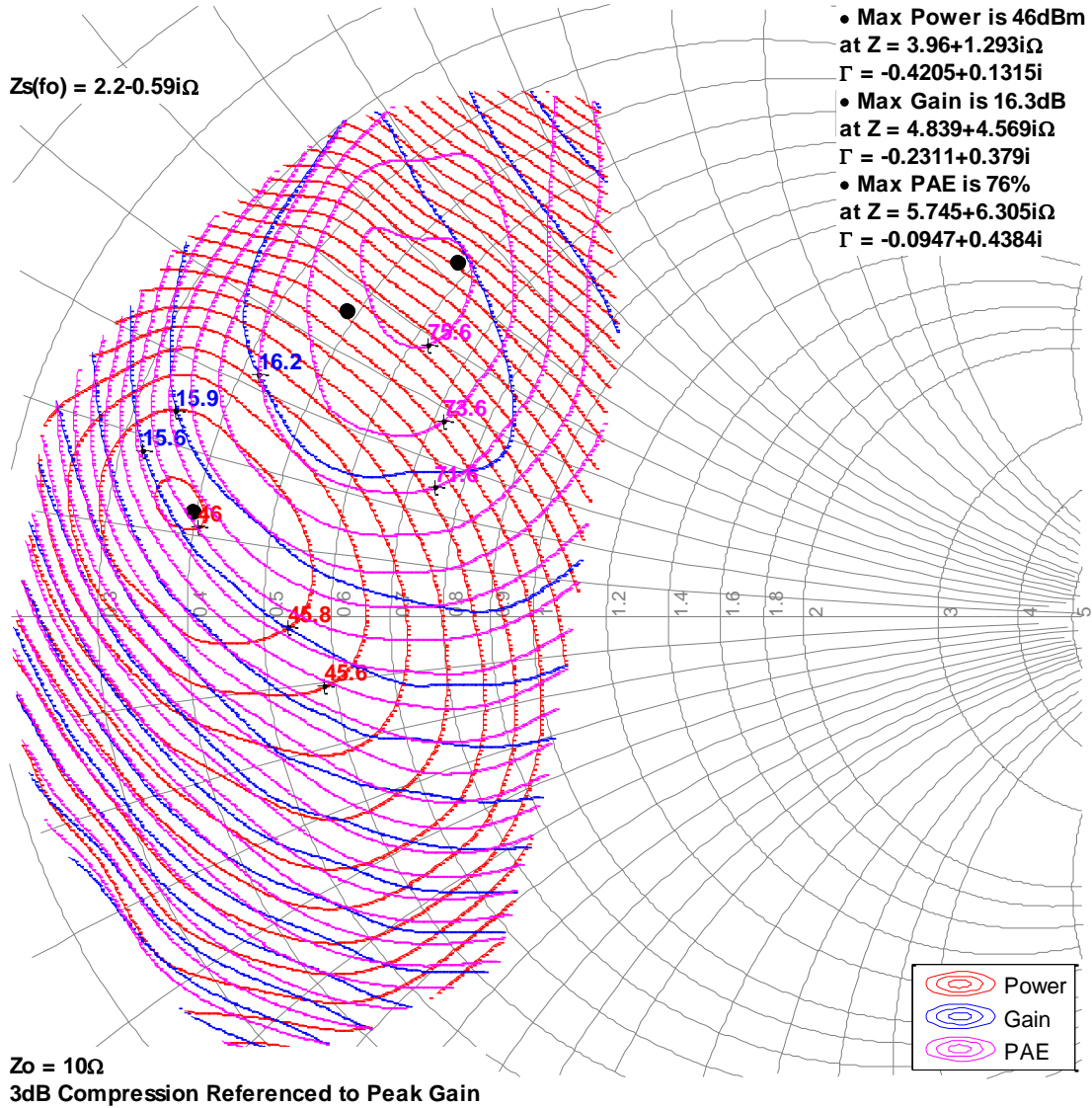

**Load Pull Contours** <sup>1, 2, 3</sup>

Notes:

1. Test Conditions:  $V_{DS} = 28\text{ V}$ ,  $I_{DQ} = 200\text{ mA}$
2. Test Signal: Pulse Width = 100  $\mu\text{sec}$ , Duty Cycle = 20%
3. See pg. 14 for load pull reference planes.

**3GHz, Load-pull**

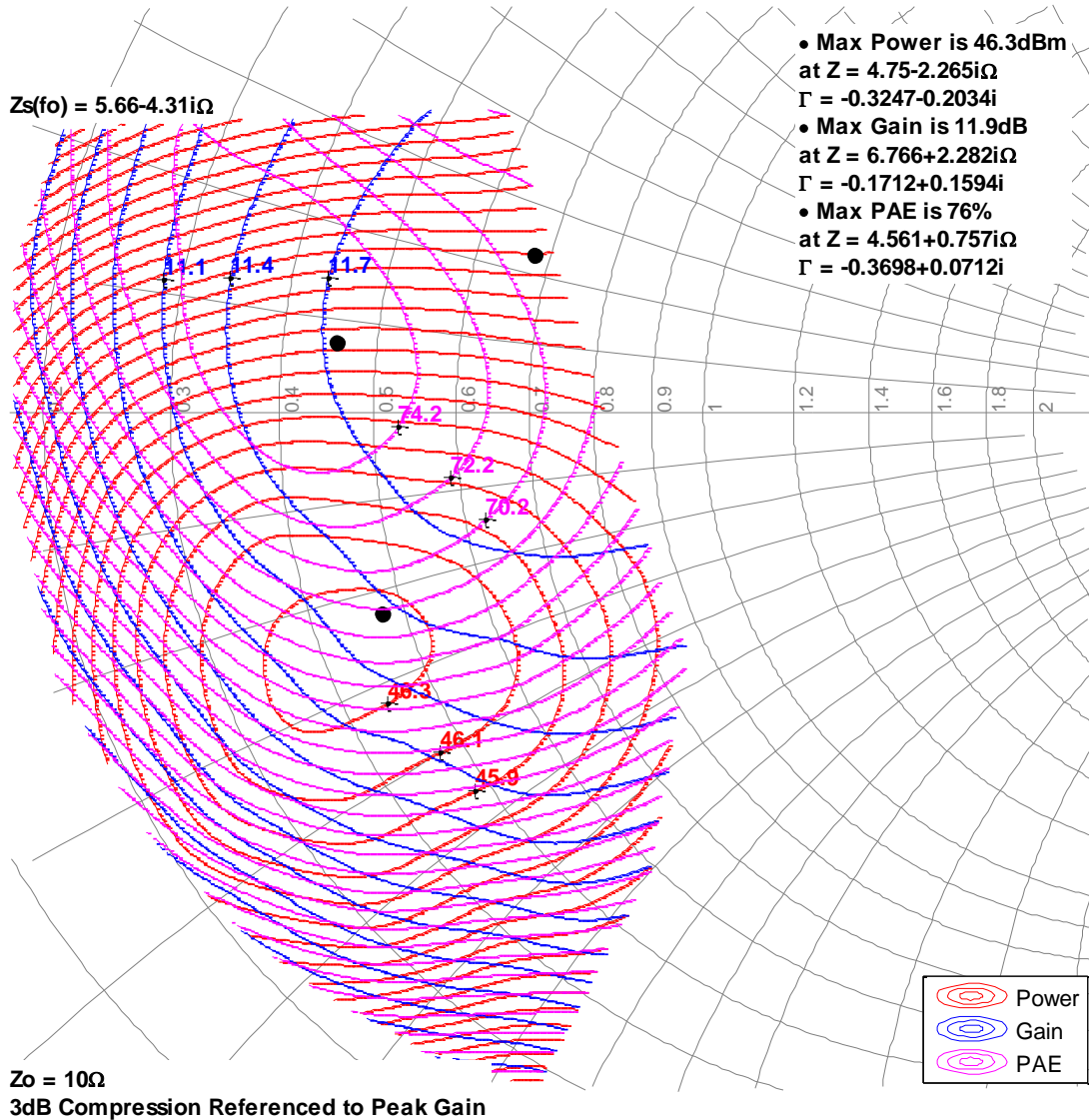

**Load Pull Contours** 1, 2, 3

Notes:

1. Test Conditions:  $V_{DS} = 28\text{ V}$ ,  $I_{DQ} = 200\text{ mA}$
2. Test Signal: Pulse Width = 100  $\mu\text{sec}$ , Duty Cycle = 20%
3. See pg. 14 for load pull reference planes.

**4GHz, Load-pull**

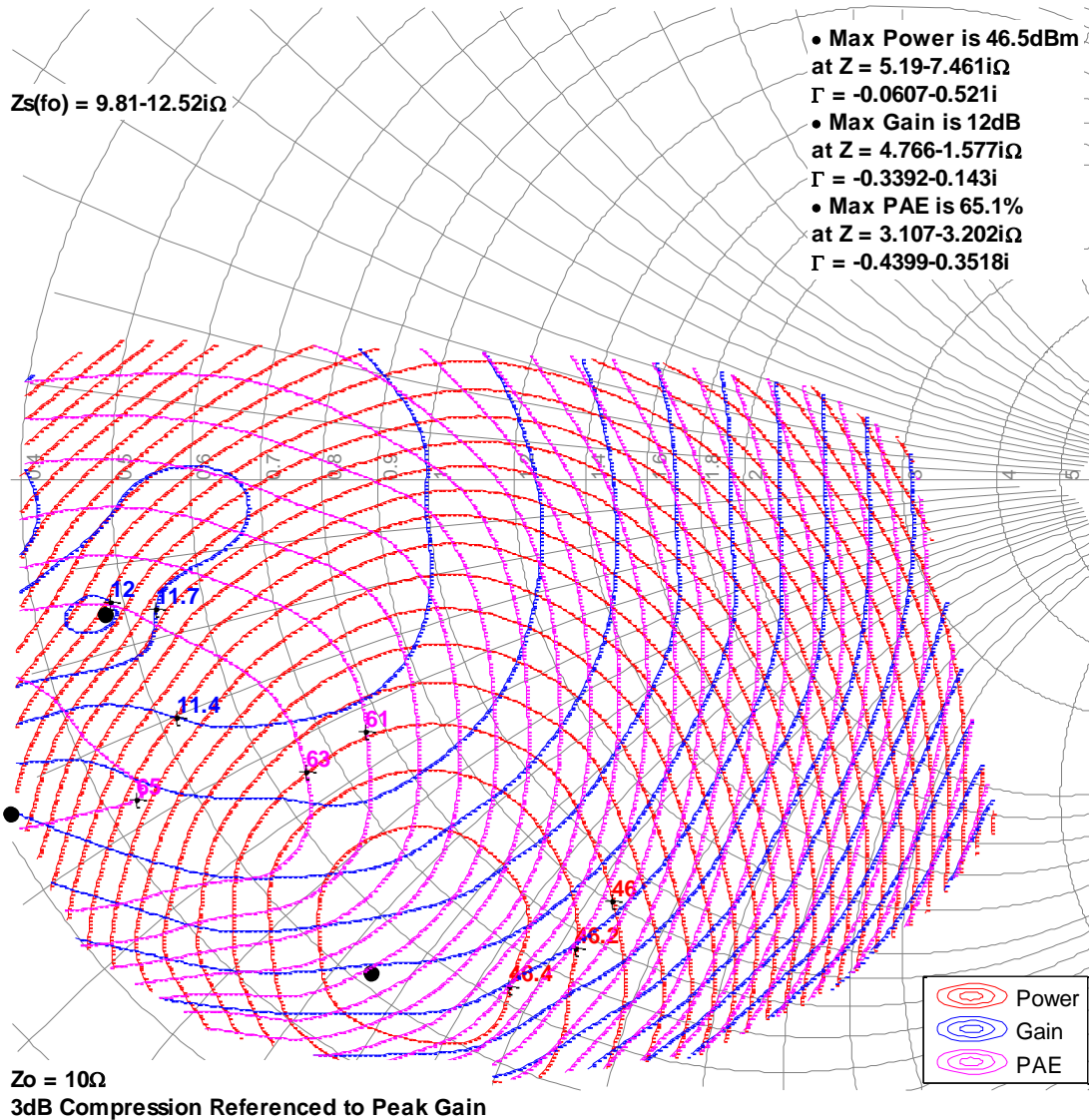



Load Pull Contours 1, 2, 3

Notes:

1. Test Conditions:  $V_{DS} = 28\text{ V}$ ,  $I_{DQ} = 200\text{ mA}$
2. Test Signal: Pulse Width = 100  $\mu\text{sec}$ , Duty Cycle = 20%
3. See pg. 14 for load pull reference planes.

5GHz, Load-pull

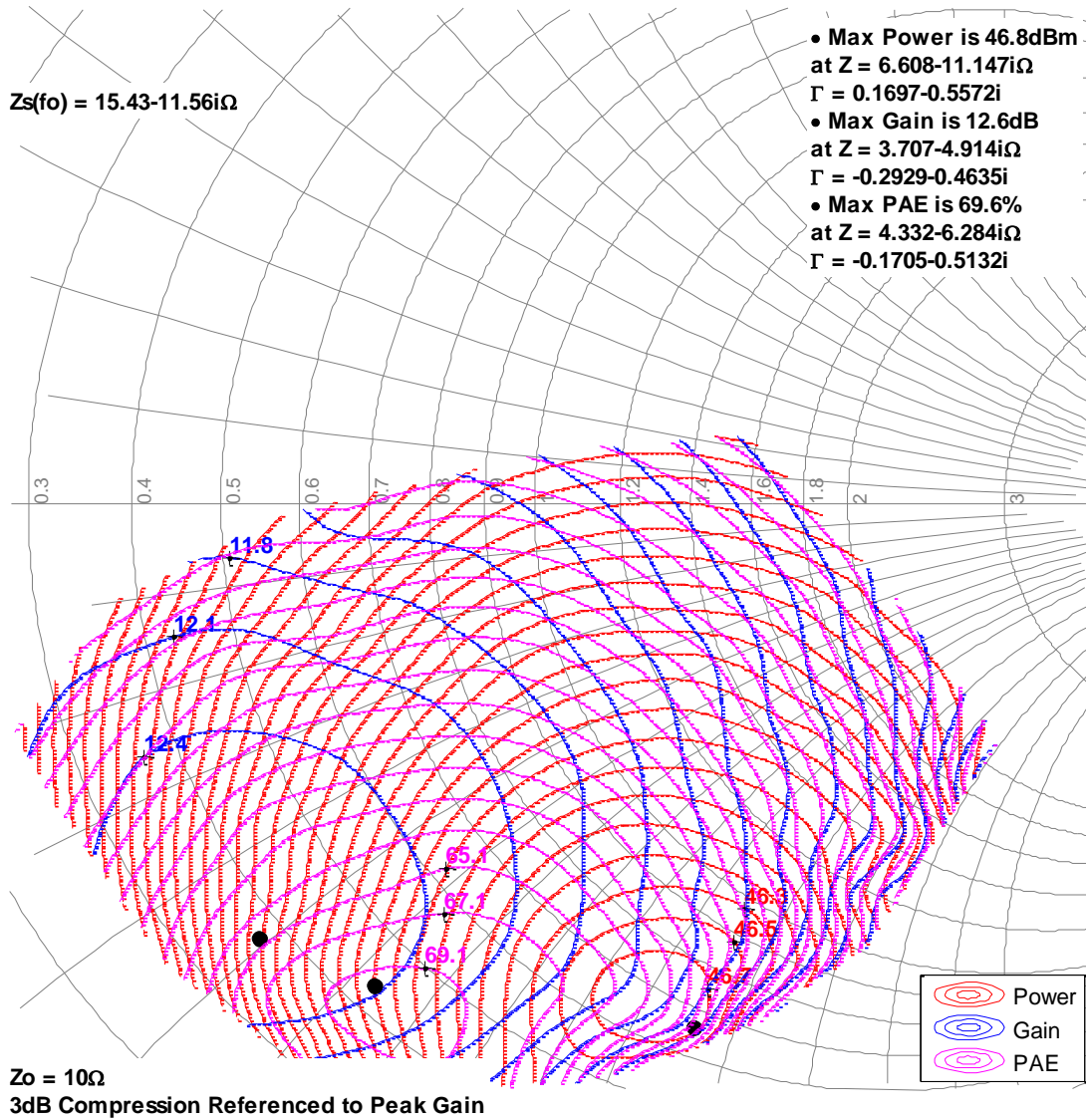

### Load Pull Contours 1, 2, 3

Notes:

1. Test Conditions:  $V_{DS} = 28\text{ V}$ ,  $I_{DQ} = 200\text{ mA}$
2. Test Signal: Pulse Width = 100  $\mu\text{sec}$ , Duty Cycle = 20%
3. See pg. 14 for load pull reference planes.

### 6GHz, Load-pull

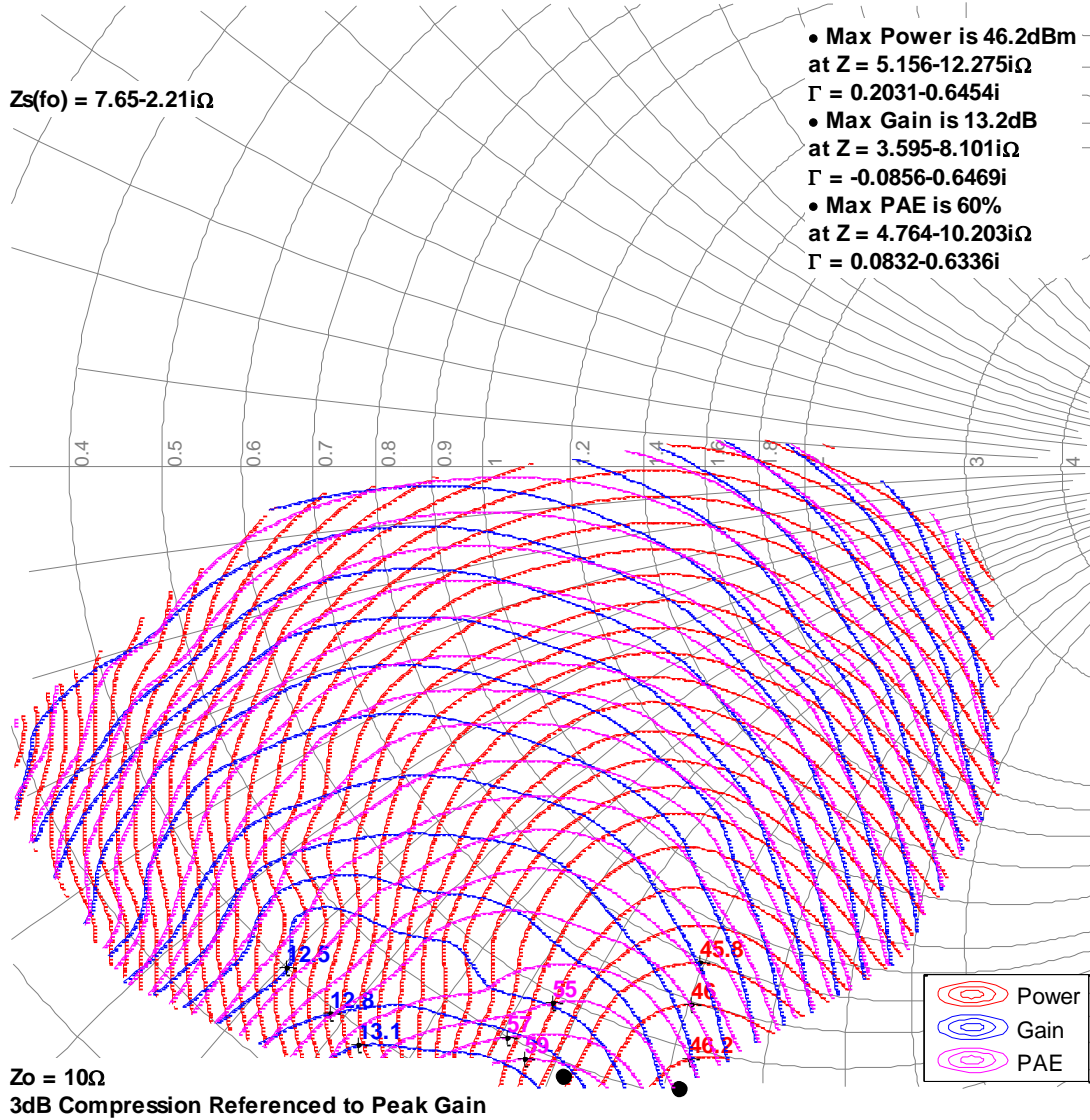

### Load Pull Drive-ups <sup>1,2</sup>

Notes:

- V<sub>d</sub> = 28 V, I<sub>dq</sub> = 200 mA, Pulse Width = 100 μs, Duty Cycle = 20%
- NaN means the parameter is either unavailable or undefined.

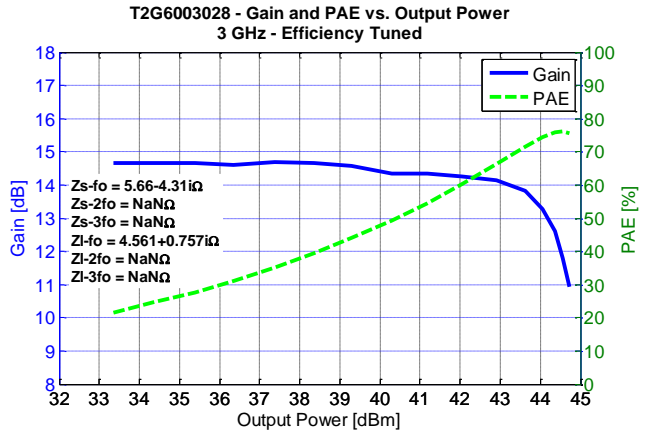
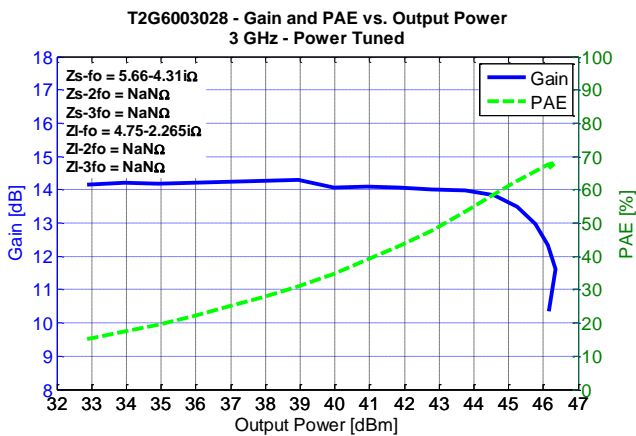
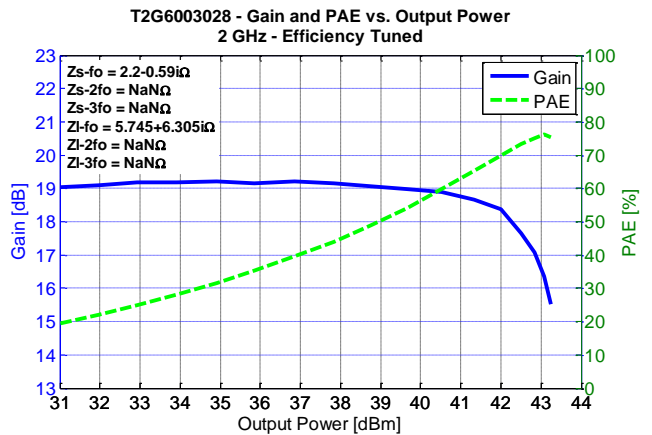
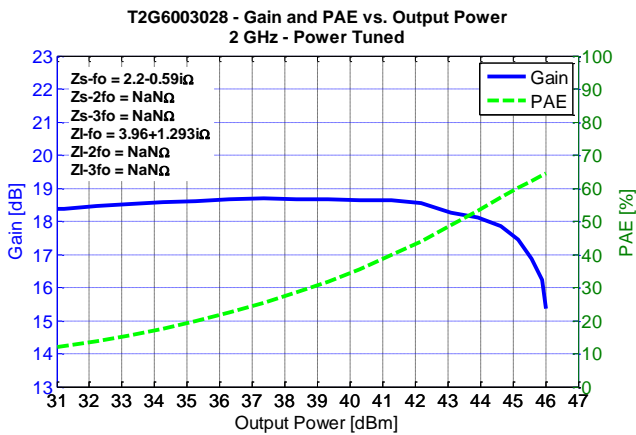
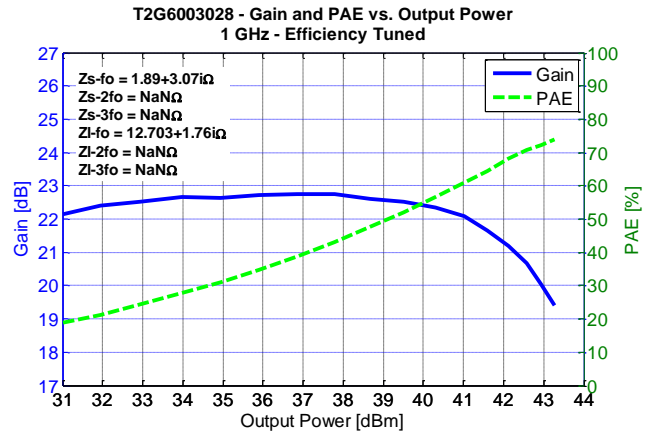
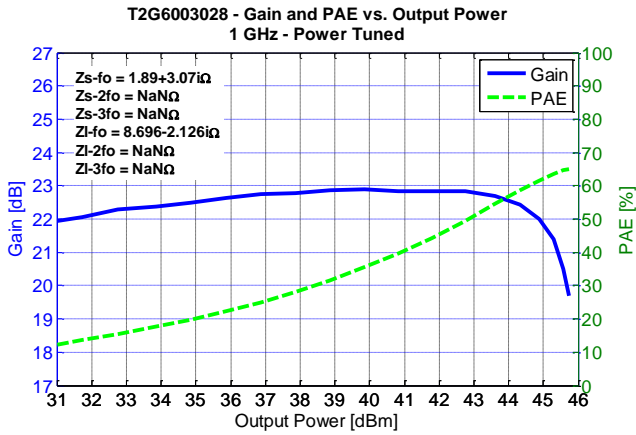

### Load Pull Drive-ups <sup>1,2</sup>

Notes:

- Vd = 28 V, Idq = 200 mA, Pulse Width = 100 uS, Duty Cycle = 20%
- NaN means the parameter is either unavailable or undefined.

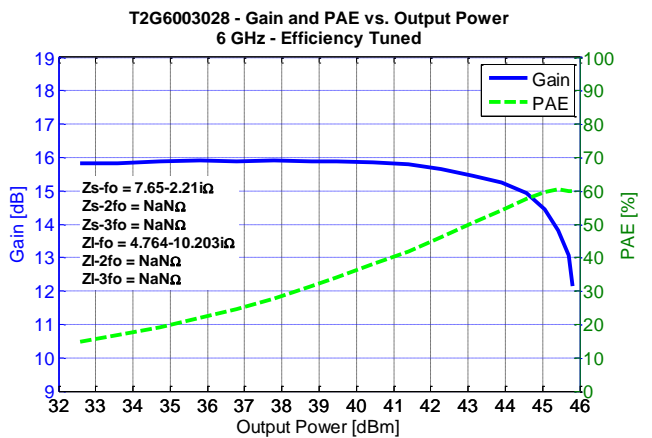
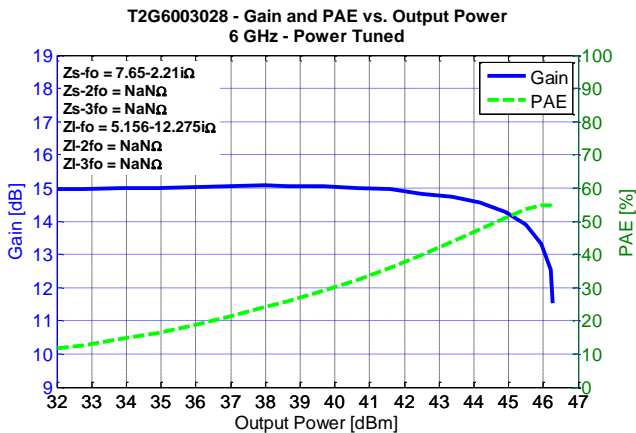
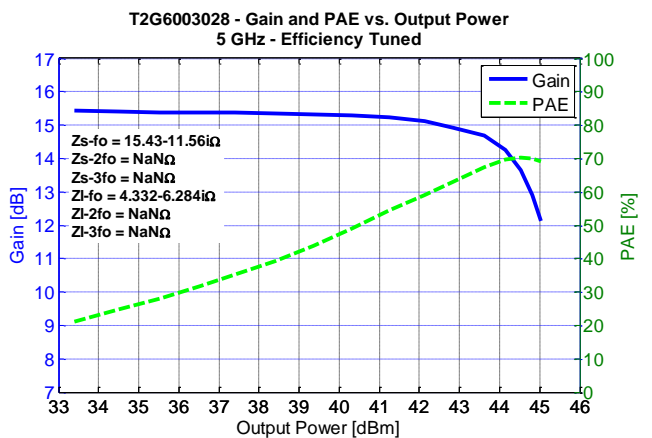
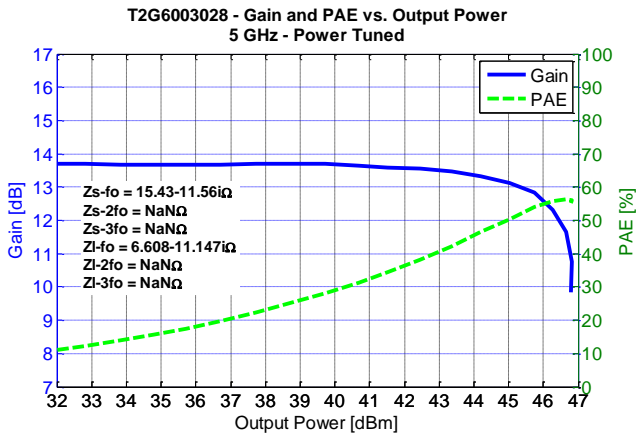
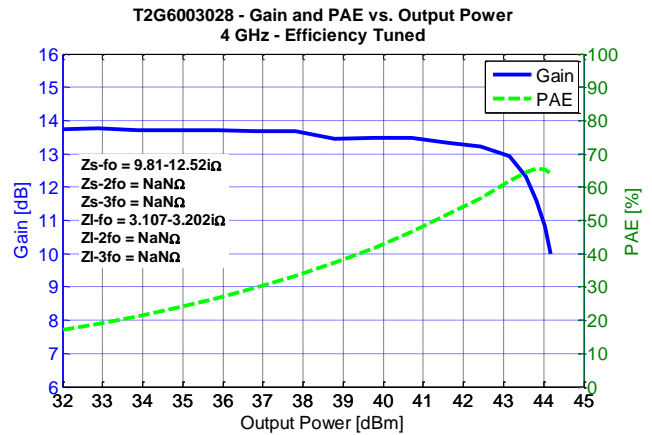
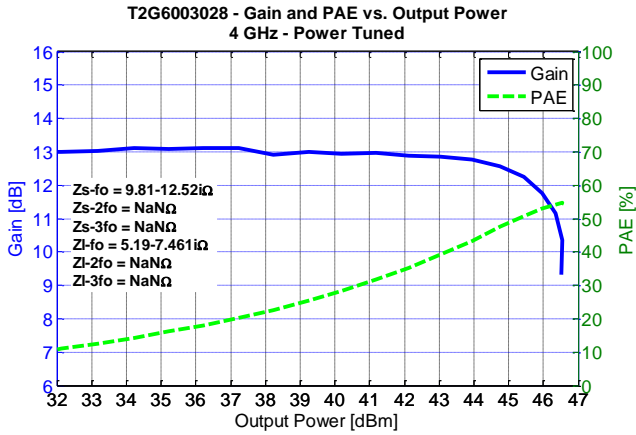

## Package Marking and Pin Configuration <sup>1</sup>

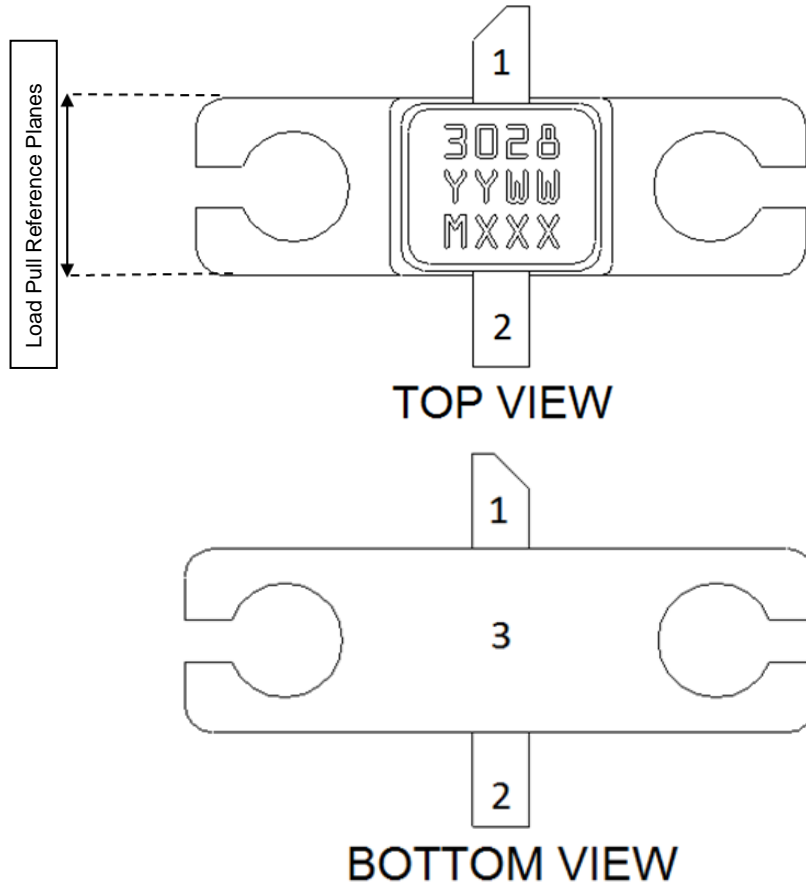

**Note:**

The T2G6003028-FL will be marked with the “30282” designator and a lot code marked below the part designator. The “YY” represents the last two digits of the calendar year the part was manufactured, the “WW” is the work week of the assembly lot start, and the “ZZZ” is an auto-generated number.

Pin	Symbol	Description
1	$V_D$ / RF OUT	Drain voltage / RF Output matched to 50 ohms; see EVB Layout on page 17 as an example.
2	$V_G$ / RF IN	Gate voltage / RF Input matched to 50 ohms; see EVB Layout on page 17 as an example.
3	Flange	Source connected to ground; see EVB Layout on page 17 as an example.

**Notes:**

Thermal resistance measured to bottom of package

### Package Dimensions

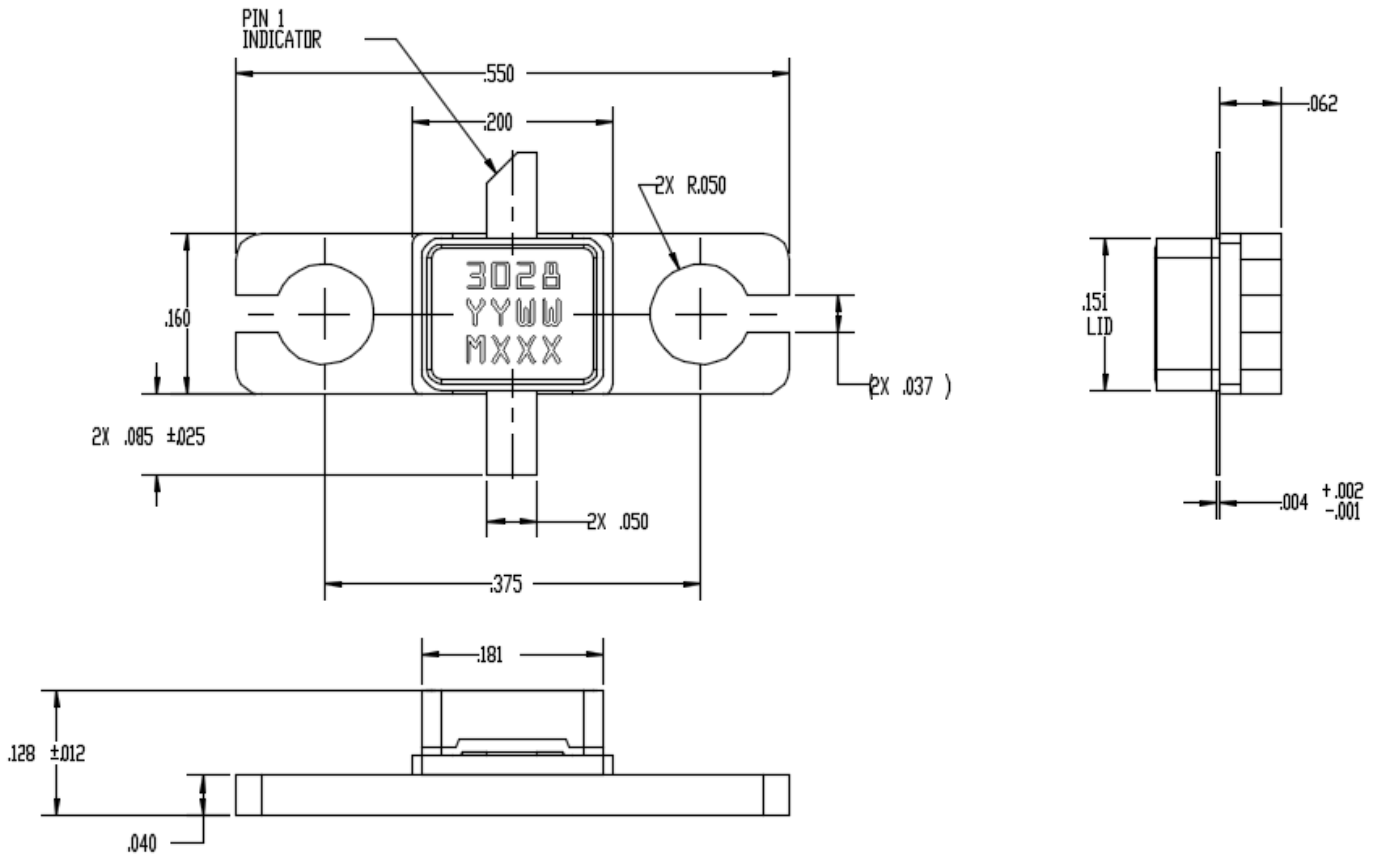

#### Notes:

1. Material:  
Package Base: Ceramic/Metal  
Package Lid: Ceramic
2. Part is epoxy sealed
3. All metalized features are gold plated
4. Part meets industry NI200 footprint
5. Body dimensions do not include lid shift or epoxy run out which can be up to 20 mils per side.
6. Dimensions are in inches. General tolerance is  $\pm 0.005$ ".

### Package Dimensions<sup>1-5</sup>

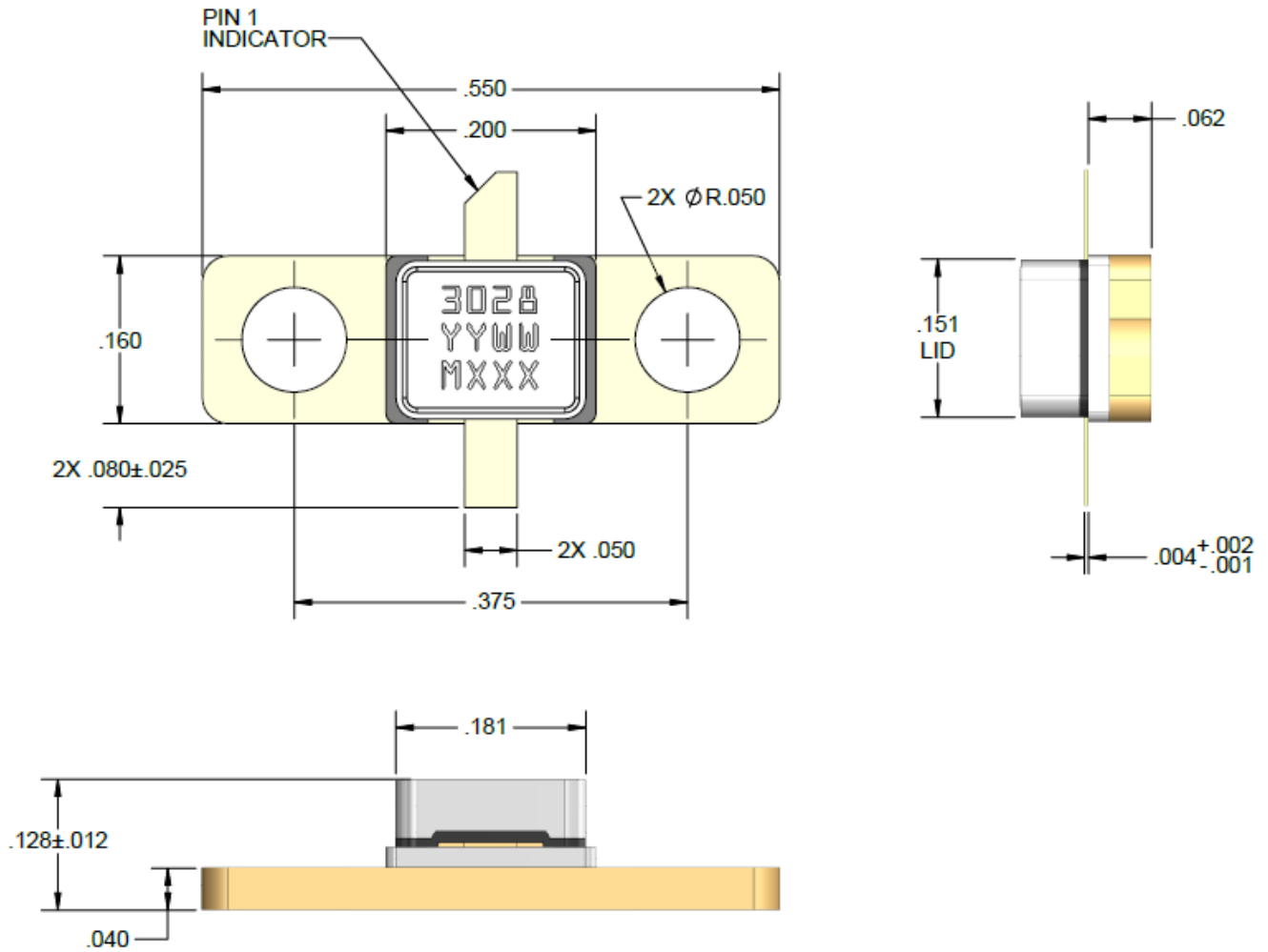

#### Notes:

1. Material:  
 Package Base: Ceramic/Metal  
 Package Lid: Ceramic
2. Part is epoxy sealed
3. All metalized features are gold plated
4. Part meets industry NI200 footprint
5. Body dimensions do not include lid shift or epoxy run out which can be up to 20 mils per side.
6. Dimensions are in inches. General tolerance is ±0.005".

### Application Circuit

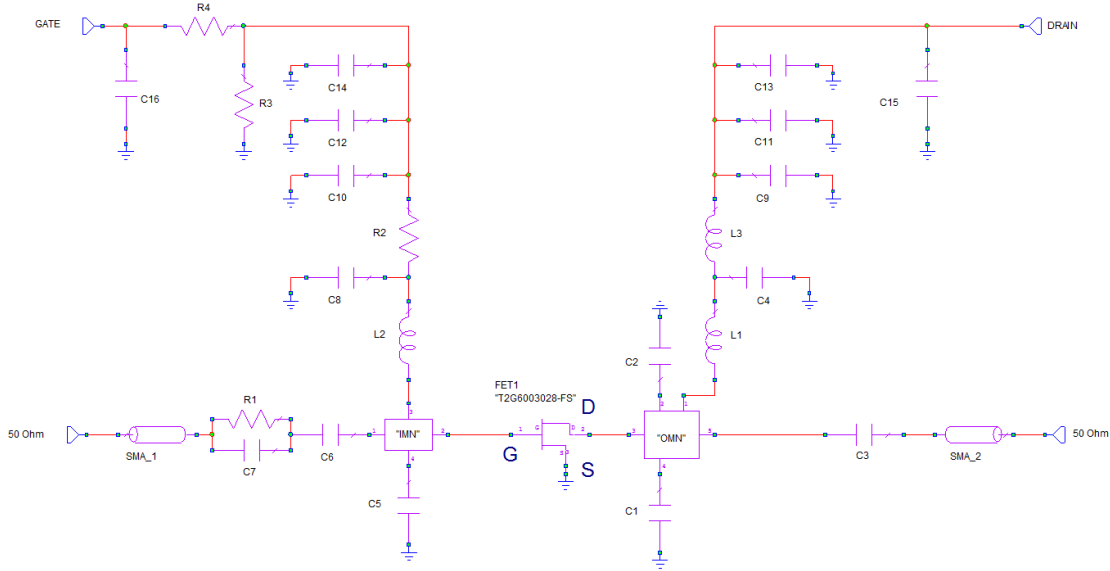

### Bias Procedure

Bias-up Procedure	Bias-down Procedure
1. Set $V_G$ to -5 V.	1. Turn off RF signal.
2. Set $I_D$ current limit to 220 mA.	2. Turn off $V_D$
3. Apply 28 V $V_D$ .	3. Wait 1 seconds to allow drain capacitor to discharge.
4. Slowly adjust $V_G$ until $I_D$ is set to 200 mA.	4. Turn off $V_G$
5. Set $I_D$ to 2.8 A.	
6. Apply RF signal	



### 5.4 – 5.9 GHz Evaluation Board– Layout <sup>1, 2, 3</sup>

Notes:

1. Top RF layer is 0.020" thick Rogers RO4350B,  $\epsilon_r = 3.48$
2. The pad pattern shown has been developed and tested for optimized assembly at Qorvo Semiconductor.
3. The PCB land pattern has been developed to accommodate lead and package tolerances

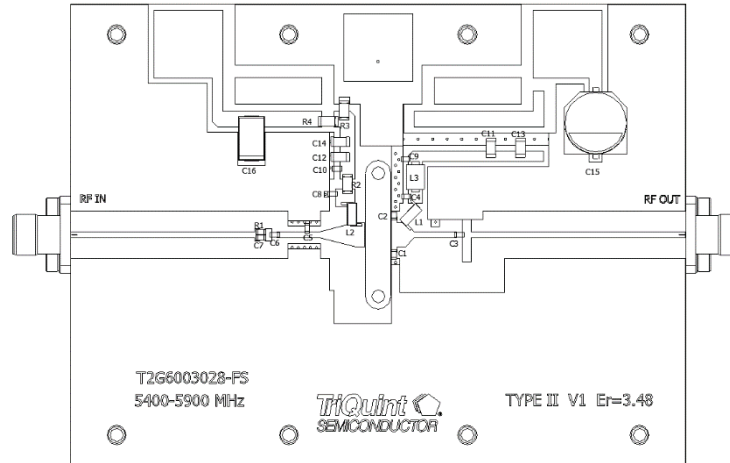

### 5.4 – 5.9 GHz Application Circuit – Bill of Materials EVB1

Ref Des	Qty	Description	Mfg Name	Mfg Part #
C1	1	0.3 pF	ATC	ATC600S0R3
C2	1	0.2 pF	ATC	ATC600S0R2
L1, L2	2	8.8 nH	COILCRAFT	1606-8
C3, C4, C6, C7, C8	5	3 pF	ATC	ATC600S3R0
C5	1	0.4 pF	ATC	ATC600S0R5
R1	1	97.6 Ohms	Venkel	CR0604-16w-97R6FT
R2	1	4.7 Ohms	Newark	37C0064
R3	1	330 Ohms	Newark	TNPW1206330RBT9ET1-E3
R4	1	50 Ohms	ATC	CRCW120651R0FKEA
C9, C10	2	220 pF	AVX	AVX06035C22KAT2A
C11, C12	2	2200 pF	Vitramon	VJ1206Y222KXA
C13, C14	2	22000 pF	Vitramon	VJ1206Y223KXA
C15	1	220 uF	United Chemi-Con	EMVY500ADA221MJA0G
C16	1	1.0 uF	Allied	541-1231
L3	1	48 Ohm	Ferrite, Laird Tech.	28F0121-0SR-10

### Evaluation Board Performance <sup>1, 2, 3</sup>

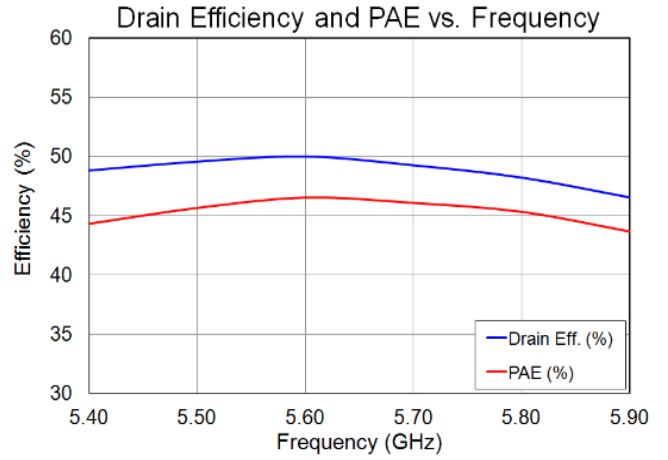
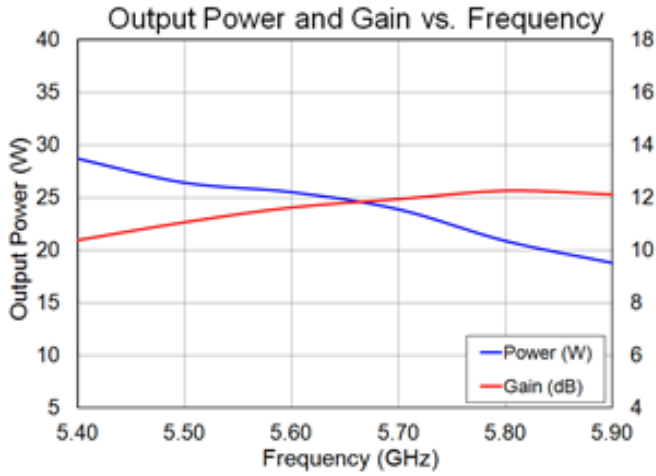

Notes:

1. Test Conditions:  $V_{DS} = 28\text{ V}$ ,  $I_{DQ} = 200\text{ mA}$
2. Test Signal: Pulse Width =  $100\text{ }\mu\text{s}$ , Duty Cycle = 20 %
3. Performance at 3dB compression.

### Performance over Temperatures of 5.4 – 5.9 GHz EVB <sup>1, 2</sup>

Notes:

1. Test Conditions:  $V_D = 28\text{ V}$ ,  $I_{DQ} = 200\text{ mA}$ , 100 us Pulse Width, 20% Duty Cycle.
2. Performance at 3dB compression.

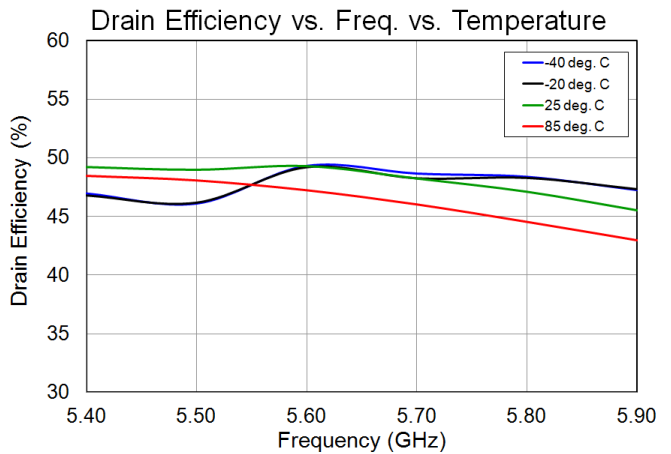
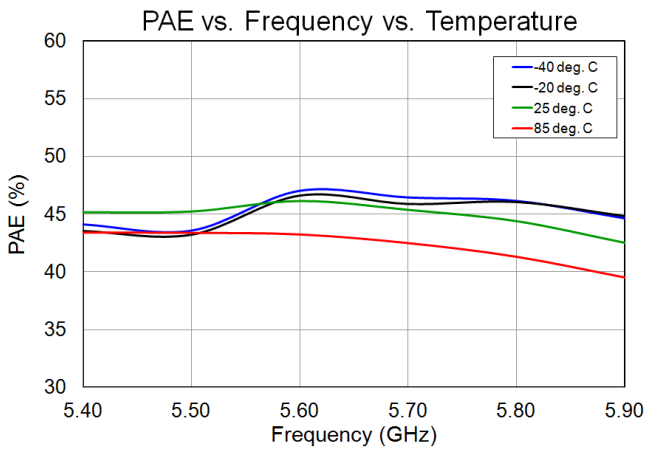
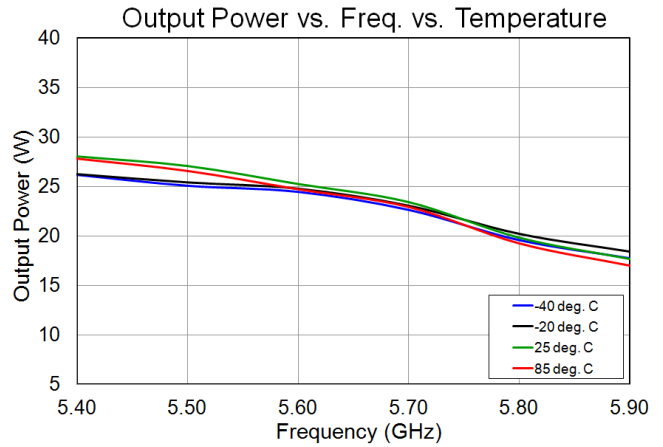
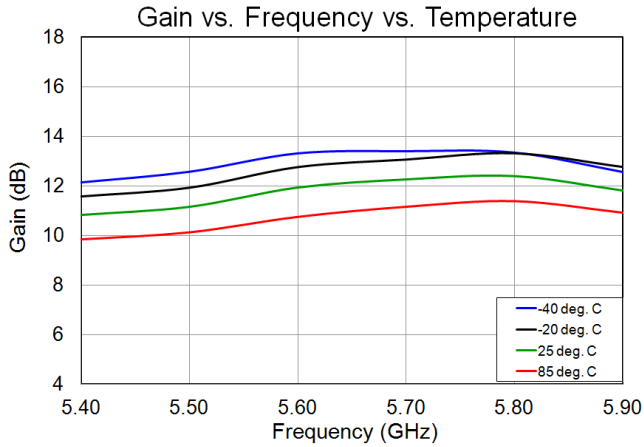

**Recommended Solder Temperature Profile**

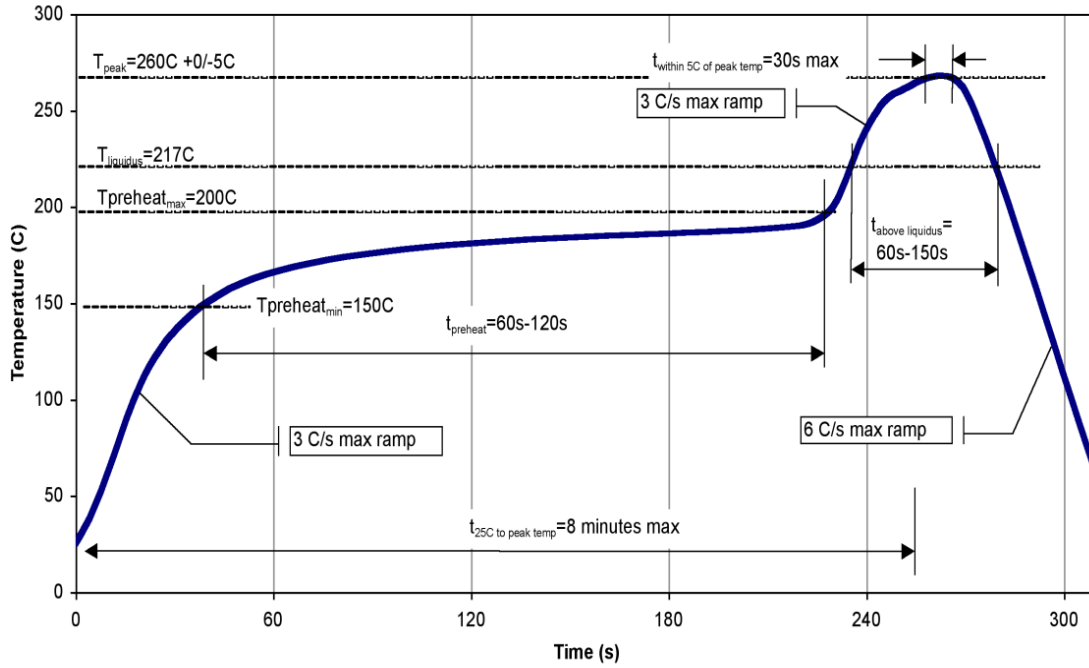

### Handling Precautions

Parameter	Rating	Standard
ESD – Human Body Model (HBM)	Class 1A (250V)	JEDEC JESD22-A114
ESD – Charged Device Model (CDM)	Class C3 (1000V)	JEDEC JS-002
MSL – Moisture Sensitivity Level	MSL3	JESD J-STD-020



Caution!  
ESD-Sensitive Device

### Solderability

Compatible with both lead-free (260°C max. reflow temp.) and tin/lead (245°C max. reflow temp.) soldering processes. Solder profiles available upon request. The use of no-clean solder to avoid washing after soldering is recommended. Contact plating: NiAu. Minimum Au thickness is 60 µinches.

### RoHS Compliance

This part is compliant with 2011/65/EU RoHS directive (Restrictions on the Use of Certain Hazardous Substances in Electrical and Electronic Equipment) as amended by Directive 2015/863/EU.

This product also has the following attributes:

- Halogen Free (Chlorine, Bromine)
- Antimony Free
- TBBP-A (C<sub>15</sub>H<sub>12</sub>Br<sub>4</sub>O<sub>2</sub>) Free
- PFOS Free
- SVHC Free

### Contact Information

For the latest specifications, additional product information, worldwide sales and distribution locations:

**Web:** [www.qorvo.com](http://www.qorvo.com)

**Tel:** 1-844-890-8163

**Email:** [customer.support@qorvo.com](mailto:customer.support@qorvo.com)

### Important Notice

The information contained herein is believed to be reliable; however, Qorvo makes no warranties regarding the information contained herein and assumes no responsibility or liability whatsoever for the use of the information contained herein. All information contained herein is subject to change without notice. Customers should obtain and verify the latest relevant information before placing orders for Qorvo products. The information contained herein or any use of such information does not grant, explicitly or implicitly, to any party any patent rights, licenses, or any other intellectual property rights, whether with regard to such information itself or anything described by such information. **THIS INFORMATION DOES NOT CONSTITUTE A WARRANTY WITH RESPECT TO THE PRODUCTS DESCRIBED HEREIN, AND QORVO HEREBY DISCLAIMS ANY AND ALL WARRANTIES WITH RESPECT TO SUCH PRODUCTS WHETHER EXPRESS OR IMPLIED BY LAW, COURSE OF DEALING, COURSE OF PERFORMANCE, USAGE OF TRADE OR OTHERWISE, INCLUDING THE IMPLIED WARRANTIES OF MERCHANTABILITY AND FITNESS FOR A PARTICULAR PURPOSE.**

Without limiting the generality of the foregoing, Qorvo products are not warranted or authorized for use as critical components in medical, life-saving, or life-sustaining applications, or other applications where a failure would reasonably be expected to cause severe personal injury or death.

Copyright 2021 © Qorvo, Inc. | Qorvo is a registered trademark of Qorvo, Inc.