

Thyristors

T430



Technical Data

Typical applications : D.C. Motor control, Controlled rectifiers, A.C. Controllers

Type No.	V_{RRM} (Volts)	V_{RSM} (Volts)
T430/14	1400	1500
T430/16	1600	1700
T430/18	1800	1900
T430/22	2200	2300
T430/26	2600	2700
T430/29	2900	3000

Features

- Ceramic Header
- Voltage grade upto 2900V
- Weight 550 gm (Approx)

Symbol	Conditions	Values
$I_{T(AV)}$	Half wave resistive load; $T_{case} = 68\text{ }^{\circ}\text{C}$	430 A
I_{TSM}	$T_{vj} = 125\text{ }^{\circ}\text{C}$; 10 ms half sine, $V_R = 50\% V_{RRM}$	9000 A
I^2t	$T_{vj} = 125\text{ }^{\circ}\text{C}$; 10 ms half sine	405000 A^2s
	$T_{vj} = 125\text{ }^{\circ}\text{C}$; 3 ms half sine	315000 A^2s
I_{GT}	$T_{vj} = 25\text{ }^{\circ}\text{C}$; $V_{DRM} = 5\text{V}$	150 mA
V_{GT}	$T_{vj} = 25\text{ }^{\circ}\text{C}$; $V_{DRM} = 5\text{V}$	3.5 V
dv/dt	$T_{vj} = 125\text{ }^{\circ}\text{C}$; Voltage = 67 % V_{DRM}	*200 V/ μs
$[di/dt]_{CR}$	Repetitive 50 Hz	100 A/ μs
V_T	$T_{vj} = 25\text{ }^{\circ}\text{C}$; $I_T = 1600\text{A}$	1.80 V max
V_0	$T_{vj} = 125\text{ }^{\circ}\text{C}$	0.96 V
R_0	$T_{vj} = 125\text{ }^{\circ}\text{C}$	0.35 m
I_{RRM}/I_{DRM}	$T_{vj} = 125\text{ }^{\circ}\text{C}$	50 mA
I_H	Typ. value.	80 mA
I_L	Typ. value.	100 mA
$R_{th(j-h)}$	dc	0.070 $^{\circ}\text{C/W}$
	Half wave	0.073 $^{\circ}\text{C/W}$
	3-Phase	0.084 $^{\circ}\text{C/W}$
T_{vj}		+ 125 $^{\circ}\text{C}$
T_{stg}		-40.....+ 125 $^{\circ}\text{C}$
Mounting torque		15 Nm per Bolt
Case outline		S

* Higher dv/dt selection available on request



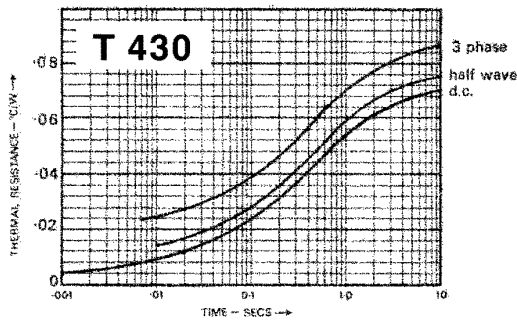
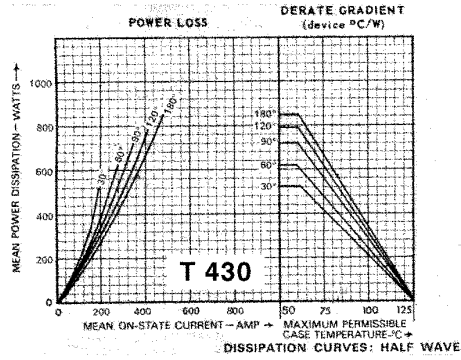
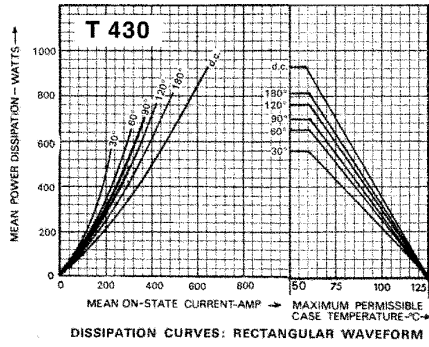

MAXIMUM (LIMIT) TRANSIENT THERMAL RESISTANCE

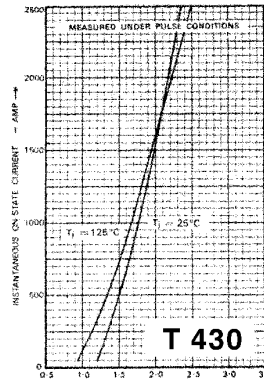

MAXIMUM (LIMIT) ON-STATE CHARACTERISTICS

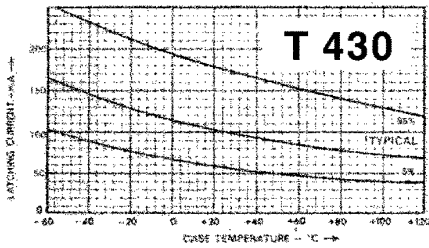

LATCHING CURRENT VERSUS CASE TEMPERATURE

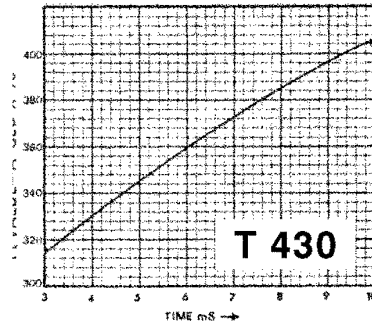

I²t VERSUS TIME AT 125°C

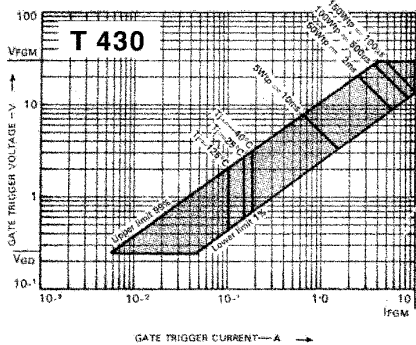

GATE CHARACTERISTICS

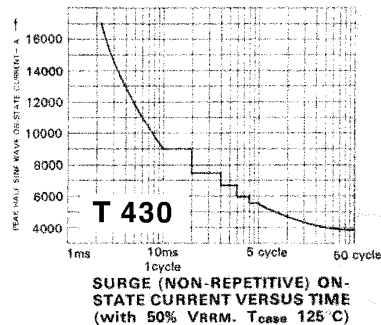

PACAKAGE DEATILS

DO NOT SCALE

All Dimensions in mm

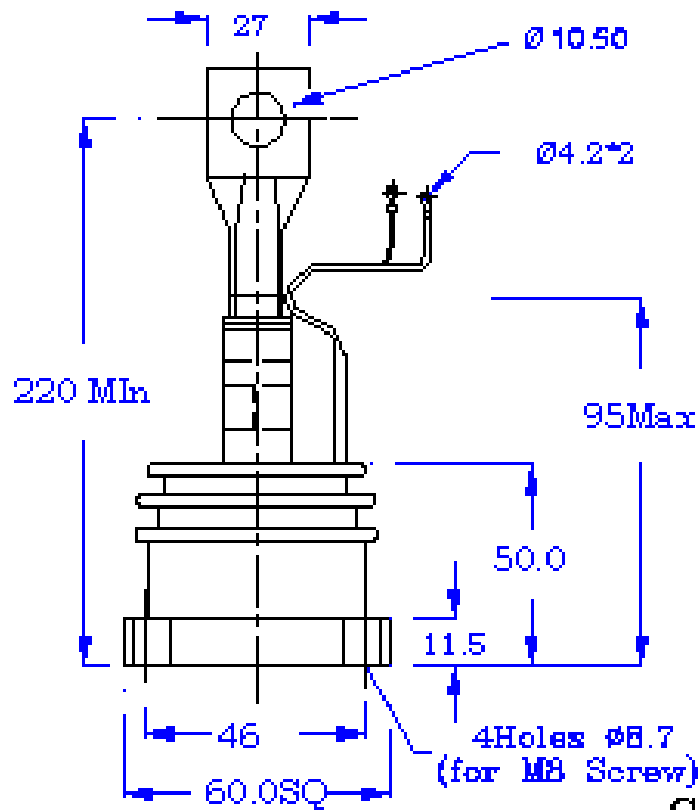

Mounting Torque 15Nm/Bolt^S