

TOSHIBA BIPOLAR LINEAR INTEGRATED CIRCUIT SILICON MONOLITHIC

# TA2002F, TA2002FN

## STEREO HEADPHONE AMPLIFIER (3V USE)

The TA2002F, TA2002FN are developed for play-back stereo headphone equipments (3V use).

They are built in dual auto-reverse preamplifier, dual OCL power amplifier, and a ripple filter.

### FEATURES

#### Power amplifier stage

- OCL (Output Condenser-Less)
- Low noise :  $V_{no} = 22\mu V_{rms}$  (Typ.)
- Excellent ripple rejection ratio :  $RR = 62dB$  (Typ.)
- Voltage gain :  $G_V = 27dB$  (Typ.)
- Built-in a power amplifier mute
- Built-in input capacitor for reducing buzz noise

#### Preamplifier stage

- Auto-reverse with F/R control switch
- Input coupling condenser-less
- Low noise :  $V_{ni} = 1.3\mu V_{rms}$  (Typ.)
- Built-in a preamplifier mute
- Built-in input capacitor for reducing buzz noise

#### Total

- Built-in a ripple filter
- Built-in a power switch
- Low quiescent current :  $I_{CCQ} = 11.5mA$  (Typ.) ( $V_{CC} = 3V$ ,  $T_a = 25^\circ C$ )
- Operating supply voltage range :  $V_{CC(opr)} = 1.8\sim 4.5V$  ( $T_a = 25^\circ C$ )

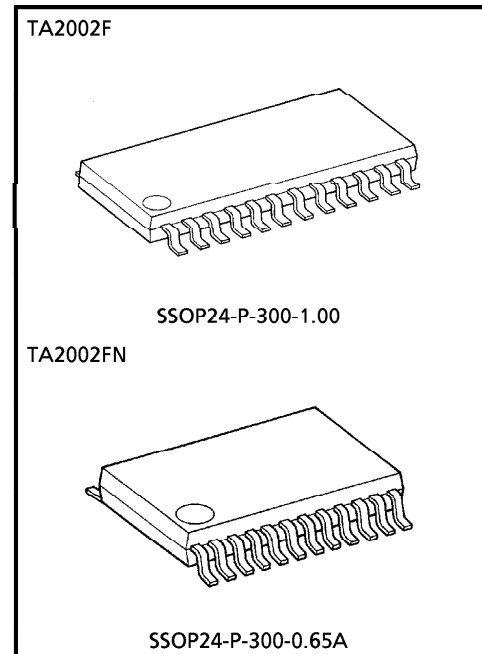

#### Weight

SSOP24-P-300-1.00	: 0.32g (Typ.)
SSOP24-P-300-0.65A	: 0.14g (Typ.)

961001EBA2

- TOSHIBA is continually working to improve the quality and the reliability of its products. Nevertheless, semiconductor devices in general can malfunction or fail due to their inherent electrical sensitivity and vulnerability to physical stress. It is the responsibility of the buyer, when utilizing TOSHIBA products, to observe standards of safety, and to avoid situations in which a malfunction or failure of a TOSHIBA product could cause loss of human life, bodily injury or damage to property. In developing your designs, please ensure that TOSHIBA products are used within specified operating ranges as set forth in the most recent products specifications. Also, please keep in mind the precautions and conditions set forth in the TOSHIBA Semiconductor Reliability Handbook.
- The products described in this document are subject to foreign exchange and foreign trade control laws.
- The information contained herein is presented only as a guide for the applications of our products. No responsibility is assumed by TOSHIBA CORPORATION for any infringements of intellectual property or other rights of the third parties which may result from its use. No license is granted by implication or otherwise under any intellectual property or other rights of TOSHIBA CORPORATION or others.
- The information contained herein is subject to change without notice.

BLOCK DIRGRAM

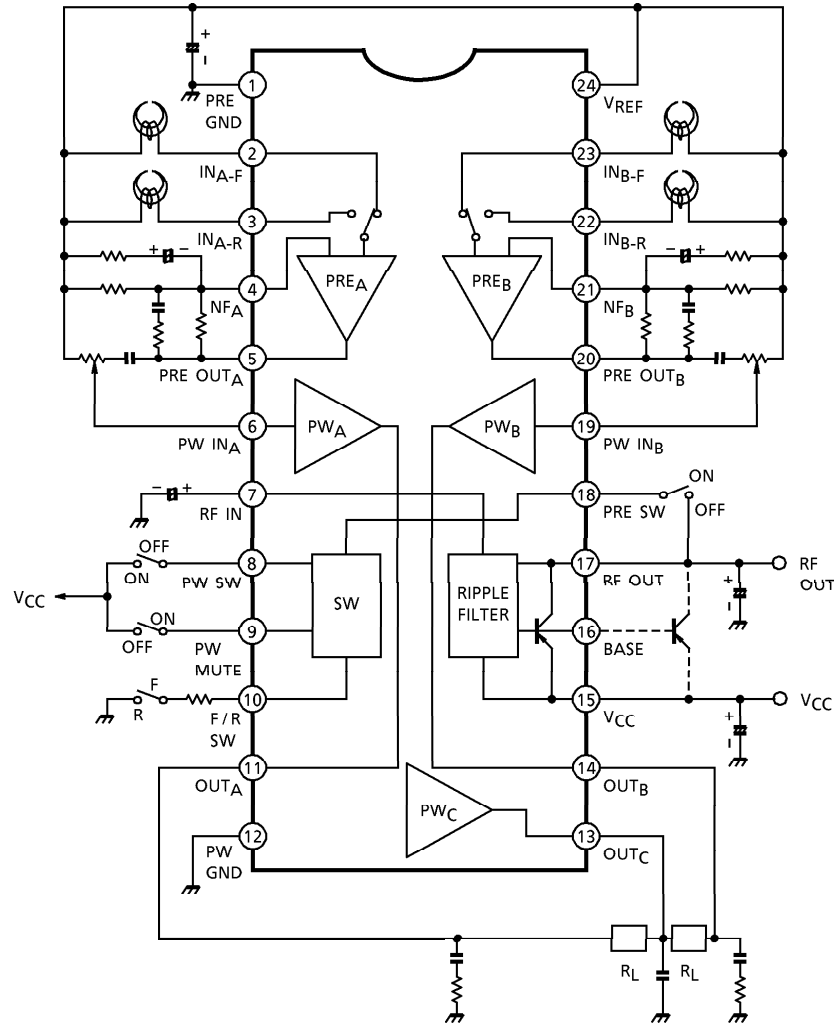

**TERMINAL EXPLANATION**

Terminal voltage : Typical terminal voltage at no signal with test circuit ( $V_{CC} = 3V$ ,  $T_a = 25^\circ C$ )

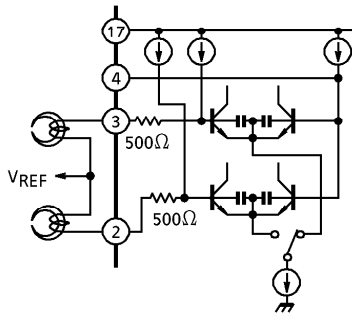
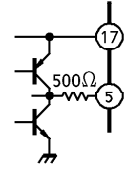
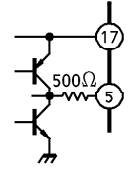
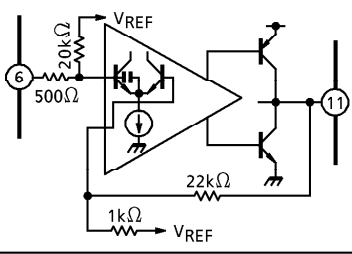
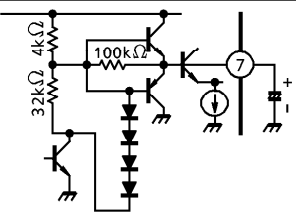
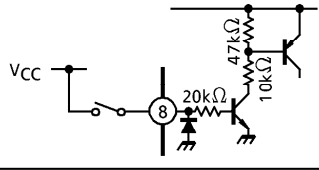
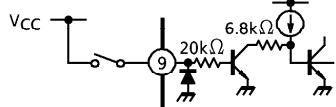
TERMINAL		FUNCTION	INTERNAL CIRCUIT	TERMINAL VOLTAGE (V)	
No.	NAME				
1	PRE GND	The GND, except the power drive stage.	—	0	
2	IN <sub>A-F</sub>	Input of preamplifier. F/R SW ( OPEN : ② / ⑳PIN "L" : ③ / ㉔PIN		1.3	
3	IN <sub>A-R</sub>				
22	IN <sub>B-R</sub>				
23	IN <sub>B-F</sub>				
4	NFA	NF of preamplifier.		1.3	
21	NFB				
5	PRE OUT <sub>A</sub>	Output of preamplifier.		1.3	
20	PRE OUT <sub>B</sub>				
6	PW IN <sub>A</sub>	Input of power amplifier.		1.3	
19	PW IN <sub>B</sub>				
11	OUT <sub>A</sub>			Output of power amplifier.	1.3
14	OUT <sub>B</sub>				
7	RF IN	Ripple filter terminal.		2.6	
8	PW SW	Power on / off switch. ( $V_{CC}$ : Power on OPEN or GND : Power off		—	
9	PW MUTE	Muting switch for power amplifier. ( $V_{CC}$ : Power amp. on OPEN or GND : Power amp. off		—	

TERMINAL		FUNCTION	INTERNAL CIRCUIT	TERMINAL VOLTAGE (V)
No.	NAME			
10	F/R SW	<p>Forward / Reverse mode switch.                      ( OPEN : Forward mode                      "L" level : Reverse mode                      ※ <u>This terminal can't be connected with GND line directly.</u>                      In case of reverse mode, a resistor (<math>R = 180k\Omega \sim 270k\Omega</math>) should be connected to GND.</p>		—
12	PW GND	GND for power drive stage.	—	0
13	OUT <sub>C</sub>	Output terminal of center power amplifier.		1.3
15	V <sub>CC</sub>	—	—	3
16	BASE	Base bias of an external PNP transistor for ripple filter.		2.3
17	RF OUT	<p>Ripple filter output.                      Ripple filter circuit supplies internal circuit except power amplifier circuit with power source.</p>		2.6
18	PRE SW	<p>Muting switch for preamplifier.                      ( V<sub>17</sub> (RF OUT) : Preamp. off                      OPEN : Preamp. on                      ※ <u>This terminal can't be connected with GND line directly.</u>                      In case that terminal is connected with GND line, a resistor (<math>R \geq 10k\Omega</math>) should be connected to GND.</p>		—
24	V <sub>REF</sub>	<p>Reference voltage.                      Preamplifier and power amplifier operate on this reference.</p>		1.3

**APPLICATION NOTE**

(1) PW SW

It is necessary to connect an external pull-down resistor with the terminal PW SW (pin⑨), in case that this IC is turned on due to external noise etc.

(2) PW MUTE

The leak current flows through the terminal of PW MUTE (pin⑨), in case that the terminal is connected with  $V_{CC}$  line independently, even though this IC is off-mode (the terminal of PW SW (pin⑨) is off-mode).

It is advised to connect  $R_1$  and  $C$  with the terminal of PW MUTE, to reduce a pop sound in switchover between PW MUTE on/off. And it is advised to connect  $R_2$ , to shorten a switchover time from PW MUTE off-mode to PW MUTE on-mode (see Fig.1). It is better that the constants are  $R_1 \cong R_2 \cong 100k\Omega$ ,  $C \cong 1\mu F$  at  $V_{CC} = 3V$ .

As for the constants, select the optimum one depending on each a set carefully.

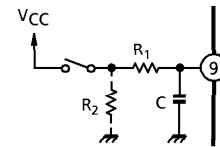

Fig.1 PW MUTE circuit reducing a pop sound

(3) F/R SW

The terminal of F/R SW (pin⑩) should not be applied to higher voltage than  $V_{17}$  (RF OUT), because the ripple filter circuit supplies the F/R SW circuit with power source. And in reverse mode, the terminal of F/R SW should be connected with GND line through  $R_3$  ( $180\sim 270k\Omega$ ), because the F/R SW circuit doesn't operate normally. It is advised to connect an external capacitor ( $C_3 \cong 1\mu F$ ), in order to reduce a pop sound in switchover between F/R mode (see Fig.2). As for the constants, select the optimum one depending on each a set carefully.

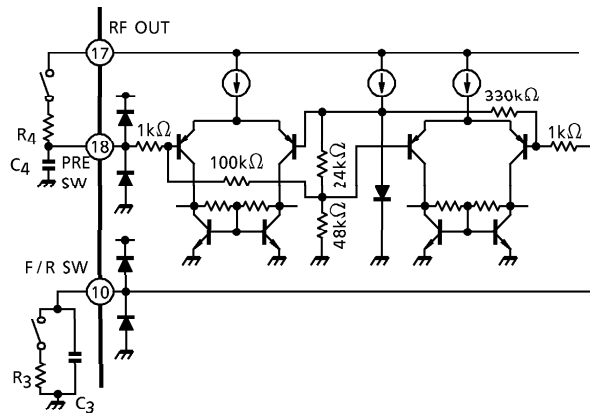

Fig.2 Internal equivalent circuit of F/R SW and PRE SW and the external circuits reducing a pop sound in switchover

In controlling the F/R SW with voltage source, it is applied as follows ;

- ( Forward mode : 0.8V~V<sub>17</sub> (RF OUT)
- ( Reverse mode : 0.15~0.35V

(4) PRE SW

The terminal of PRE SW (pin<sup>18</sup>) should not be applied to higher voltage than V<sub>17</sub> (RF OUT), because ripple filter circuit supplies the PRE SW circuit with power source. And this terminal can't be connected with GND line directly, because the PRE SW circuit doesn't operate normally.

In case of preamplifier on-mode, this terminal should be opened or connected with GND line through a resistor ( $R \geq 10k\Omega$ ).

It is advised to connect a external resistor ( $R_4 = 100 \sim 330k\Omega$ ) and capacitor ( $C_4 \doteq 1\mu F$ ), in order to reduce a pop sound in switchover between PRE SW on/off mode (see Fig.2). As for the constants, select the optimum one depending on each a set carefully.

In controlling the PRE SW with voltage source, it is applied as follows ;

- ( Preamplifier on-mode : 0.1~0.5V
- ( Preamplifier off-mode : 1.0V~V<sub>17</sub> (RF OUT)

(5) NF resistor of preamplifier

The NF resistor ( $R = 39k\Omega$  ; see the test circuit) should be connected, to reduce a pop sound.

(6) Input of power amplifier

In case that the volume of power amplifier is less than  $10k\Omega$ , it can be connected with power amplifier directly as Fig.3-1. In case more than  $10k\Omega$ , it is necessary to insert the coupling capacitor between volume and PW IN terminal as Fig.3-2. In case that DC current or DC voltage is applied to the terminal of PW IN, the internal circuit has unbalance and the power amplifier doesn't operate normally.

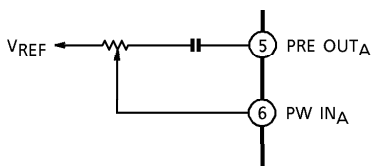

Fig.3-1 Volume connection (1)  
( $R \leq 10k\Omega$ )

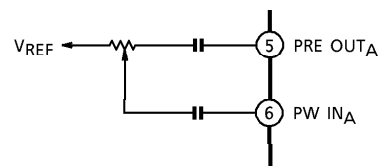

Fig.3-2 Volume connection (2)  
( $R > 10k\Omega$ )

## (7) Increase of ripple filter current

It is built in PNP transistor for a ripple filter, the current capacity is about 10mA.

Then this IC can be increased the current capacity of the ripple filter with an external transistor  $Q_X$  (exp. 2SA1362). In this case, as the current gain is up, it is necessary to connect external parts for phase-compensation (see Fig.4). And it is necessary to stabilize the ripple filter circuit carefully, because the ripple filter circuit supplies internal circuit except power amplifier circuit with power source.

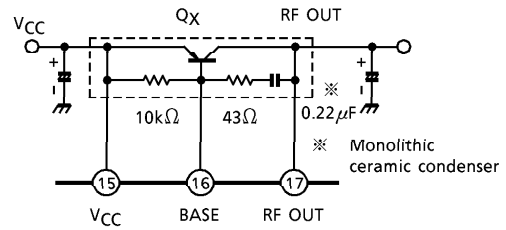

Fig.4 Increase of ripple filter current

## (8) Pattern layout

- The GND line of pin① (PRE GND) should be isolated from that of pin⑫ (PW GND) at the GND point, where the  $V_{CC}$  decoupling condenser is placed.
- The GND line of capacitor (for ripple filter) should be isolated from that of compensation capacitor, at the point of pin⑫ (PW GND).
- The pattern diagram between the pin⑭ ( $V_{REF}$ ) and capacitor should be made shortly. As for pin① (PRE GND), it's as well.
- The pattern diagram between the pin⑫ (PW GND) and compensation capacitor, should be shortly. And this positive line of compensation capacitor should be kept away from the terminals of PW IN, pin⑥, ⑨.
- The lines of PW IN should be kept away from those of PW OUT. And each of the PW OUT lines should be kept away.

※ See the example of pattern layout as shown next page.

## (9) Oscillation precaution

Small temperature coefficient and excellent frequency characteristic is needed by capacitors below.

- Oscillation preventing capacitors for power amplifier output.
- Bypass capacitor for ripple filter
- Capacitor between  $V_{CC}$  and GND
- Capacitor between  $V_{REF}$  and GND

AN EXAMPLE OF PATTERN LAYOUT

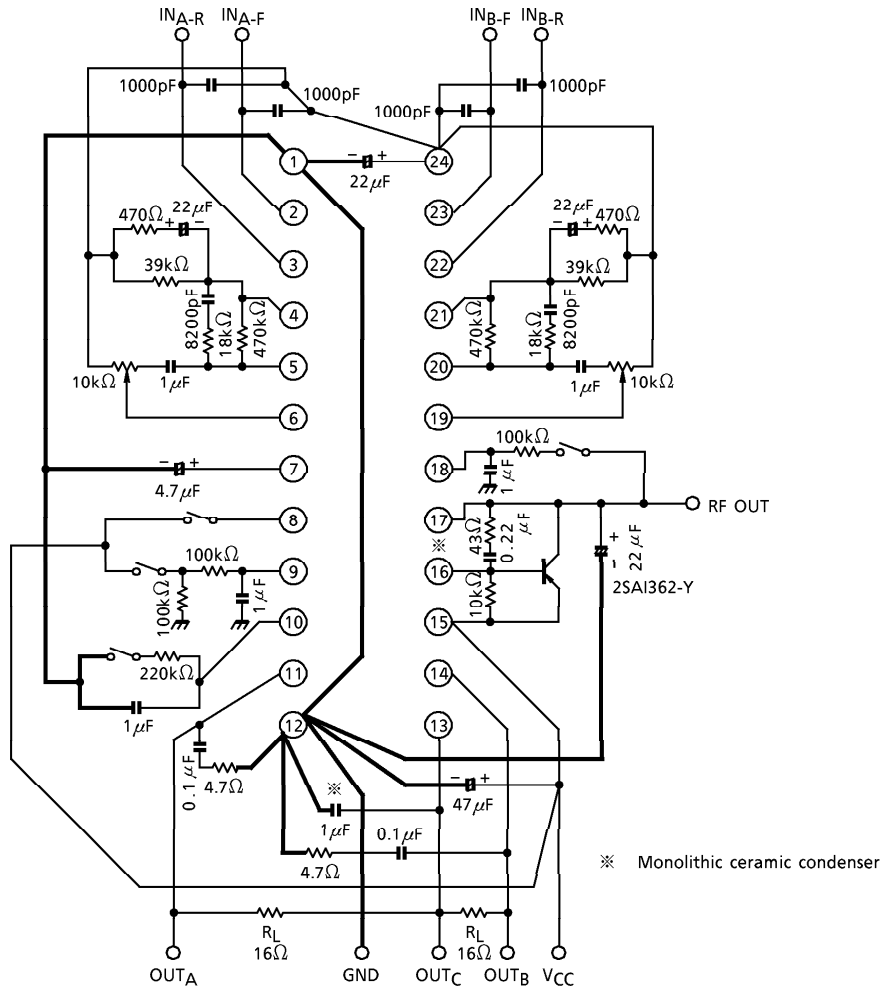

MAXIMUM RATINGS (Ta = 25°C)

CHARACTERISTIC	SYMBOL	RATING	UNIT
Supply Voltage	V <sub>CC</sub>	6	V
Output Current	Power	I <sub>o</sub> (peak)	60
	Ripple Filter	I <sub>RF</sub>	30
Power Dissipation	TA2002F	P <sub>D</sub> (Note)	400
	TA2002FN		500
Operating Temperature	T <sub>opr</sub>	- 25~75	°C
Storage Temperature	T <sub>stg</sub>	- 55~150	

(Note) Derated above Ta = 25°C in the proportion of 3.2mW/°C for TA2002F, and of 4mW/°C for TA2002FN.



**ELECTRICAL CHARACTERISTICS**

Unless otherwise specified :  $V_{CC} = 3V$ ,  $f = 1kHz$ ,  $T_a = 25^\circ C$ ,  $SW_1 : a$ ,  $SW_2 : a$ ,  $SW_3 : OPEN$ ,  $SW_8 : ON$

Preamplifier stage :  $R_g = 2.2k\Omega$ ,  $R_L = 10k\Omega$ ,  $SW_2 : OPEN$ ,  $SW_4 : ON / OPEN$ ,  $SW_5 : a / b$ ,

$SW_6 : a$

Power amplifier stage :  $R_g = 600\Omega$ ,  $R_L = 16\Omega$ ,  $SW_3 : ON$ ,  $SW_7 : a$

CHARACTERISTIC		SYM-BOL	TEST CIR-CUIT	TEST CONDITION	MIN.	TYP.	MAX.	UNIT	
Quiescent Current		$I_{CCQ1}$	—	Power off, $SW_1 : b$ , $SW_2 : b$ $SW_3 : ON$	—	—	5	$\mu A$	
		$I_{CCQ2}$		Power amp. off, $SW_2 : b$	—	5	9	mA	
		$I_{CCQ3}$		$V_{in} = 0$	—	11.5	16.5		
Power amplifier stage	Voltage Gain	$G_V$	—	$V_o = -12dBV$	25	27	29	dB	
	Channel Balance	CB			—	0	1.5		
	Output Power	$P_{O1}$		THD = 10%	$R_L = 16\Omega$	35	50	—	mW
		$P_{O2}$			$R_L = 32\Omega$	—	33	—	
	Total Harmonic Distortion	THD1		$P_o = 1mW$	—	0.2	0.8	%	
	Output Noise Voltage	$V_{no}$		$R_g = 600\Omega$ , $SW_7 : b$	—	22	40	$\mu V_{rms}$	
	Ripple Rejection Ratio	$RR_1$		$f_r = 100Hz$ , $V_r = -22dBV$ $SW_8 : OPEN$	45	62	—	dB	
	Cross Talk (CH-A / CH-B)	$CT_1$		$V_o = -12dBV$	35	42	—		
Power Muting Attenuation	ATT1	$V_o = -12dBV$ , $SW_2 : a \rightarrow b$	—	80	—				
Preamplifier stage	Open Loop Voltage Gain	$G_{VO}$	—	$V_o = -12dBV$ , $SW_6 : b$	70	80	—	dB	
	Closed Loop Voltage Gain	$G_{VC}$		$V_o = -12dBV$	—	35	—		
	Maximum Output Voltage	$V_{om}$		THD = 1%	600	850	—	$mV_{rms}$	
	Total Harmonic Distortion	THD2		$V_o = -12dBV$	—	0.02	0.1	%	
	Equivalent Input Noise Voltage	$V_{ni}$		$R_g = 2.2k\Omega$ , BPF = 20Hz~20kHz $SW_5 : c$ NAB ( $G_V = 35dB$ , $f = 1kHz$ )	—	1.3	2.8	$\mu V_{rms}$	
	Cross Talk (CH-A / CH-B)	$CT_2$		$V_o = -12dBV$	—	70	—	dB	
	Cross Talk (Forward / Reverse)	$CT_3$			—	70	—		
	Pre Muting Attenuation	ATT2			$V_o = -12dBV$ , $SW_3 : OPEN \rightarrow ON$	—	80		—
Ripple Filter Output Voltage		$V_{RF}$	—	$V_{CC} = 2V$ , $I_{RF} = 0mA$	1.76	1.8	—	V	
Ripple Rejection Ratio Of Ripple Filter Output		$RR_2$		$V_{CC} = 2V$ , $I_{RF} = 10mA$ $f_r = 100Hz$ , $V_r = -22dBV$ $SW_8 : OPEN$	45	53	—	dB	
Power On / Off Switch	Power On Current	$I_8$	—	$V_{CC} = 1.8V$ , $V_{24} \geq 0.5V$	5	—	—	$\mu A$	
	Power Off Voltage	$V_8$		$V_{CC} = 1.8V$ , $V_{24} \leq 0.3V$	0	—	0.3	V	
Power Amp. Mute Switch	Mute Off Current	$I_9$	—	$V_{CC} = 1.8V$ , $ATT1 \leq 3dB$	5	—	—	$\mu A$	
	Mute On Voltage	$V_9$		$V_{CC} = 1.8V$ , $ATT1 \geq 60dB$	0	—	0.3	V	

TEST CIRCUIT

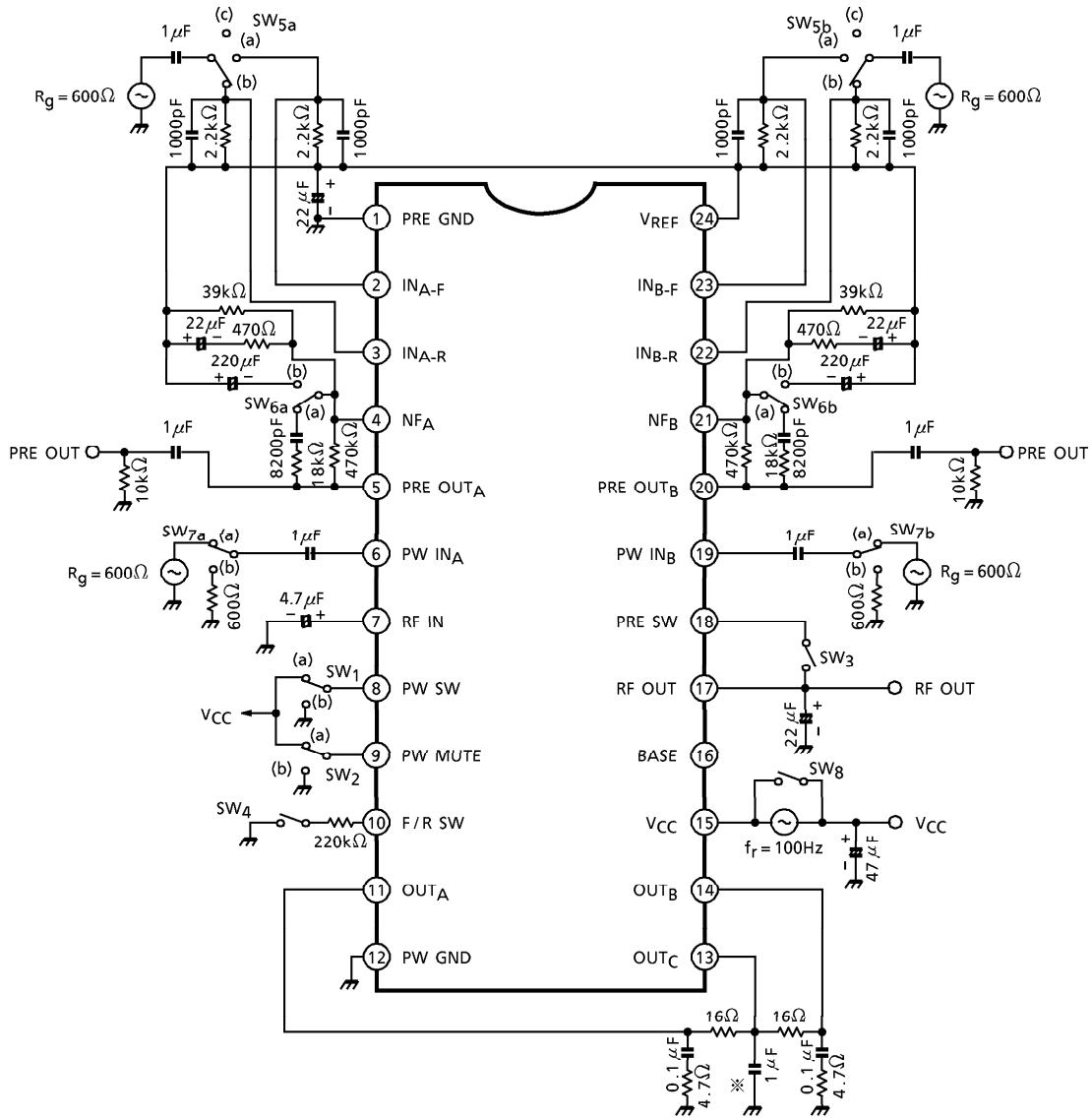

※ Monolithic ceramic condenser

**CHARACTERISTICS CURVES**

Unless otherwise specified :  $V_{CC} = 3V$ ,  $f = 1kHz$ ,  $T_a = 25^\circ C$   
 power amplifier stage :  $R_g = 600\Omega$ ,  $R_L = 16\Omega$   
 preamplifier stage :  $R_g = 2.2k\Omega$ ,  $R_L = 10k\Omega$

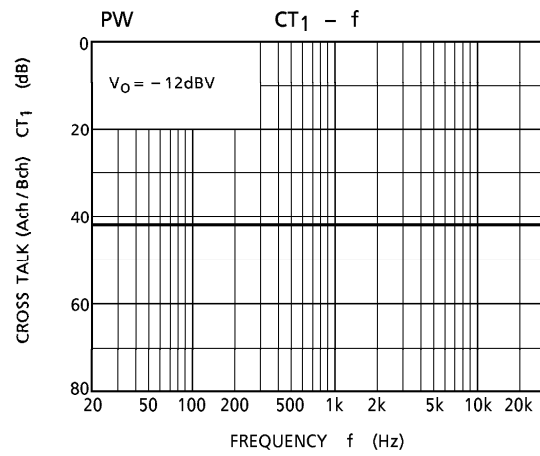
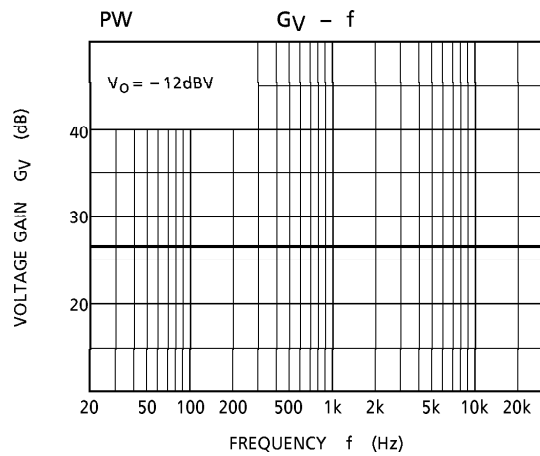
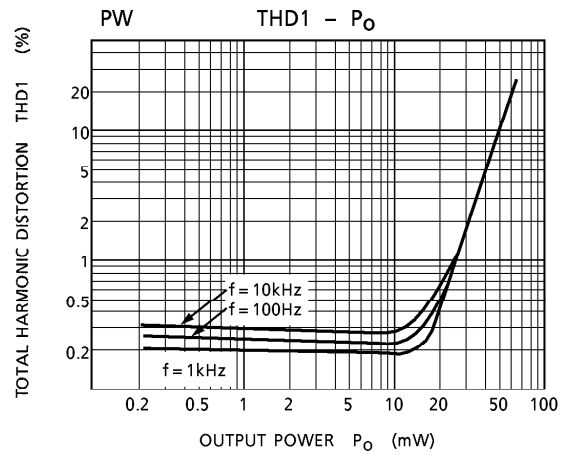
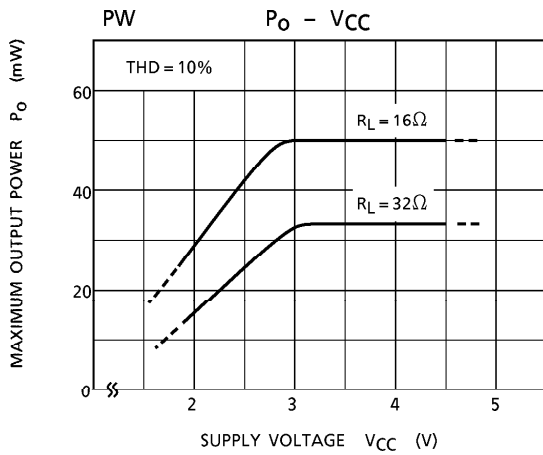
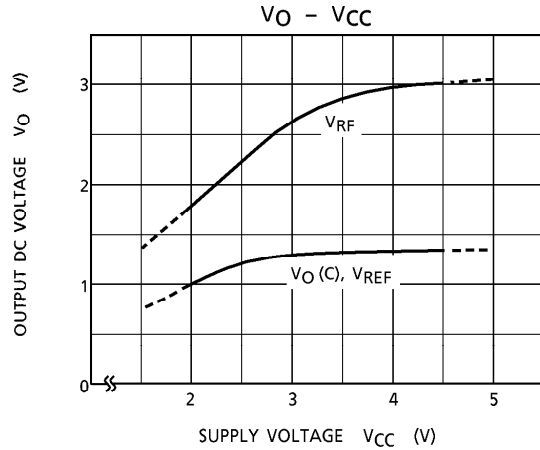
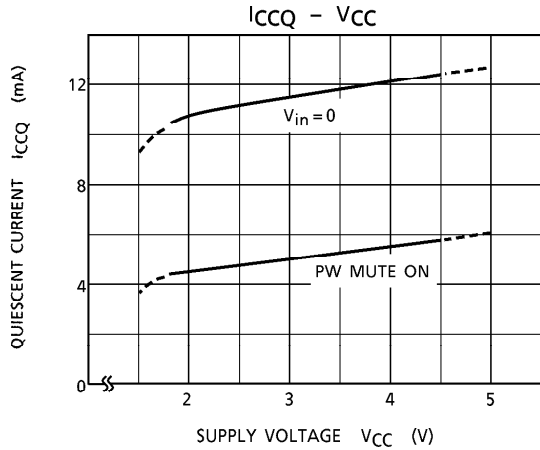

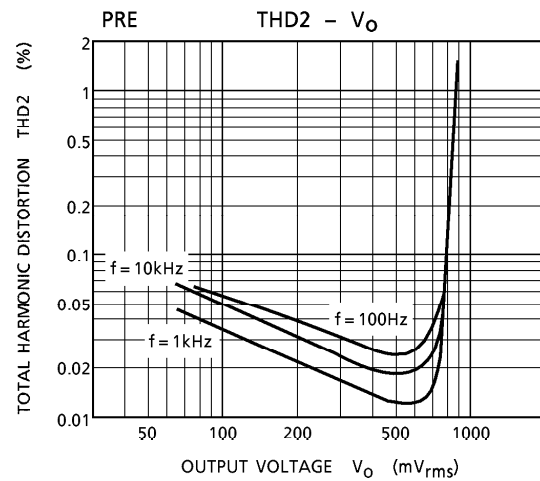
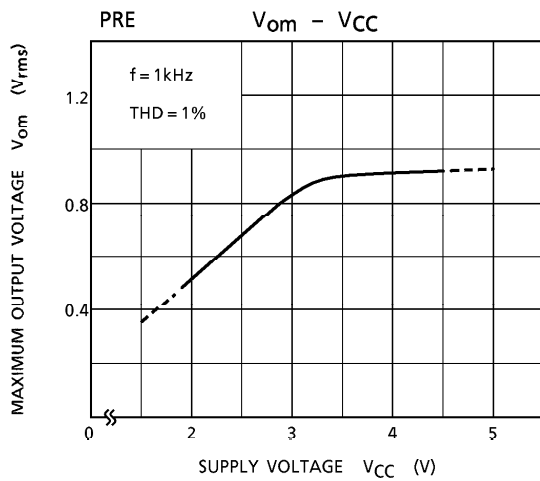
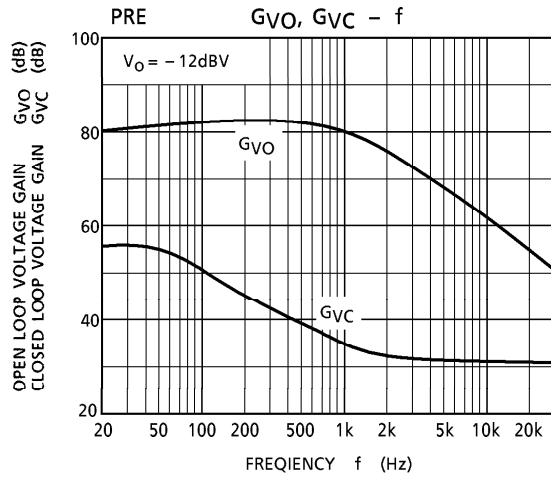
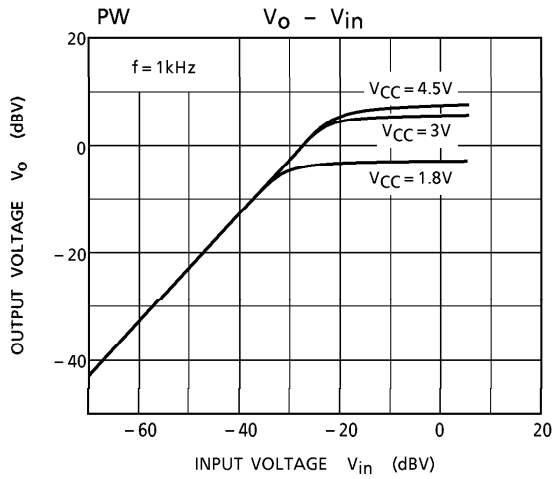
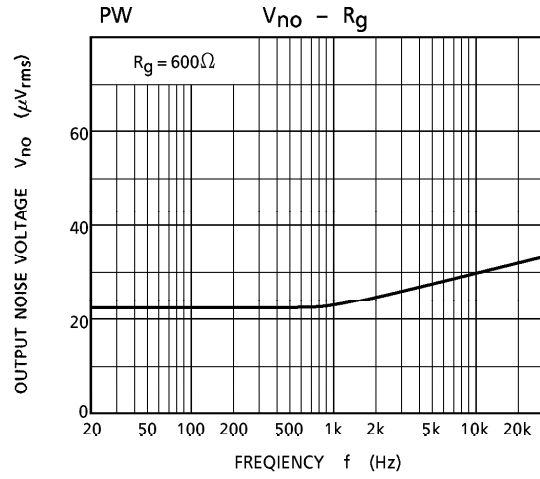
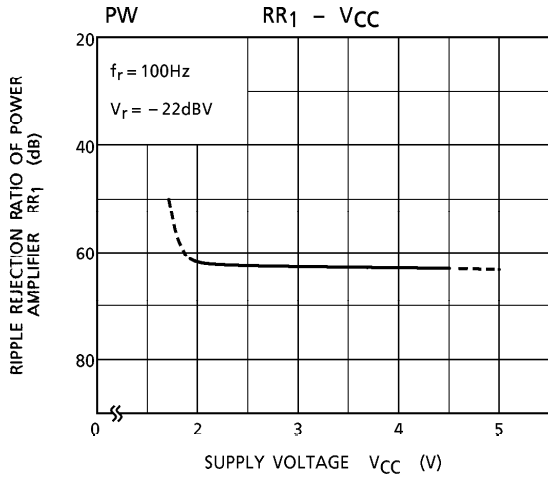

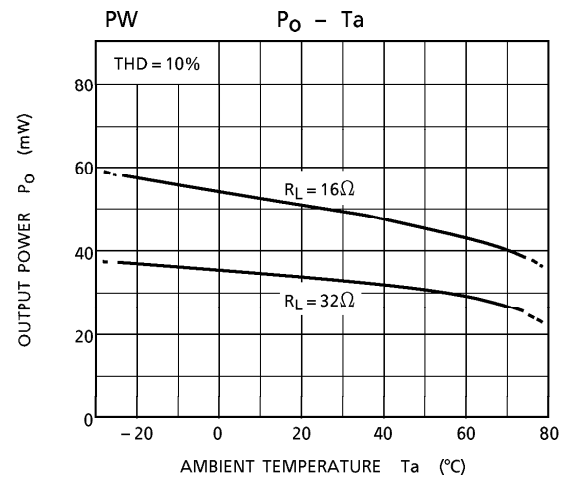
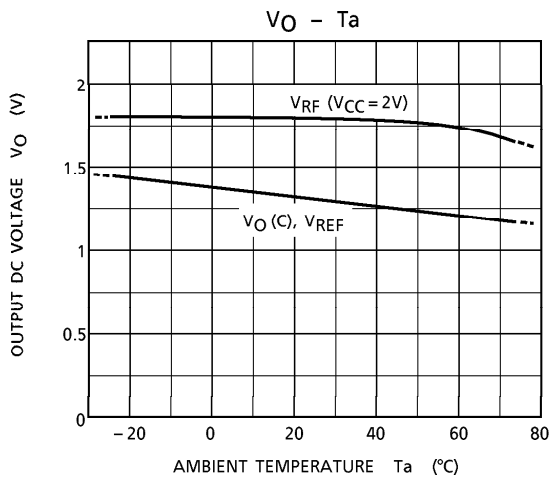
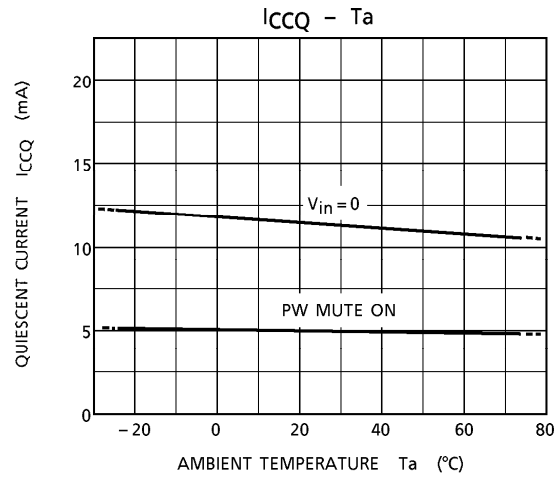
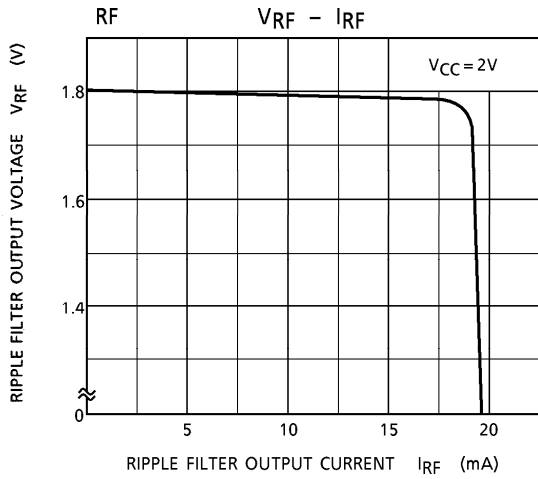
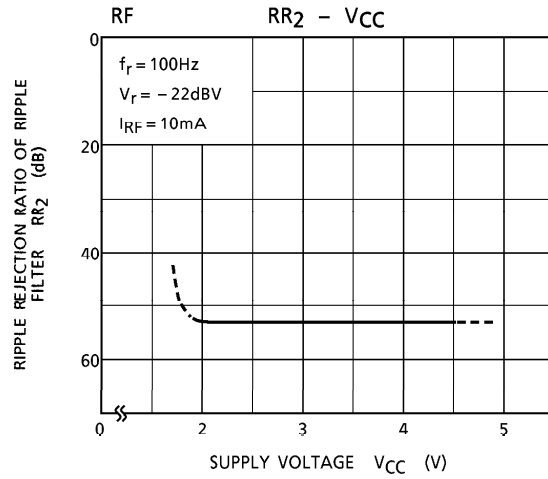
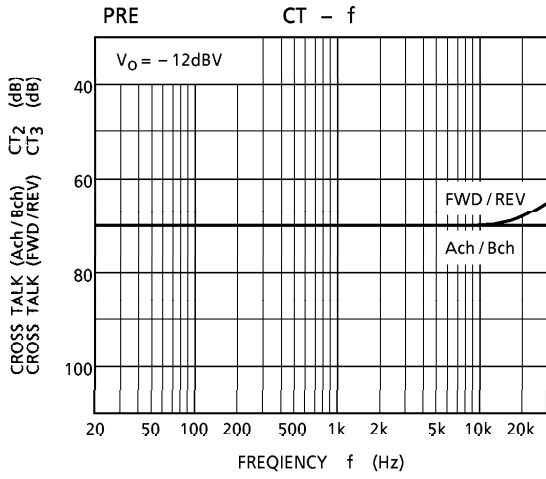

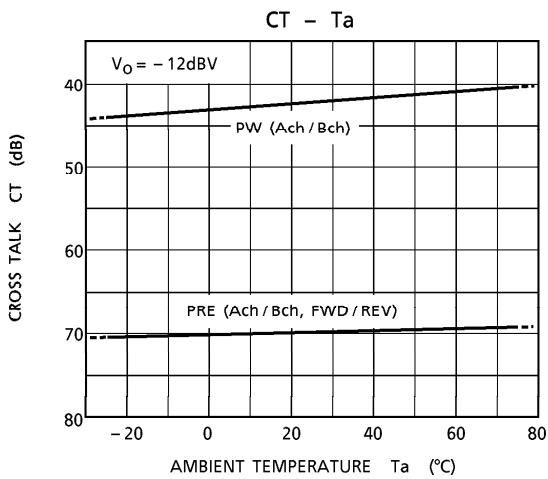
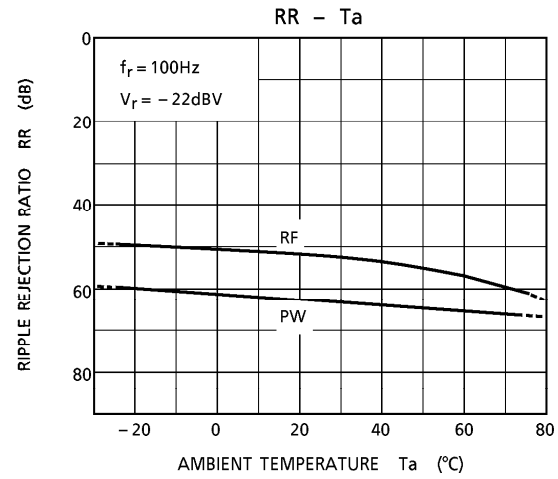
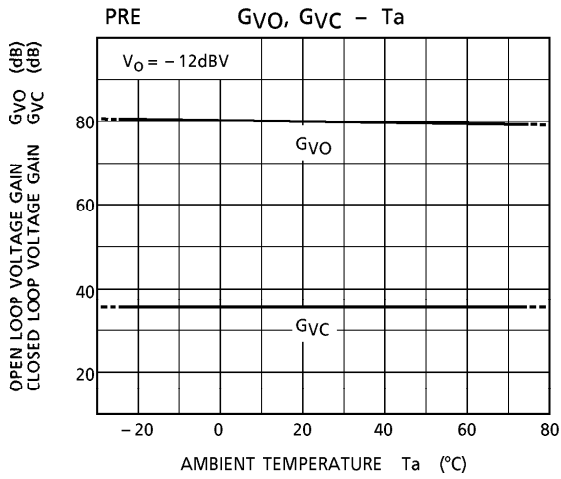
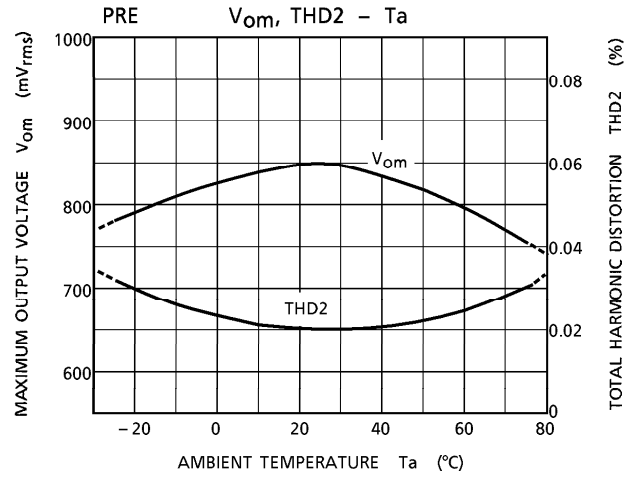
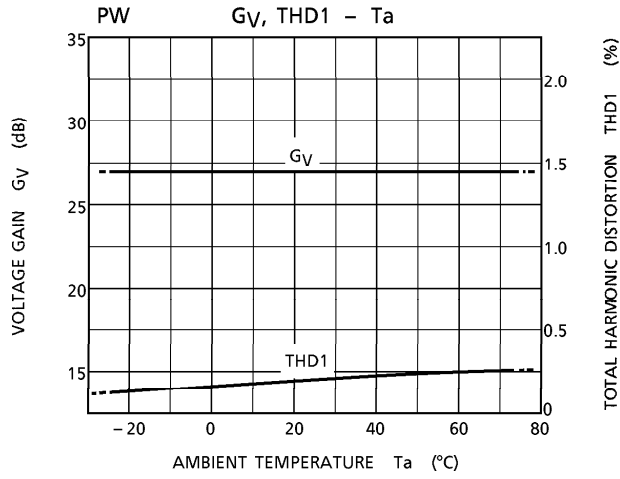

APPLICATION CIRCUIT

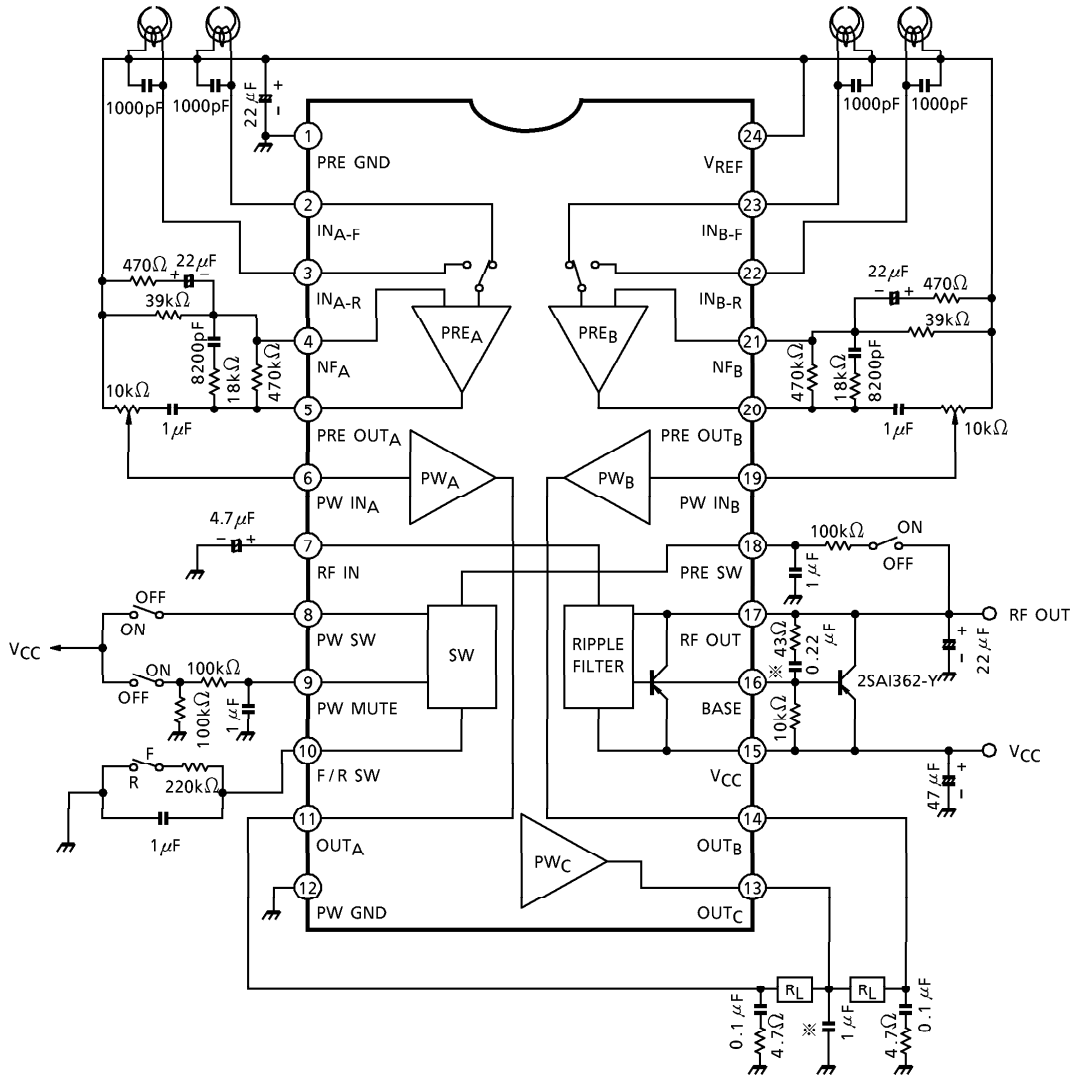

※ Monolithic ceramic condenser

OUTLINE DRAWING  
SSOP24-P-300-1.00

Unit : mm

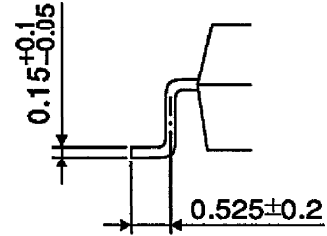
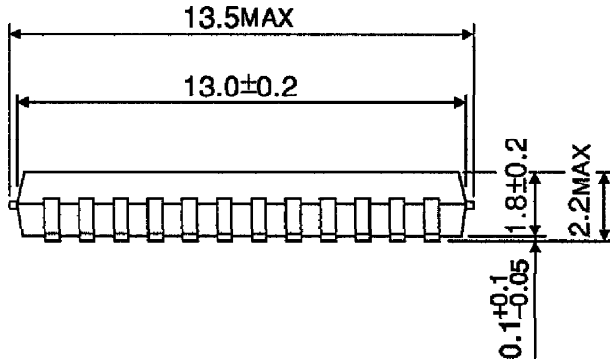
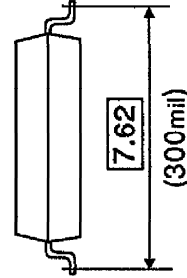
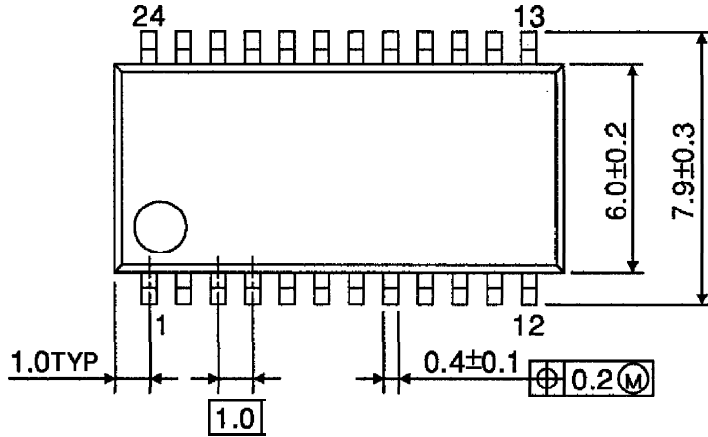

Weight : 0.32g (Typ.)



OUTLINE DRAWING

SSOP24-P-300-0.65A

Unit : mm

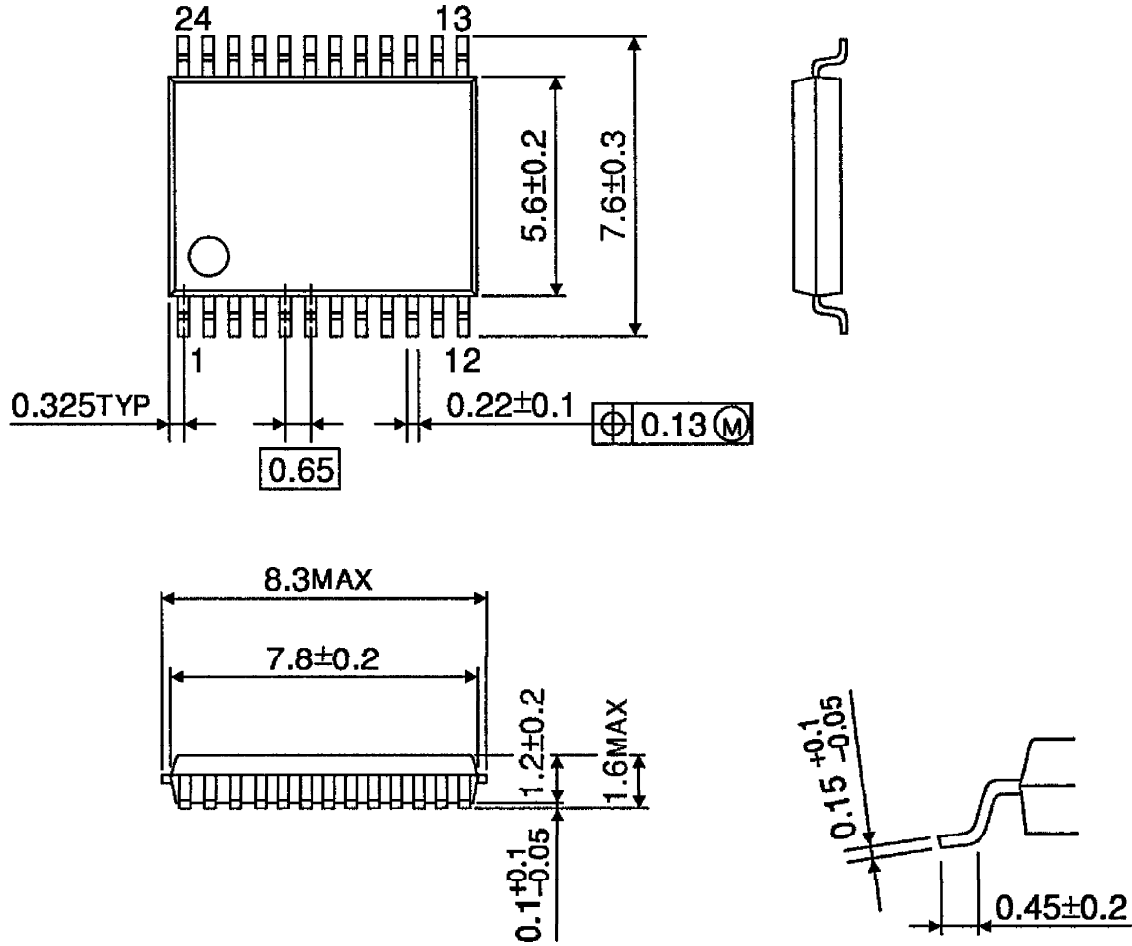

Weight : 0.14g (Typ.)