

TOSHIBA BIPOLAR LINEAR INTEGRATED CIRCUIT SILICON MONOLITHIC

TA2015FN

RIPPLE FILTER (1.5V USE)

The TA2015FN is a ripple filter IC, which is developed for low voltage operation (1.5V).

It is especially suitable for supplying voltage for headphone stereo etc.

FEATURES

- Built-in a power switch
- Excellent ripple rejection ratio : RR = 43dB (Typ.)
- Ripple filter output voltage can be controlled by external resistor.
- Output voltage is limited to $V_{RF} = 1.5V$ (Typ.)
- Built-in two constant current sources.
- Excellent low voltage operation.
- Low quiescent supply current ($V_{CC} = 1.2V, T_a = 25^\circ C$)
 $I_{CC} = 0.7mA$ (Typ.)
- Operating supply voltage range. ($T_a = 25^\circ C$)
 $V_{CC(opr)} = 0.9 \sim 2.2V$

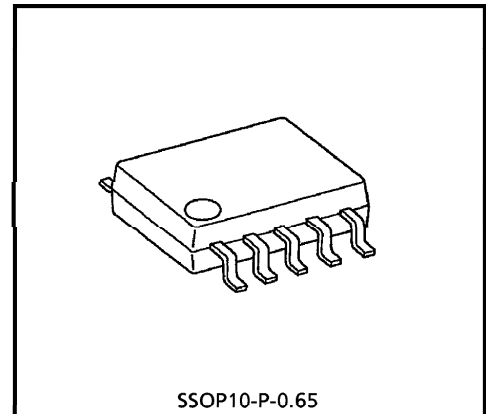

SSOP10-P-0.65
Weight : 0.04g (Typ.)

BLOCK DIAGRAM

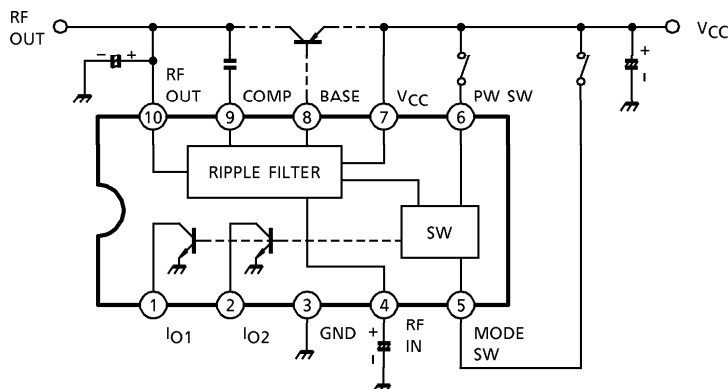

MARKING

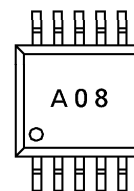

961001EBA2

● TOSHIBA is continually working to improve the quality and the reliability of its products. Nevertheless, semiconductor devices in general can malfunction or fail due to their inherent electrical sensitivity and vulnerability to physical stress. It is the responsibility of the buyer, when utilizing TOSHIBA products, to observe standards of safety, and to avoid situations in which a malfunction or failure of a TOSHIBA product could cause loss of human life, bodily injury or damage to property. In developing your designs, please ensure that TOSHIBA products are used within specified operating ranges as set forth in the most recent products specifications. Also, please keep in mind the precautions and conditions set forth in the TOSHIBA Semiconductor Reliability Handbook.

TERMINAL EXPLANATION

Terminal voltage : Typical terminal voltage with test circuit ($V_{CC} = 1.2V$, $T_a = 25^\circ C$, non Load)

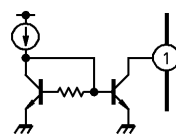
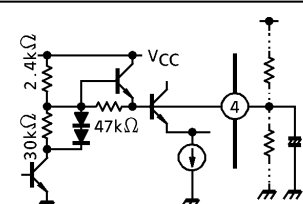
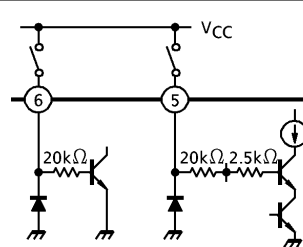
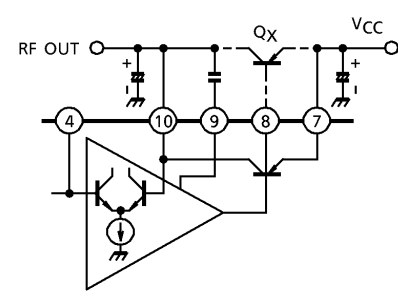
TERMINAL		FUNCTION	INTERNAL CIRCUIT	TERMINAL VOLTAGE (V)
No.	NAME			
1	I _{O1}	Output of constant current source 1 Operating condition (PW SW : H MODE SW : L		—
2	I _{O2}	Output of constant current source 2 Synchronized to PW SW		—
3	GND	—	—	0
4	RF IN	Ripple filter terminal Ripple filter output voltage can be controlled by external resistor. (See application note)		1.14
5	MODE SW	Mode switch (V _{CC} : I _{O2} , RF OUT on GND/OPEN : I _{O1} , I _{O2} on		—
6	PW SW	Power switch (V _{CC} : Power on GND/OPEN : Power off		—
7	V _{CC}	—	—	1.2
8	BASE	Base biasing terminal for ripple filter transistor. Output current capacity is 1.2mA with only built-in PNP transistor. This capacity can be increased with an external transistor Q _X .		0.5
9	COMP	Phase compensation terminal for a ripple filter circuit		0.5
10	RF OUT	Ripple filter output		1.14

961001EBA2'

- The products described in this document are subject to foreign exchange and foreign trade control laws.
- The information contained herein is presented only as a guide for the applications of our products. No responsibility is assumed by TOSHIBA CORPORATION for any infringements of intellectual property or other rights of the third parties which may result from its use. No license is granted by implication or otherwise under any intellectual property or other rights of TOSHIBA CORPORATION or others.
- The information contained herein is subject to change without notice.

APPLICATION NOTE

1. Operation mode of constant current source

Operation mode is decided by switch condition shown in table.1. Output of constant current source 1 can be used as a reset circuit by changing start up timing of PW SW, MODE SW.

	MODE SW	H	L
PW SW			
H		I _{O2} RF OUT	I _{O1} I _{O2}
L		—	—

Table.1 Operation mode

2. Ripple filter output

It is necessary to connect an external pull-down resistor with PW SW (pin⑥) and MODE SW (pin⑤) in case that ripple filter circuit doesn't operate normally due to external noise etc.

3. Adjustment of ripple filter output voltage

Internal circuit of pin④ is shown in Fig.1. Ripple filter output voltage is decided by internal resistor R₁, R₂ and Q₃, and limited by D_{1~2} and Q₃ to V_{RF} = 1.5V (Typ.)

Ripple filter output voltage can be controlled by method below.

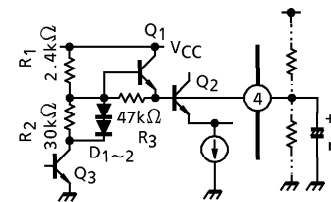

Fig.1 Internal circuit of pin④

(1) Method to rise the ripple filter output voltage

External resistor should be connected between V_{CC} and RF IN terminal (pin④). In this case, output current capacity of ripple filter circuit is down. Because at ripple filter output stage, collector-emitter voltage of PNP transistor will small, and drive capacity of transistor is down.

(2) Method to drop the ripple filter output voltage

External resistor should be connected between GND and RF IN terminal (pin④). Current flows through external resistor and internal resistor R₁, R₃ (2.4kΩ, 47kΩ). In case that output voltage dropped too much, ripple rejection ratio and other characteristics will be worse, because constant current source of differential amplifier is saturated especially at low voltage.

MAXIMUM RATINGS (Ta = 25°C)

CHARACTERISTIC	SYMBOL	RATING	UNIT
Supply Voltage	V _{CC}	4.5	V
Constant Current Source Output Voltage	V _S	4.5	
Constant Current Source Output Current	I _S	10	mA
Ripple Filter Output Current (Built-in transistor)	I _{RF}	20	
Power Dissipation	P _D (Note)	300	mW
Operating Temperature	T _{opr}	-25~75	°C
Storage Temperature	T _{stg}	-55~150	

(Note) Derated above Ta = 25°C in the proportion of 2.4mW/°C.

ELECTRICAL CHARACTERISTICS (Unless otherwise specified, V_{CC} = 1.2V, Ta = 25°C, SW₁ : ON, SW₂ : ON)

CHARACTERISTIC	SYMBOL	TEST CIRCUIT	TEST CONDITION	MIN.	TYP.	MAX.	UNIT	
Quiescent Supply Current	I _{CC1}	—	PW OFF, SW ₁ : OPEN SW ₂ : OPEN	—	0.1	5	μA	
	I _{CC2}	—	SW ₂ : OPEN, I _{O1} = I _{O2} = 0	—	0.5	0.8	mA	
	I _{CC3}	—	I _{RF} = I _{O2} = 0	—	0.7	1.0		
Ripple Filter Output Voltage	V _{RF}	—	V _{CC} = 1V, I _{RF} = 0	0.91	0.94	—	V	
Ripple Rejection Ratio	RR	—	V _r = -32dBV f _r = 100Hz, I _{RF} = 30mA	36	43	—	dB	
Constant Current Source Output Current	I _{O1}	—	SW ₂ : OPEN	50	—	—	μA	
	I _{O2}	—	—	50	—	—		
Power Switch On Current	I ₆	—	V _{CC} = 0.9V	V ₁₀ ≧ 0.6V	5	—	μA	
Power Switch Off Voltage	V ₆	—		V ₁₀ ≧ 0.3V	0	—	0.3	V
Mode Switch On Current	I ₅	—		V ₁₀ ≧ 0.6V	5	—	—	μA
Mode Switch Off Voltage	V ₅	—		V ₁₀ ≧ 0.3V	0	—	0.3	V

TEST CIRCUIT

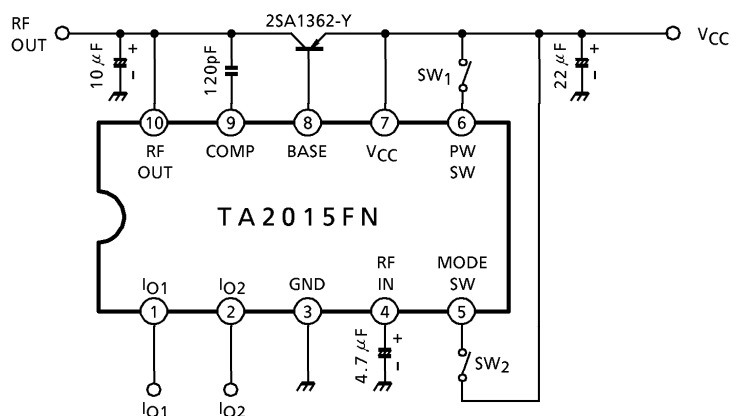

CHARACTERISTIC CURVES (Unless otherwise specified, $V_{CC} = 1.2V$, $I_{RF} = 0$, $I_{O1} = I_{O2} = 0$, $T_a = 25^\circ C$)

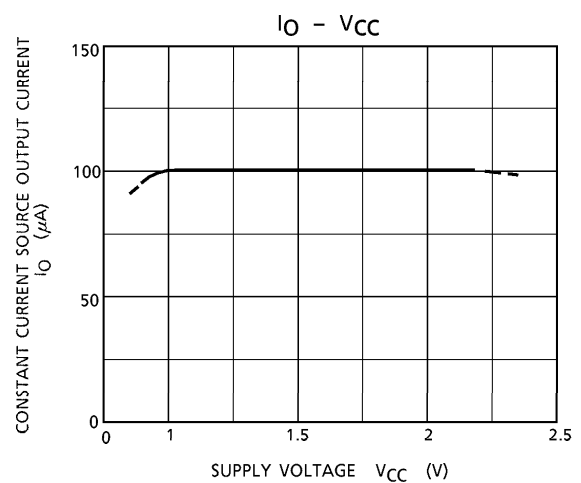
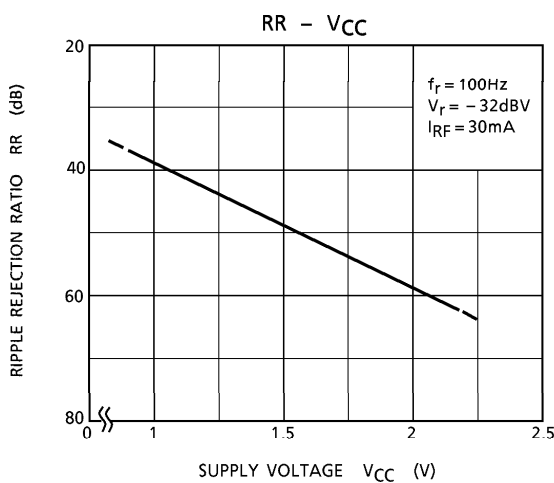
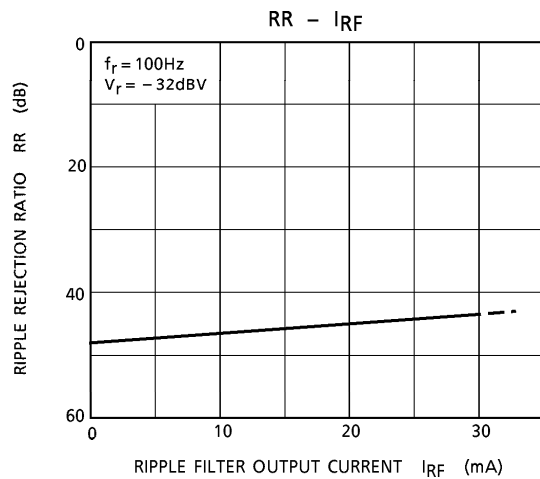
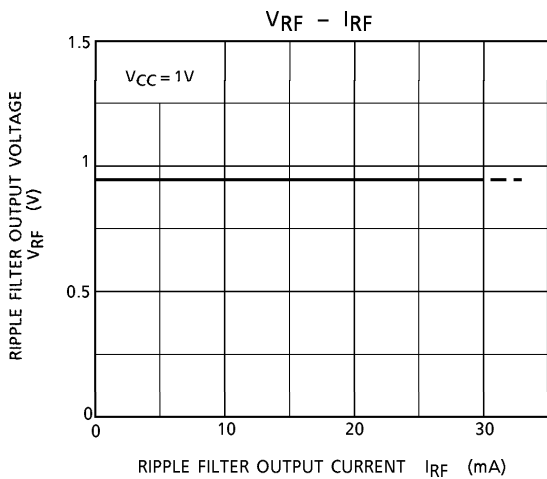
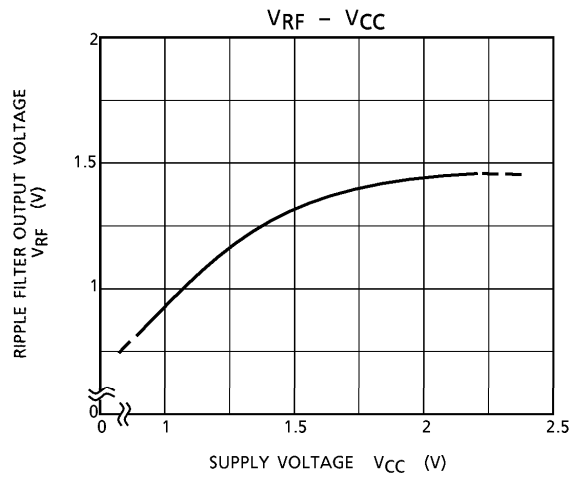
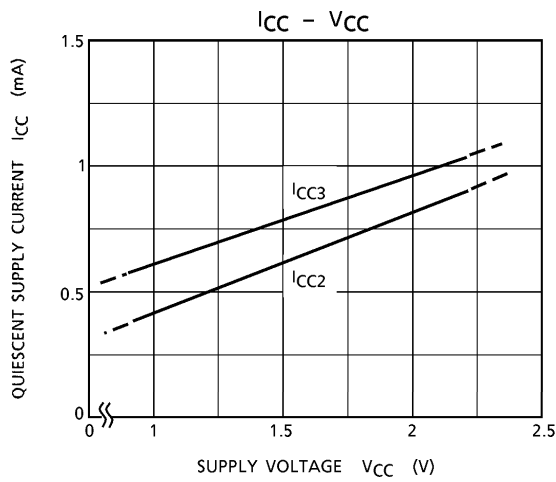

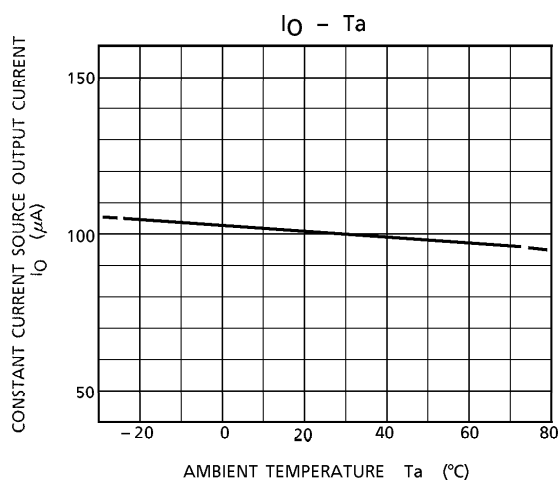
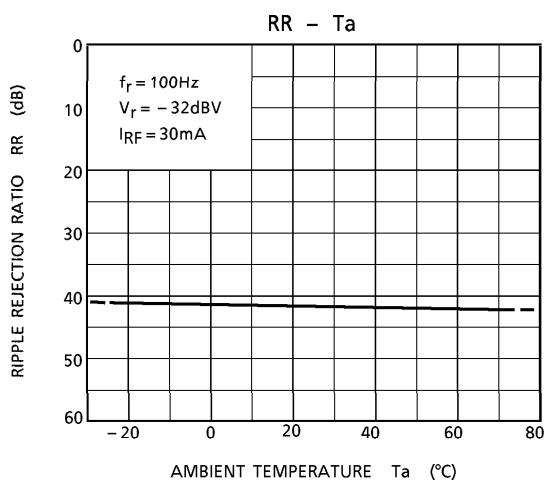
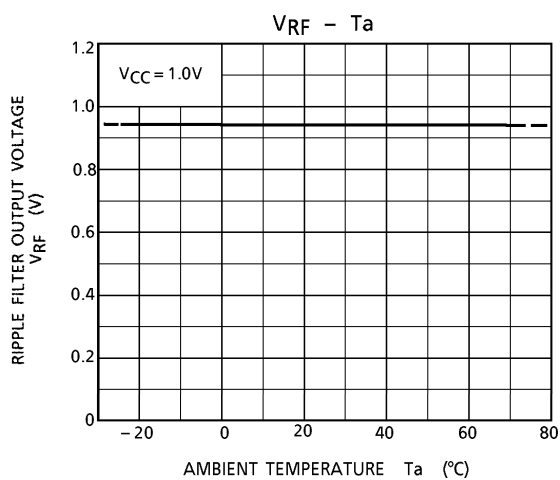
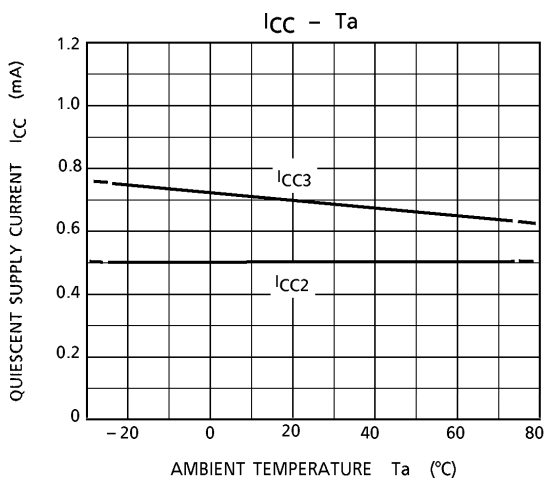

OUTLINE DRAWING
SSOP10-P-0.65

Unit : mm

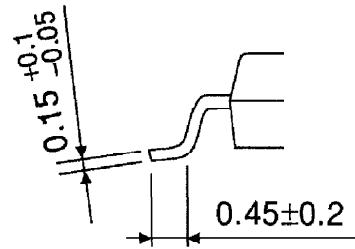
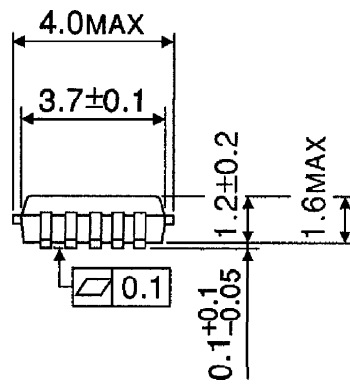
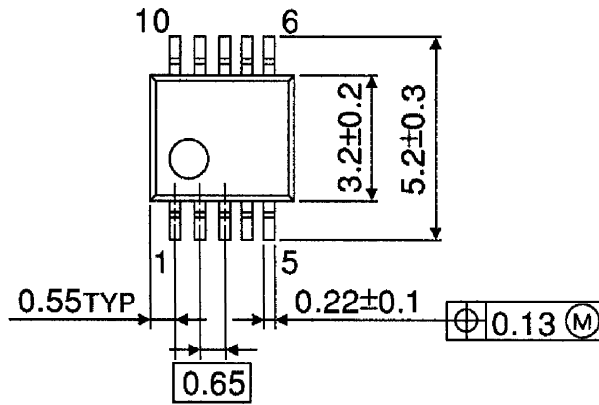

Weight : 0.04g (Typ.)