

TOSHIBA BIPOLAR LINEAR INTEGRATED CIRCUIT SILICON MONOLITHIC

TA8190F, TA8191F

CD FOCUS TRACKING SERVO LSI

The TA8190F, TA8191F is a 3-beam type PUH compatible focus tracking servo LSIs to be used in the CD player system.

In combination with a CMOS single chip processor TC9236AF, a CD player system can be composed very simply.

FEATURES

- Built-in RF amp, focus error amp, and tracking error amp.
 - Built-in focus tracking servo amp.
 - Built-in phase compensation amp and LPF amp. (Regarding these amp, the pin connection differs between the TA8190F and the TA8191F.)
 - Built-in ALPC amp.
 - Connections between PUH and power driver IC for motor driver allow simplified structuring of CD player system.
- TA8190F : Directly connectable to a transistor push-pull or power driver (TA8212F).

TA8191F : Directly connectable to BTL amp (TA8192F) or PWM driver (TA8460F).

- Differences between TA8190F and TA8191F are as follows :

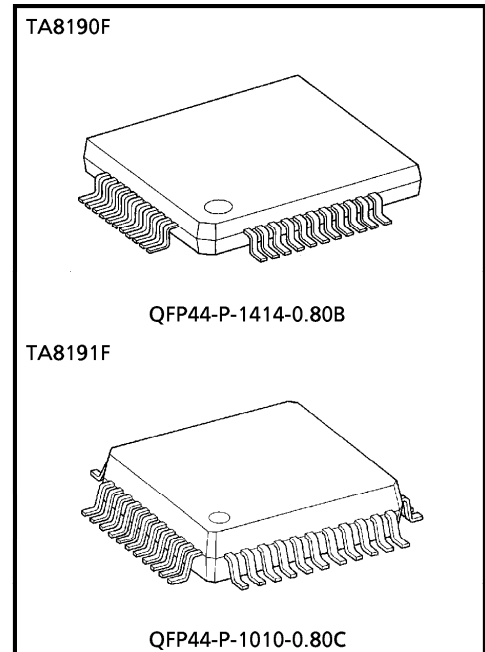

Weight
 QFP44-P-1414-0.80B : 1.15g (Typ.)
 QFP44-P-1010-0.80C : 0.5g (Typ.)

MODEL	REFERENCE VOLTAGE TERMINAL		PACKAGE (FLAT PACKAGE 44 PIN)	POWER SUPPLY	APPLICATION
	V _{REF}	2V _{REF}			
TA8190F	Yes	No	QFP44-P-1414B	± 5V double power supply	CD player
TA8191F	Yes	Yes	QFP44-P-1010C	+ 5V single power supply	Portable CD player Radio-cassette CD player

(V_{REF} = 2.1V, 2V_{REF} = 4.2V)

980508EBA2

● TOSHIBA is continually working to improve the quality and the reliability of its products. Nevertheless, semiconductor devices in general can malfunction or fail due to their inherent electrical sensitivity and vulnerability to physical stress. It is the responsibility of the buyer, when utilizing TOSHIBA products, to observe standards of safety, and to avoid situations in which a malfunction or failure of a TOSHIBA product could cause loss of human life, bodily injury or damage to property. In developing your designs, please ensure that TOSHIBA products are used within specified operating ranges as set forth in the most recent products specifications. Also, please keep in mind the precautions and conditions set forth in the TOSHIBA Semiconductor Reliability Handbook.

BLOCK DIAGRAM
TA8191F

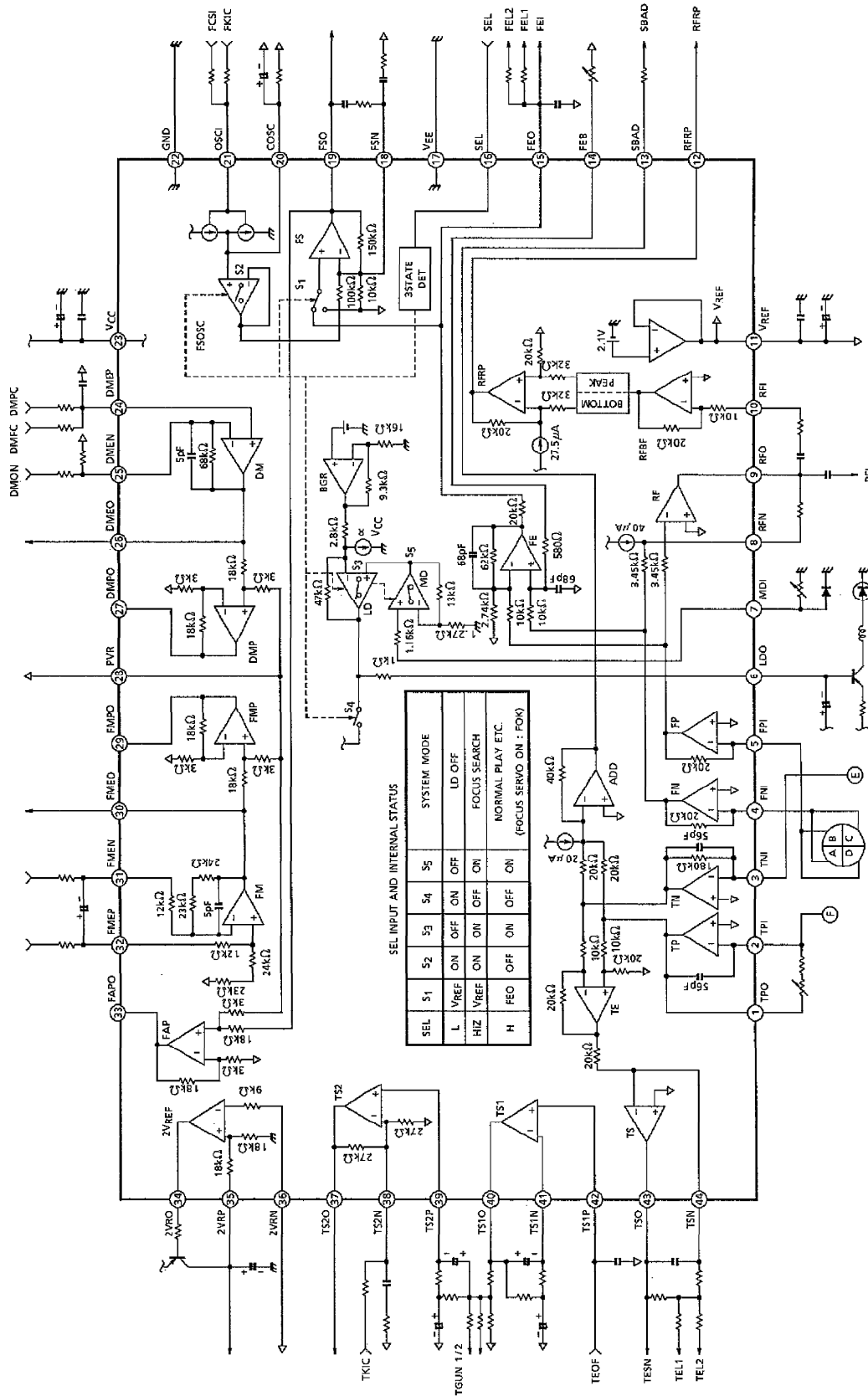

TA8190F,91F - 3

PIN FUNCTION
(Common)

PIN No.	SYMBOL	I/O	FUNCTIONAL DESCRIPTION	REMARKS
1	TPO	O	Sub-beam I-V amp (TP AMP) output terminal.	Connected to TPI through adjusting feedback resistor.
2	TPI	I	Sub-beam I-V amp (TP AMP) input terminal.	Connected to PIN diode F.
3	TNI	I	Sub-beam I-V amp (TN AMP) input terminal.	Connected to PIN diode E.
4	FNI	I	Main-beam I-V amp (FN AMP) input terminal.	Connected to PIN diode A + C.
5	FPI	I	Main-beam I-V amp (FP AMP) input terminal.	Connected to PIN diode B + D.
6	LDO	O	Laser diode amp (LD AMP) input terminal.	Connected to laser diode circuit.
7	MDI	I	Monitor photo diode amp (MD AMP) input terminal.	Connected to monitor photo diode.
8	RFN	I	RF amp (RF AMP) negative phase input terminal.	Connected to RFO through feedback resistor.
9	RFO	O	RF amp (RF AMP) output terminal.	—
10	RFI	I	RF ripple signal generating circuit input terminal.	Connected to RFO through CR.
11	VREF	O	Reference voltage supply output terminal. (+2.1V)	—
12	RFRP	O	RF ripple signal output terminal.	—
13	SBAD	O	Defects detection signal output terminal.	—
14	FEB	I	Focus error balance adjusting input terminal.	Adjusting semi-fixed resistor connected.
15	FEO	O	Focus error amp (FE AMP) output terminal.	Gain adjusting resistor is connected.
16	SEL	I	Analog switch control signal input terminal.	—
17	VEE	—	Power source terminal. (TA8190F : -5V, TA8191F : GND)	—
18	FSN	I	Focus output amp (FS AMP) negative phase input terminal.	Connected to FSO through feedback CR.
19	FSO	O	Focus output amp (FS AMP) output terminal.	—
20	COSC	O	Focus search signal generating capacitor connecting terminal.	CR is connected.
21	OSCI	I	Focus search signal generating built-in current source control input terminal.	—
22	GND	—	Ground terminal.	—

(Common)

PIN No.	SYMBOL	I/O	FUNCTIONAL DESCRIPTION	REMARKS
23	VCC	—	Power source terminal. (+5V)	—
24	DMEP	I	Disc motor amp (DM AMP) positive phase input terminal.	—
25	DMEN	I	Disc motor amp (DM AMP) negative phase input terminal.	—
31	FMEN	I	Feed motor amp (FM AMP) negative phase input terminal.	—
32	FMEP	I	Feed motor amp (FM AMP) positive phase input terminal.	—
37	TS2O	O	Tracking servo amp 2 (TS2 AMP) output terminal.	—
38	TS2N	I	Tracking servo amp 2 (TS2 AMP) negative phase input terminal.	—
39	TS2P	I	Tracking servo amp 2 (TS2 AMP) positive phase input terminal.	—
40	TS1O	O	Tracking servo amp 1 (TS1 AMP) output terminal.	—
41	TS1N	I	Tracking servo amp 1 (TS1 AMP) negative phase input terminal.	Connected to TS1O through feedback CR.
42	TS1P	I	Tracking servo amp 1 (TS1 AMP) positive phase input terminal.	—
43	TSO	O	Tracking output amp (TS AMP) output terminal.	—
44	TSN	I	Tracking output amp (TS AMP) negative phase input terminal.	Connected to TSO through feedback CR.

(TA8190F)

PIN No.	SYMBOL	I/O	FUNCTIONAL DESCRIPTION	REMARKS
26	PVR	I	Driving amp reference voltage input terminal.	Connect to GND.
27	DMPN	I	Disc motor driving amp (DMP AMP) negative phase input terminal.	—
28	DMPO	O	Disc motor driving amp (DMP AMP) output terminal.	Connected to DMPN through external output Tr.
29	FMPO	O	Feed motor driving amp (FMP AMP) output terminal.	Connected to EMPN through external output Tr.
30	FMPN	I	Feed motor driving amp (FMP AMP) negative phase input terminal.	—
33	FAPN	I	Focus actuator driving amp (FAP AMP) negative phase input terminal.	—
34	FAPO	O	Focus actuator driving amp (FAP AMP) output terminal.	Connected to FAPN through external output Tr.
35	TAPO	O	Tracking actuator driving amp (TAP AMP) output terminal.	Connected to TAPN through external output Tr.
36	TAPN	I	Tracking actuator driving amp (TAP AMP) negative phase input terminal.	—

(TA8191F)

PIN No.	SYMBOL	I/O	FUNCTIONAL DESCRIPTION	REMARKS
26	DME0	O	Disc motor amp (DM AMP) output terminal.	—
27	DMPO	O	Disc motor driving amp (DM AMP) output terminal.	—
28	PVR	I	Driving amp reference voltage input terminal.	Connected to VREF.
29	FMPO	O	Feed motor driving amp (FMP AMP) output terminal.	—
30	FME0	O	Feed motor amp (FM AMP) output terminal.	—
33	FAPO	O	Focus actuator driving amp (FAP AMP) output terminal.	—
34	2VRO	O	2VREF amp (2VREF AMP) output terminal.	Connected to 2VRP through external output Tr.
35	2VRP	I	2VREF amp (2VREF AMP) positive phase input terminal.	—
36	2VRN	I	2VREF amp (2VREF AMP) negative phase input terminal.	—

MAXIMUM RATINGS (Ta = 25°C)

CHARACTERISTIC		SYMBOL	RATING	UNIT
Power Supply Voltage		V _{CC} -V _{EE}	0.3~12.0	V
Power Dissipation	TA8190F	P _D	960 (*1)	mW
	TA8191F		780 (*2)	
Operating Temperature		T _{opr}	-25~75	°C
Storage Temperature		T _{stg}	-55~150	°C

(*1) Derated above 25°C in the proportion of 7.7mW/°C.

(*2) Derated above 25°C in the proportion of 6.2mW/°C.

ELECTRICAL CHARACTERISTICS

(Unless otherwise specified, TA8190F : V_{CC} = 5V, V_{EE} = -5V, Ta = 25°C
 TA8191F : V_{CC} = 5V, V_{EE} = GND, Ta = 25°C)

CHARACTERISTIC		SYMBOL	TEST CIR-CUIT	TEST CONDITION	MIN.	TYP.	MAX.	UNIT
Power Source (TA8190F)	Power Supply Voltage	V _{CC}	—	Ta = -25~75°C	4.5	5.0	5.5	V
		V _{EE}	—		-5.5	-5.0	-4.5	
	Power Supply Current	I _{CC}	1	SEL = HiZ	14.0	24.0	32.0	mA
		I _{EE}	1	—	3.0	5.0	7.0	
Power Source (TA8191F)	Power Supply Voltage	V _{CC}	—	Ta = -25~75°C	4.5	5.0	5.5	V
	Power Supply Current	I _{CC}	3	—	14.0	24.0	32.0	mA
Reference Power Supply V _{REF} (Common)	Reference Voltage	V _{REF}	1, 3	—	1.95	2.10	2.25	V
	Reference Voltage Temperature Characteristic	ΔV/ΔT	1, 3	—	-3.0	-2.0	-1.0	mV/°C
	Output Current	I _{OH}	1, 3	—	5.0	—	—	mA
	Input Current	I _{OL}	1, 3	—	5.0	—	—	mA
FI ↓ RFO (Common)	Permissible Input Current	I _{IM}	1, 3	per each ch	30	—	—	μA
	Transfer Resistance	R _T	1, 3	f = 100kHz	115	127	140	kΩ
	Frequency Characteristic	f _c	2, 4	-3dB point	3.0	—	—	MHz
	Output Signal Slew Rate	SR	2, 4	C _{RFO} = 20pF	10	20	—	V/μs
	Total Harmonic Distortion	THD	1, 3	f = 100kHz V _{REO} = 1.27V _{p-p}	—	-40	-30	dB

CHARACTERISTIC		SYMBOL	TEST CIR-CUIT	TEST CONDITION	MIN.	TYP.	MAX.	UNIT
FI ↓ RFO (Common)	Operation Reference Voltage	V _{OPR}	1, 3	V _{REF} reference	-1.13	-0.88	-0.72	V
	Upper Limit Output Voltage	V _{OH}	1, 3	V _{REF} reference	1.4	—	—	V
	Lower Limit Output Voltage	V _{OL}	1, 3	V _{REF} reference	—	—	-1.4	V
	Permissive Load Resistance	R _{LM}	—	—	10	—	—	kΩ
RFI ↓ RFRP (Common)	Input Operating Voltage	V _I	1, 3	—	0.8	—	1.6	V _{p-p}
	Voltage Gain	G _V	1, 3	f = 1kHz	0.55	0.62	0.69	V/V
	Peak Hold Frequency Characteristic	f _{CPD}	1, 3	—	60	120	240	kHz
	Bottom Hold Frequency Characteristics	f _{CBD}	1, 3	—	60	120	240	kHz
	Operation Reference Voltage 1	V _{OPR}	1, 3	V _{REF} reference	-0.61	-0.55	-0.49	V
	Operation Reference Voltage 2	V _{OPR}	1, 3	V _{REF} reference 700kHz, 1V _{p-p} input	-120	0	120	mV
	Permissive Load Resistance	R _{LM}	—	—	10	—	—	kΩ
FI ↓ FEO (Common)	Transfer Resistance	R _T	1, 3	f = 1kHz	97	124	151	kΩ
	Gain Balance	GB	1, 3	f = 1kHz	-1.5	—	1.5	dB
	Frequency Characteristic	f _c	1, 3	-3dB point	20	30	60	kHz
	Total Harmonic Distortion	THD	1, 3	f = 1kHz V _{FEO} = 1.7V _{p-p}	—	—	-40	dB
	Output Offset Voltage	V _{OS}	1, 3	V _{REF} reference	-100	—	100	mV
	Offset Voltage Drift	ΔV/ΔT	1, 3	—	-400	—	400	μV/°C
	Upper Limit Output Voltage	V _{OH}	1, 3	V _{REF} reference	1.5	—	—	V
	Lower Limit Output Voltage	V _{OL}	1, 3	V _{REF} reference	—	—	-1.5	V

CHARACTERISTIC		SYMBOL	TEST CIR-CUIT	TEST CONDITION	MIN.	TYP.	MAX.	UNIT
TI ↓ TSO (Common)	Permissive Input Current	I _{IM}	1, 3	Per each ch	5.0	—	—	μA
	Transfer Resistance	R _T	1, 3	f = 1kHz	354	432	554	kΩ
	Gain Balance	GB	1, 3	f = 1kHz	-2.0	—	2.0	dB
	Frequency Characteristic	f _c	1, 3	-3dB point	10	16	30	kHz
	Total Harmonic Distortion	THD	1, 3	f = 1kHz V _{TSO} = 0.8V _{p-p}	—	—	-40	dB
	Output Offset Voltage	V _{OS}	1, 3	V _{REF} reference	-50	—	50	mV
	Offset Voltage Drift	ΔV/ΔT	1, 3	—	-200	—	200	μV/°C
	Upper Limit Output Voltage	V _{OH}	1, 3	V _{REF} reference	1.5	—	—	V
	Lower Limit Output Voltage	V _{OL}	1, 3	V _{REF} reference	—	—	-1.5	V
	Permissive Load Resistance	R _{LM}	—	—	10	—	—	kΩ
TI ↓ SBAD (Common)	Permissive Input Current	I _{IM}	1, 3	Total in both ch	7.0	—	—	μA
	Transfer Resistance	R _T	1, 3	f = 1kHz	280	360	440	kΩ
	Frequency Characteristic	f _c	1, 3	-3dB point	10	16	30	kHz
	Total Harmonic Distortion	THD	1, 3	f = 1kHz V _{SBAD} = 1.6V _{p-p}	—	—	-40	dB
	Operation Reference Voltage	V _{OPR}	1, 3	V _{REF} reference	-0.88	-0.80	-0.72	V
	Upper Limit Output Voltage	V _{OH}	1, 3	V _{REF} reference	1.5	—	—	V
	Lower Limit Output Voltage	V _{OL}	1, 3	V _{REF} reference	—	—	-1.5	V
	Permissive Load Resistance	R _{LM}	—	—	10	—	—	kΩ
OSCI ↓ FSO (Common)	Output Amplitude	V _O	—	f _{OSCI} = 0.5Hz (CMOS level)	610	700	780	mV _{p-p}
	Output Offset Voltage	V _{OS}	—	OSCI : HiZ	-35	—	35	mV
	Output Switch Isolation	V _{ISO}	—	f _{OSCI} = 0.5Hz SEL : "H" level	—	—	25	mV _{p-p}

CHARACTERISTIC		SYMBOL	TEST CIR-CUIT	TEST CONDITION	MIN.	TYP.	MAX.	UNIT
FEO ↓ FSO (TA8190F)	Voltage Gain 1	G _{V1}	—	f = 10kHz V _{FSO} = 1V _{p-p}	14.5	16.0	17.5	V/V
	Voltage Gain 2	G _{V2}	—	R _{NF} (FSO-FSN) : 12kΩ	1.79	2.11	2.43	V/V
	Upper Limit Output Voltage	V _{OH}	—	GND reference	3.6	—	—	V
	Lower Limit Output Voltage	V _{OL}	—	GND reference	—	—	0.5	V
	Output Offset Voltage	V _{OS}	—	—	- 32	—	32	mV
	Total Harmonic Distortion	THD	—	f = 10kHz V _{FSO} = 1V _{p-p}	—	—	- 40	dB
FEO ↓ FSO (TA8191F)	Voltage Gain 1	G _{V1}	—	f = 10kHz V _{FSO} = 1V _{p-p}	14.5	16.0	17.5	V/V
	Voltage Gain 2	G _{V2}	—	R _{NF} (FSO-FSN) : 12kΩ	1.79	2.11	2.43	V/V
	Upper Limit Output Voltage	V _{OH}	—	GND reference	3.6	—	—	V
	Lower Limit Output Voltage	V _{OL}	—	GND reference	—	—	0.5	V
	Output Offset Voltage	V _{OS}	—	—	- 32	—	32	mV
	Total Harmonic Distortion	THD	—	f = 10kHz V _{FSO} = 1V _{p-p}	—	—	- 40	dB
FEO ↓ FAPO (TA8190F)	Voltage Gain	G _V	—	f = 10kHz V _{FAPO} = 1V _{p-p}	80	96	114	V/V
	Upper Limit Output Voltage	V _{OH}	—	GND reference	2.8	—	—	V
	Lower Limit Output Voltage	V _{OL}	—	GND reference	—	—	- 2.8	V
	Output Offset Voltage	V _{OS}	—	—	- 200	—	200	mV
	Total Harmonic Distortion	THD	—	f = 10kHz V _{FAPO} = 1V _{p-p} R _L = 8Ω	—	—	- 40	dB

CHARACTERISTIC		SYMBOL	TEST CIRCUIT	TEST CONDITION	MIN.	TYP.	MAX.	UNIT
FEO ↓ FAPO (TA8191F)	Voltage Gain	G _V	—	f = 10kHz V _{FAPO} = 1V _{p-p}	14.0	16.0	18.0	V/V
	Upper Limit Output Voltage	V _{OH}	—	GND reference	3.6	—	—	V
	Lower Limit Output Voltage	V _{OL}	—	GND reference	—	—	1.0	V
	Output Offset Voltage	V _{OS}	—	—	-40	—	40	mV
	Total Harmonic Distortion	THD	—	f = 10kHz V _{FAPO} = 1V _{p-p}	—	—	-40	dB
TS1P ↓ TS1O (Common)	Voltage Gain	G _V	—	f = 10kHz V _{TS1O} = 1V _{p-p}	0.95	1.00	1.05	V/V
	Upper Limit Output Voltage	V _{OH}	—	GND reference	3.6	—	—	V
	Lower Limit Output Voltage	V _{OL}	—	GND reference	—	—	1.0	V
	Output Offset Voltage	V _{OS}	—	—	-5.0	—	5.0	mV
	Input Bias Current	I _I	—	—	-100	—	100	nA
	Total Harmonic Distortion	THD	—	f = 10kHz V _{TS1O} = 1V _{p-p}	—	—	-40	dB
TS2P ↓ TS2O (Common)	Voltage Gain	G _V	—	f = 10kHz V _{TS2O} = 1V _{p-p}	1.9	2.0	2.1	V/V
	Upper Limit Output Voltage	V _{OH}	—	GND reference	3.6	—	—	V
	Lower Limit Output Voltage	V _{OL}	—	GND reference	—	—	0.5	V
	Output Offset Voltage	V _{OS}	—	—	-10	—	10	mV
	Input Bias Current	I _I	—	—	-100	—	100	nA
	Total Harmonic Distortion	THD	—	f = 10kHz V _{TS2O} = 1V _{p-p}	—	—	-40	dB

CHARACTERISTIC		SYMBOL	TEST CIRCUIT	TEST CONDITION	MIN.	TYP.	MAX.	UNIT
TS2P ↓ TAPO (TA8190F)	Voltage Gain	G _V	—	f = 10kHz V _{TAPO} = 1V _{p-p}	10.5	12.0	13.5	V/V
	Upper Limit Output Voltage	V _{OH}	—	GND reference	2.8	—	—	V
	Lower Limit Output Voltage	V _{OL}	—	GND reference	—	—	-2.8	V
	Output Offset Voltage	V _{OS}	—	—	-80	—	80	mV
	Total Harmonic Distortion	THD	—	f = 10kHz V _{TAPO} = 1V _{p-p} R _L = 8Ω	—	—	-40	dB
DMEP ↓ DME0 (TA8191F)	Voltage Gain	G _V	—	f = 10kHz V _{DME0} = 1V _{p-p}	5.7	6.7	7.7	V/V
	Upper Limit Output Voltage	V _{OH}	—	GND reference	3.6	—	—	V
	Lower Limit Output Voltage	V _{OL}	—	GND reference	—	—	0.5	V
	Output Offset Voltage	V _{OS}	—	—	-15	—	15	mV
	Total Harmonic Distortion	THD	—	f = 10kHz V _{DME0} = 1V _{p-p}	—	—	-40	dB
DMEP ↓ DMPO (TA8190F)	Voltage Gain	G _V	—	f = 10kHz V _{DMPO} = 1V _{p-p}	32	40	50	V/V
	Upper Limit Output Voltage	V _{OH}	—	GND reference	2.8	—	—	V
	Lower Limit Output Voltage	V _{OL}	—	GND reference	—	—	-2.8	V
	Output Offset Voltage	V _{OS}	—	—	-100	—	100	mV
	Total Harmonic Distortion	THD	—	f = 10kHz V _{DMPO} = 1V _{p-p} R _L = 8Ω	—	—	-35	dB

CHARACTERISTIC		SYMBOL	TEST CIRCUIT	TEST CONDITION	MIN.	TYP.	MAX.	UNIT
DMEP ↓ DMPO (TA8191F)	Voltage Gain	G _V	—	f = 10kHz V _{DMPO} = 1V _{p-p}	5.4	6.7	8.0	V/V
	Upper Limit Output Voltage	V _{OH}	—	GND reference	3.6	—	—	V
	Lower Limit Output Voltage	V _{OL}	—	GND reference	—	—	1.2	V
	Output Offset Voltage	V _{OS}	—	—	-30	—	30	mV
	Total Harmonic Distortion	THD	—	f = 10kHz V _{DMPO} = 1V _{p-p}	—	—	-40	dB
FMPEP ↓ FMPEO (TA8191F)	Voltage Gain	G _V	—	f = 10kHz V _{FMEO} = 1V _{p-p} V _{FMEN} = V _{REF}	3.6	3.9	4.3	V/V
	Upper Limit Output Voltage	V _{OH}	—	GND reference	3.6	—	—	V
	Lower Limit Output Voltage	V _{OL}	—	GND reference	—	—	0.5	V
	Output Offset Voltage	V _{OS}	—	—	-15	—	15	mV
	Total Harmonic Distortion	THD	—	f = 10kHz V _{FMEO} = 1V _{p-p}	—	—	-40	dB
FMPEP ↓ FMPEO (TA8190F)	Voltage Gain	G _V	—	f = 10kHz V _{FMPEO} = 1V _{p-p}	124	150	177	V/V
	Upper Limit Output Voltage	V _{OH}	—	GND reference	2.8	—	—	V
	Lower Limit Output Voltage	V _{OL}	—	GND reference	—	—	-2.8	V
	Output Offset Voltage	V _{OS}	—	—	-500	—	500	mV
	Total Harmonic Distortion	THD	—	f = 10kHz V _{FMPEO} = 1V _{p-p} R _L = 8Ω	—	—	-30	dB

CHARACTERISTIC		SYMBOL	TEST CIRCUIT	TEST CONDITION	MIN.	TYP.	MAX.	UNIT
FMEP ↓ FMPO (TA8191F)	Voltage Gain	G_V	—	$f = 10\text{kHz}$ $V_{FMPO} = 1V_{p-p}$ $V_{FMEN} = V_{REF}$	3.4	3.9	4.6	V/V
	Upper Limit Output Voltage	V_{OH}	—	GND reference	3.6	—	—	V
	Lower Limit Output Voltage	V_{OL}	—	GND reference	—	—	1.0	V
	Output Offset Voltage	V_{OS}	—	—	-20	—	20	mV
	Total Harmonic Distortion	THD	—	$f = 10\text{kHz}$ $V_{FMPO} = 1V_{p-p}$	—	—	-40	dB
2VRN ↓ 2VR (TA8191F)	DC Voltage Gain	G_{VDC}	—	$V_{2VR} = V_{REF}$	1.90	2.00	2.10	V/V
MDI ↓ LDO (Common)	Reference Operating Voltage	V_{MDI}	—	V_{MDI} at which V_{LDO} becomes 3.5V.	170	178	192	mV
	Voltage Gain	G_V	—	$f = 10\text{kHz}$ $V_{LDO} = 0.5V_{p-p}$	170	200	230	mV
	Input Bias Current	I_I	—	—	-200	—	200	nA
	Ripple Removing Ratio (With V_{CC})	RR	—	Input converted value	—	—	-56	dB
	Frequency Characteristic	f_c	—	-3dB point	20	—	—	kHz
	LD Off Voltage (With V_{CC})	$V_{LD\ OFF}$	—	SEL = L	-0.7	—	—	V

TEST CIRCUIT 4

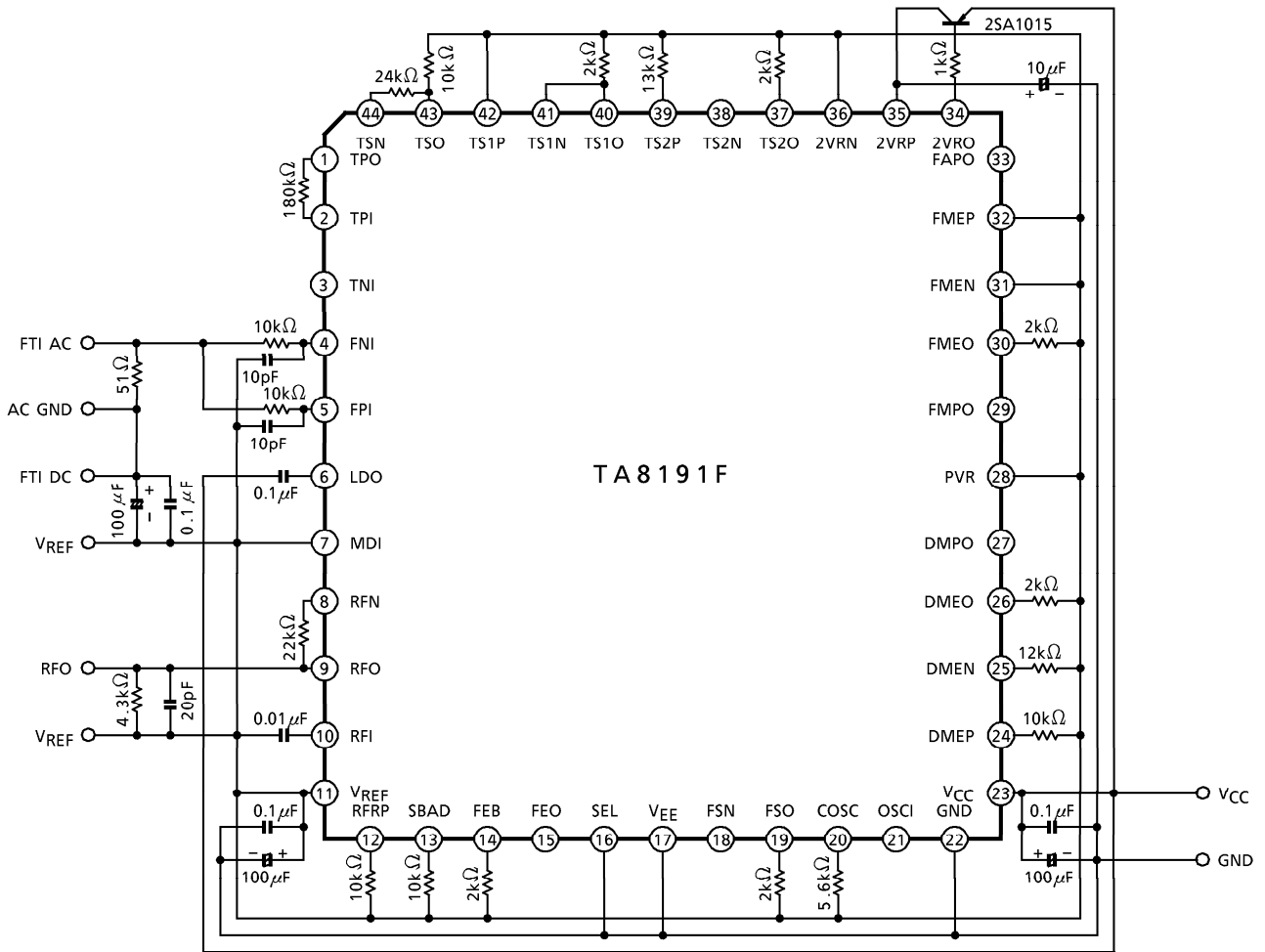

OUTLINE DRAWING
QFP44-P-1414-0.80B

Unit : mm

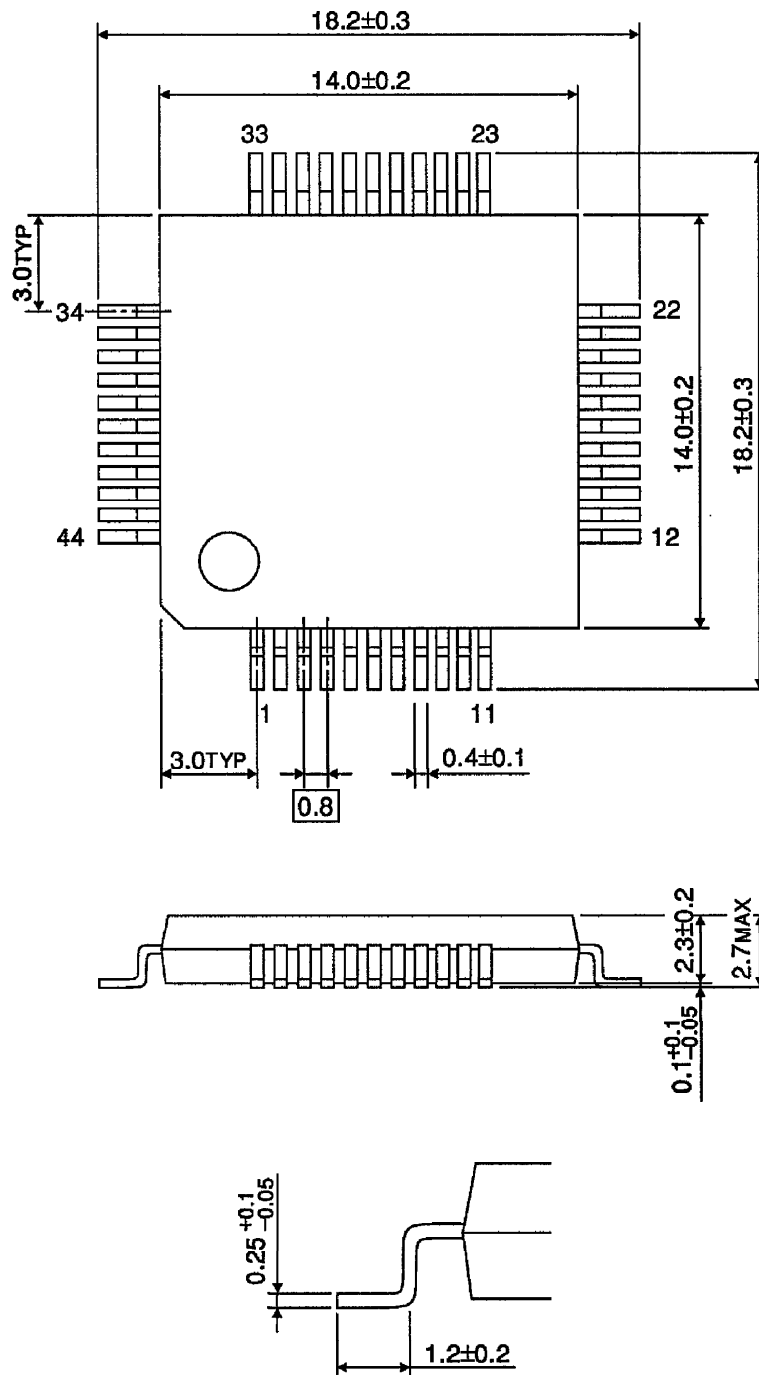

Weight : 1.15g (Typ.)

OUTLINE DRAWING
QFP44-P-1010-0.80C

Unit : mm

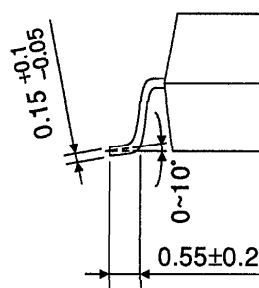
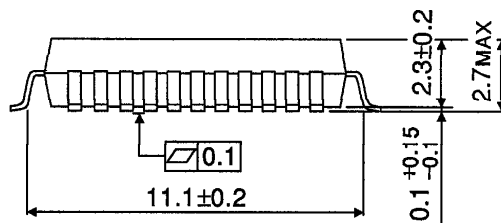
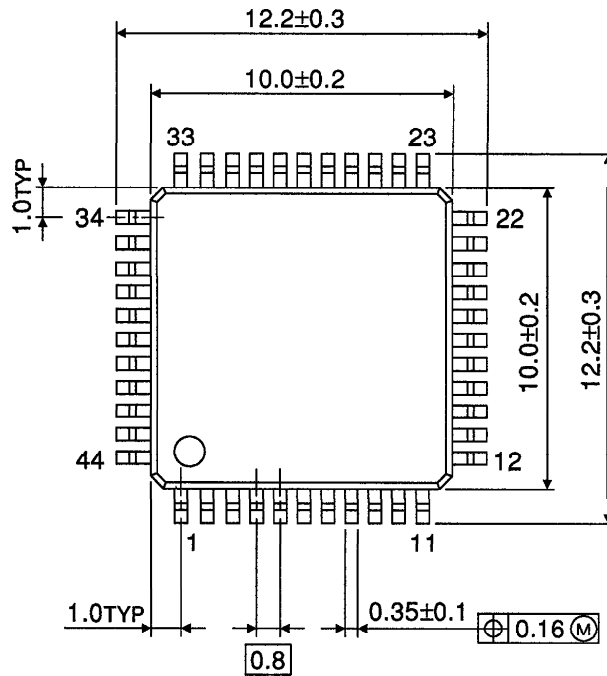

Weight : 0.5g (Typ.)