

Super Low Noise GaAs FETs

FEATURES

- Low Noise Figure: NF = 0.5 dB Typical at 12 GHz
- High Associated Gain: Ga = 13 dB Typical at 12 GHz
- Lg = 0.25 μm, Wg = 160 μm
- All-Gold Metallization for High Reliability
- Tight Vp ranges control
- High RF input power handling capability
- 100 % DC Tested

PHOTO ENLARGEMENT

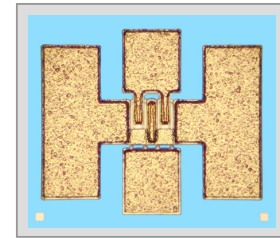

DESCRIPTION

The TC1102 is a GaAs Pseudomorphic High Electron Mobility Transistor (PHEMT) chip, which has very low noise figure and high associated gain. The device can be used in circuits up to 30 GHz and suitable for low noise application including a wide range of commercial and military applications. All devices are 100% DC tested to assure consistent quality. All bond pads are gold plated for either thermo-compression or thermo-sonic wire bonding.

ELECTRICAL SPECIFICATIONS (T_A=25 °C)

Symbol	Conditions	MIN	TYP	MAX	UNIT
NF	Noise Figure at V _{DS} = 2 V, I _{DS} = 10 mA, f = 12GHz		0.5	0.7	dB
G _a	Associated Gain at V _{DS} = 2 V, I _{DS} = 10 mA, f = 12GHz	11	13		dB
I _{DSS}	Saturated Drain-Source Current at V _{DS} = 2 V, V _{GS} = 0 V		48		mA
g _m	Transconductance at V _{DS} = 2 V, V _{GS} = 0 V		55		mS
V _P	Pinch-off Voltage at V _{DS} = 2 V, I _D = 0.32 mA		-1.0*		Volts
BV _{DGO}	Drain-Gate Breakdown Voltage at I _{DGO} = 0.08 mA	5	8		Volts
R _{th}	Thermal Resistance		225		°C/W

Note: * For the tight control of the pinch-off voltage, TC1102's are divided into 3 groups:

- (1) **TC1102P0710** : V_p = -0.7V to -1.0V (2) **TC1102P0811** : V_p = -0.8V to -1.1V (3) **TC1102P0912** : V_p = -0.9V to -1.2V
 In addition, the customers may specify their requirements.

ABSOLUTE MAXIMUM RATINGS (T_A=25 °C) TYPICAL NOISE PARAMETERS (T_A=25 °C)

$$V_{DS} = 2 \text{ V}, I_{DS} = 10 \text{ mA}$$

Symbol	Parameter	Rating	Frequency (GHz)	NF _{opt} (dB)	G _A (dB)	Γ _{opt}		Rn/50
						MAG	ANG	
V _{DS}	Drain-Source Voltage	5 V	2	0.30	19.0	0.98	15	0.40
V _{GS}	Gate-Source Voltage	-3.0 V	4	0.32	17.4	0.84	30	0.35
I _{DS}	Drain Current	I _{DSS}	6	0.34	15.7	0.68	50	0.26
I _{GS}	Gate Current	160 μA	8	0.37	14.3	0.51	76	0.19
P _{in}	RF Input Power, CW	17 dBm	10	0.42	12.9	0.38	107	0.12
P _T	Continuous Dissipation	250 mW	12	0.47	11.9	0.28	146	0.08
T _{CH}	Channel Temperature	175 °C	14	0.56	11.4	0.25	193	0.07
T _{STG}	Storage Temperature	- 65 °C to +175 °C	16	0.70	11.2	0.32	250	0.11
			18	0.87	10.9	0.49	317	0.23

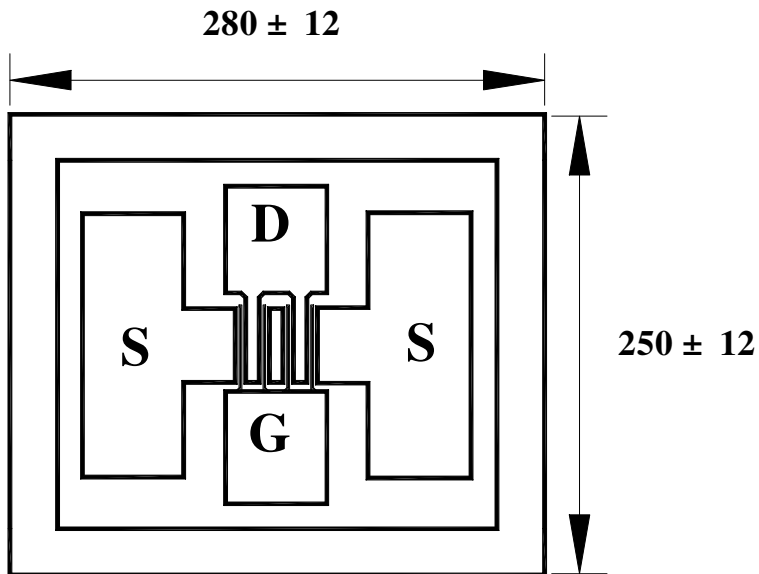
CHIP DIMENSIONS

Units: Micrometers
Chip Thickness: 100

Gate Pad: 55 x 60
Drain Pad: 55 x 60
Source Pad: 55 x 14

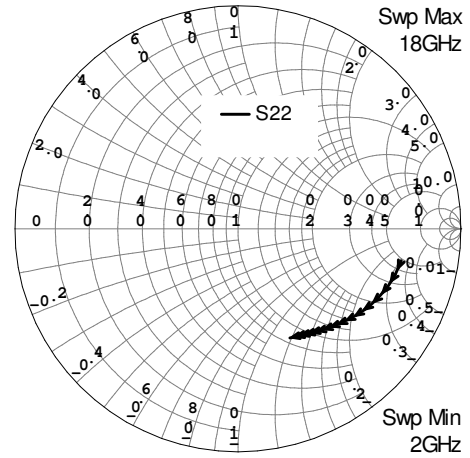
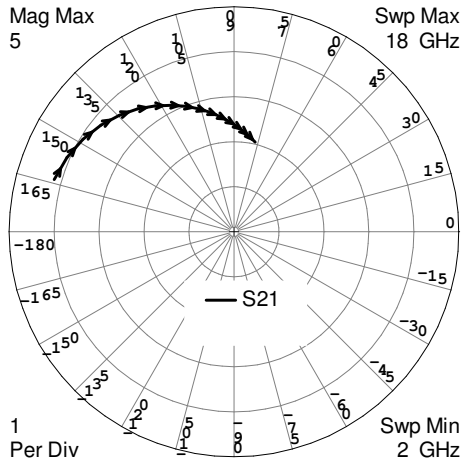
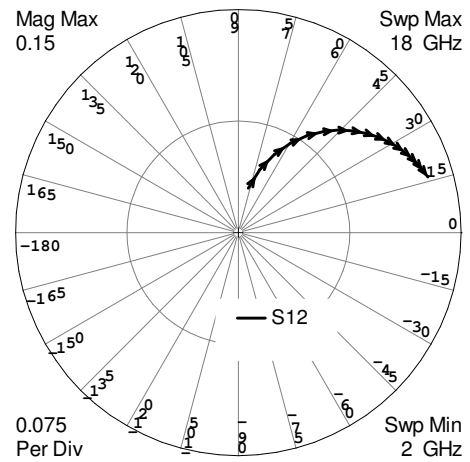
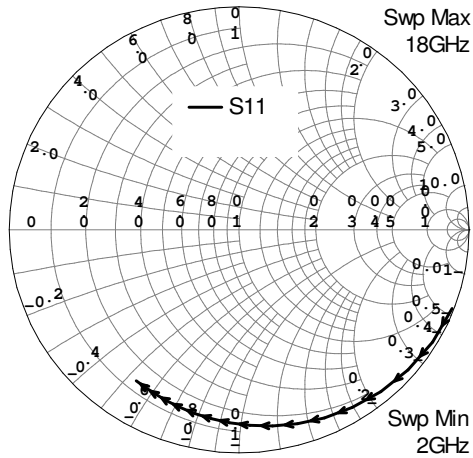
TYPICAL SCATTERING PARAMETERS (T_A=25 °C) V_{DS} = 2 V, I_{DS} = 10 mA

FREQUENCY (GHz)	S11		S21		S12		S22	
	MAG	ANG	MAG	ANG	MAG	ANG	MAG	ANG
2	0.9909	-20.88	4.1640	163.83	0.0305	77.18	0.7466	-11.01
3	0.9805	-30.94	4.0654	156.02	0.0447	71.04	0.7346	-16.27
4	0.9673	-40.57	3.9385	148.51	0.0577	65.20	0.7193	-21.26
5	0.9524	-49.69	3.7916	141.35	0.0694	59.71	0.7019	-25.95
6	0.9367	-58.26	3.6326	134.56	0.0798	54.59	0.6835	-30.31
7	0.9209	-66.26	3.4682	128.16	0.0888	49.85	0.6650	-34.35
8	0.9057	-73.69	3.3038	122.13	0.0966	45.48	0.6471	-38.08
9	0.8913	-80.57	3.1430	116.45	0.1033	41.45	0.6302	-41.53
10	0.8780	-86.92	2.9885	111.09	0.1090	37.74	0.6146	-44.73
11	0.8659	-92.79	2.8417	106.02	0.1139	34.32	0.6005	-47.70
12	0.8551	-98.22	2.7033	101.22	0.1181	31.16	0.5880	-50.49
13	0.8453	-103.24	2.5737	96.66	0.1216	28.24	0.5770	-53.11
14	0.8366	-107.89	2.4526	92.32	0.1247	25.52	0.5674	-55.59
15	0.8290	-112.20	2.3399	88.16	0.1272	22.98	0.5593	-57.95
16	0.8222	-116.22	2.2349	84.17	0.1295	20.61	0.5525	-60.21
17	0.8163	-119.96	2.1373	80.33	0.1313	18.38	0.5468	-62.39
18	0.8111	-123.45	2.0464	76.64	0.1329	16.28	0.5423	-64.49

* The data does not include gate, drain and source bond wires.

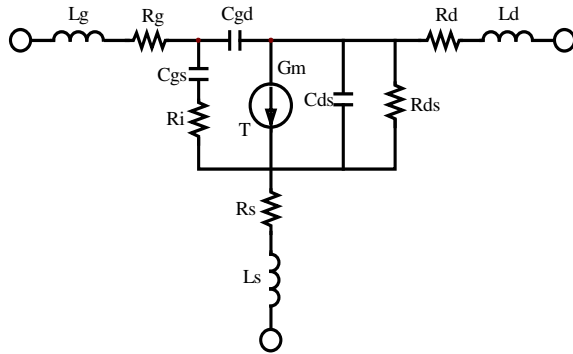
SMALL SIGNAL MODEL, $V_{DS} = 2\text{ V}$, $I_{DS} = 10\text{ mA}$
SCHEMATIC

PARAMETERS

Lg	0.038 nH	Rs	1.7200 Ohm
Rg	0.970 Ohm	Ls	0.0010 nH
Cgs	0.222 pF	Cds	0.0610 pF
Ri	1.780 Ohm	Rds	328.00 Ohm
Cgd	0.027 pF	Rd	1.6980 Ohm
Gm	53.30 mS	Ld	0.0229 nH
T	1.490 psec		

CHIP HANDLING

DIE ATTACHMENT: Conductive epoxy or eutectic die attach is recommended. Eutectic die attach can be accomplished with Au-Sn (80%Au-20%Sn) perform at stage temperature: $290^{\circ}\text{C} \pm 5^{\circ}\text{C}$; Handling Tool: Tweezers; Time: less than 1min.

WIRE BONDING: The recommended wire bond method is thermocompression bonding with 0.7 to 1.0 mil (0.018 to 0.025 mm) gold wire. Stage temperature: 220°C to 250°C ; Bond Tip Temperature: 150°C ; Bond Force: 20 to 30 gms depending on size of wire and Bond Tip Temperature.

HANDLING PRECAUTIONS: The user must operate in a clean, dry environment. Care should be exercised during handling avoid damage to the devices. Electrostatic Discharge (ESD) precautions should be observed at all stages of storage, handling, assembly, and testing. The static discharge must be less than 300V.