

50mA, 100mA, and 150mA CMOS LDOs with Shutdown and Error Output

Features

- Very Low Supply Current (55µA Typ.) for Longer Battery Life
- Very Low Dropout Voltage: 140mV (Typ.) @ 150mA
- High Output Voltage Accuracy: ±0.4% (Typ)
- Standard or Custom Output Voltages
- Power-Saving Shutdown Mode
- ERROR Output Can Be Used as a Low Battery Detector or Processor Reset Generator
- Fast Shutdown Reponse Time: 60µsec (Typ)
- Over-Current Protection
- Space-Saving 5-Pin SOT-23A Package
- Pin Compatible Upgrades for Bipolar Regulators

Applications

- Battery Operated Systems
- Portable Computers
- Medical Instruments
- Instrumentation
- Cellular / GSMS / PHS Phones
- Pagers

Device Selection Table

Part Number	Package	Junction Temp. Range
TC2054-xxVCT	5-Pin SOT-23A*	-40°C to +125°C
TC2055-xxVCT	5-Pin SOT-23A*	-40°C to +125°C
TC2186-xxVCT	5-Pin SOT-23A*	-40°C to +125°C

Note: *5-Pin SOT-23A is equivalent to EIAJ (SC-74A).

Package Type

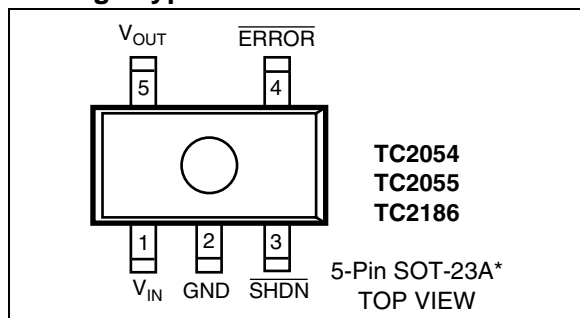

General Description

The TC2054, TC2055 and TC2186 are high accuracy (typically ±0.4%) CMOS upgrades for older (bipolar) low dropout regulators. Designed specifically for battery-operated systems, the devices' total supply current is typically 55µA at full load (20 to 60 times lower than in bipolar regulators).

The devices' key features include ultra low noise operation, very low dropout voltage - typically 45mV (TC2054); 90mV (TC2055); and 140mV (TC2186) at full load - and fast response to step changes in load. An error output ($\overline{\text{ERROR}}$) is asserted when the devices are out-of-regulation (due to a low input voltage or excessive output current). Supply current is reduced to 0.5µA (max) and both V_{OUT} and $\overline{\text{ERROR}}$ are disabled when the shutdown input is low. The devices also incorporate over-current protection.

The TC2054, TC2055 and TC2186 are stable with a low esr ceramic output capacitor of 1µF and have a maximum output current of 50mA, 100mA and 150mA, respectively. This LDO Family also features a fast response time (60µsec typically) when released from shutdown.

Typical Application

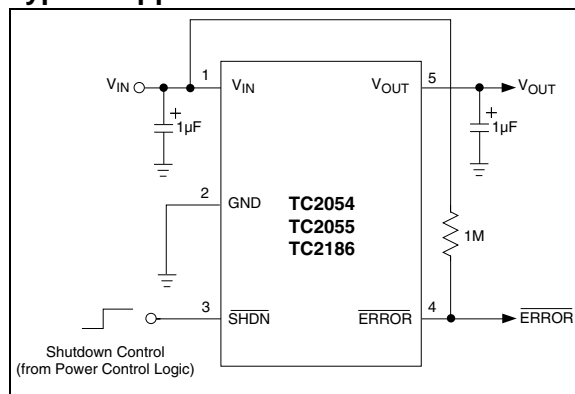

TC2054/2055/2186

1.0 ELECTRICAL CHARACTERISTICS

ABSOLUTE MAXIMUM RATINGS*

Input Voltage	6.5V
Output Voltage.....	(-0.3) to (V _{IN} + 0.3)
Operating Temperature	-40°C < T _J < 125°C
Storage Temperature.....	-65°C to +150°C
Maximum Voltage on Any Pin	V _{IN} +0.3V to -0.3V

*Stresses above those listed under “Absolute Maximum Ratings” may cause permanent damage to the device. These are stress ratings only and functional operation of the device at these or any other conditions above those indicated in the operation sections of the specifications is not implied. Exposure to Absolute Maximum Rating conditions for extended periods may affect device reliability.

TC2054/2055/2186 ELECTRICAL SPECIFICATIONS

Electrical Characteristics: V _{IN} = V _R + 1V, I _L = 100μA, C _L = 3.3μF, $\overline{\text{SHDN}} > V_{IH}$, T _A = 25°C, unless otherwise noted. BOLDFACE type specifications apply for junction temperature of -40°C to +125°C.						
Symbol	Parameter	Min	Typ	Max	Units	Test Conditions
V _{IN}	Input Operating Voltage	2.7	—	6.0	V	Note 1
I _{OUTMAX}	Maximum Output Current	50 100 150	—	—	mA	TC2054 TC2055 TC2186
V _{OUT}	Output Voltage	V_R - 2.0%	V _R ± 0.4%	V_R + 2.0%	V	Note 2
TCV _{OUT}	V _{OUT} Temperature Coefficient	—	20 40	—	ppm/°C	Note 3
$\frac{\Delta V_{OUT}}{\Delta V_{IN}}$	Line Regulation	—	0.05	0.5	%	(V _R + 1V) ≤ V _{IN} ≤ 6V
$\frac{\Delta V_{OUT}}{V_{OUT}}$	Load Regulation	-1.5 -2.5	0.5 0.5	0.5 0.5	%	TC2054; TC2055 I _L = 0.1mA to I _{OUTMAX} TC2186 I _L = 0.1mA to I _{OUTMAX} Note 4
V _{IN} - V _{OUT}	Dropout Voltage, Note 5	—	2 45 90 140	— 70 140 210	mV	I _L = 100μA I _L = 50mA TC2015; TC2185 I _L = 100mA TC2185 I _L = 150mA Note 5
I _{IN}	Supply Current	—	55	80	μA	$\overline{\text{SHDN}} = V_{IH}$, I _L = 0
I _{INSD}	Shutdown Supply Current	—	0.05	0.5	μA	$\overline{\text{SHDN}} = 0V$
PSRR	Power Supply Rejection Ratio	—	50	—	dB	F _{RE} ≤ 120kHz
I _{OUTSC}	Output Short Circuit Current	160	300	—	mA	V _{OUT} = 0V
$\Delta V_{OUT\Delta P_D}$	Thermal Regulation	—	0.04	—	V/W	Note 6
eN	Output Noise	—	600	—	nV / $\sqrt{\text{Hz}}$	I _L = I _{OUTMAX} , F = 10kHz
t _R	Response Time (from Shutdown Mode)	—	60	—	μsec	V _{IN} = 4V C _{IN} = 1μF, C _{OUT} = 10μF I _L = 0.1mA, Note 9

- Note 1:** The minimum V_{IN} has to meet two conditions: V_{IN} = 2.7V and V_{IN} = V_R + V_{DROPOUT}.
Note 2: V_R is the regulator output voltage setting. For example: V_R = 1.8V, 2.7V, 2.8V, 2.85V, 3.0V, 3.3V.

Note 3:
$$TCV_{OUT} = \frac{(V_{OUTMAX} - V_{OUTMIN}) \times 10^6}{V_{OUT} \times \Delta T}$$

- 4:** Regulation is measured at a constant junction temperature using low duty cycle pulse testing. Load regulation is tested over a load range from 1.0mA to the maximum specified output current. Changes in output voltage due to heating effects are covered by the thermal regulation specification.
5: Dropout voltage is defined as the input to output differential at which the output voltage drops 2% below its nominal value at a 1V differential.
6: Thermal Regulation is defined as the change in output voltage at a time T after a change in power dissipation is applied, excluding load or line regulation effects. Specifications are for a current pulse equal to I_{MAX} at V_{IN} = 6V for T = 10msec.
7: The maximum allowable power dissipation is a function of ambient temperature, the maximum allowable junction temperature and the thermal resistance from junction-to-air (i.e. T_A, T_J, θ_{JA}).
8: Hysteresis voltage is referenced by V_R.
9: Time required for V_{OUT} to reach 95% of V_R (output voltage setting), after V_{SHDN} is switched from 0 to V_{IN}.

Electrical Characteristics: $V_{IN} = V_R + 1V$, $I_L = 100\mu A$, $C_L = 3.3\mu F$, $\overline{SHDN} > V_{IH}$, $T_A = 25^\circ C$, unless otherwise noted. **BOLDFACE** type specifications apply for junction temperature of $-40^\circ C$ to $+125^\circ C$.

Symbol	Parameter	Min	Typ	Max	Units	Test Conditions
SHDN Input						
V_{IH}	SHDN Input High Threshold	60	—	—	% V_{IN}	$V_{IN} = 2.5V$ to $6.0V$
V_{IL}	SHDN Input Low Threshold	—	—	15	% V_{IN}	$V_{IN} = 2.5V$ to $6.0V$
ERROR OUTPUT						
V_{INMIN}	Minimum V_{IN} Operating Voltage	1.0	—	—	V	$V_{OUT} \geq 2.7V$
V_{OL}	Output Logic Low Voltage	—	—	400	mV	1 mA Flows to \overline{ERROR}
V_{TH}	\overline{ERROR} Threshold Voltage	—	$0.95 \times V_R$	—	V	See Figure 4-2
V_{HYS}	\overline{ERROR} Positive Hysteresis	—	50	—	mV	Note 8
t_{DELAY}	V_{OUT} to \overline{ERROR} Delay	—	2	—	msec	V_{OUT} from $V_R = 3V$ to $2.8V$
R_{ERROR}	Resistance from \overline{ERROR} to GND	—	126	—	Ω	$V_{DD} = 2.5V$, $V_{OUT} = 2.5V$

Note 1: The minimum V_{IN} has to meet two conditions: $V_{IN} = 2.7V$ and $V_{IN} = V_R + V_{DROPOUT}$.

2: V_R is the regulator output voltage setting. For example: $V_R = 1.8V, 2.7V, 2.8V, 2.85V, 3.0V, 3.3V$.

3: $TCV_{OUT} = \frac{(V_{OUTMAX} - V_{OUTMIN}) \times 10^6}{V_{OUT} \times \Delta T}$

4: Regulation is measured at a constant junction temperature using low duty cycle pulse testing. Load regulation is tested over a load range from 1.0mA to the maximum specified output current. Changes in output voltage due to heating effects are covered by the thermal regulation specification.

5: Dropout voltage is defined as the input to output differential at which the output voltage drops 2% below its nominal value at a 1V differential.

6: Thermal Regulation is defined as the change in output voltage at a time T after a change in power dissipation is applied, excluding load or line regulation effects. Specifications are for a current pulse equal to I_{MAX} at $V_{IN} = 6V$ for $T = 10msec$.

7: The maximum allowable power dissipation is a function of ambient temperature, the maximum allowable junction temperature and the thermal resistance from junction-to-air (i.e. T_A, T_J, θ_{JA}).

8: Hysteresis voltage is referenced by V_R .

9: Time required for V_{OUT} to reach 95% of V_R (output voltage setting), after V_{SHDN} is switched from 0 to V_{IN} .

2.0 PIN DESCRIPTIONS

The descriptions of the pins are listed in Table 2-1.

TABLE 2-1: PIN FUNCTION TABLE

Pin Number	Symbol	Description
1	V_{IN}	Unregulated supply input.
2	GND	Ground terminal.
3	\overline{SHDN}	Shutdown control input. The regulator is fully enabled when a logic high is applied to this input. The regulator enters shutdown when a logic low is applied to this input. During shutdown, output voltage falls to zero, \overline{ERROR} is open circuited and supply current is reduced to $0.5\mu A$ (max).
4	\overline{ERROR}	Out-of-Regulation Flag. (Open drain output). This output goes low when V_{OUT} is out-of-tolerance by approximately -5%.
5	V_{OUT}	Regulated voltage output.

TC2054/2055/2186

3.0 DETAILED DESCRIPTION

The TC2054, TC2055 and TC2186 are precision fixed output voltage regulators. (If an adjustable version is desired, please see the TC1070, TC1071 or TC1187 data sheets.) Unlike bipolar regulators, the TC2054, TC2055 and TC2186 supply current does not increase with load current. In addition, V_{OUT} remains stable and within regulation over the entire 0mA to maximum output current operating load range.

Figure 3-1 shows a typical application circuit. The regulator is enabled any time the shutdown input (SHDN) is at or above V_{IH} , and shutdown (disabled) when SHDN is at or below V_{IL} . SHDN may be controlled by a CMOS logic gate, or I/O port of a microcontroller. If the SHDN input is not required, it should be connected directly to the input supply. While in shutdown, supply current decreases to 0.05 μ A (typical), V_{OUT} falls to zero volts, and ERROR is open-circuited.

FIGURE 3-1: TYPICAL APPLICATION CIRCUIT

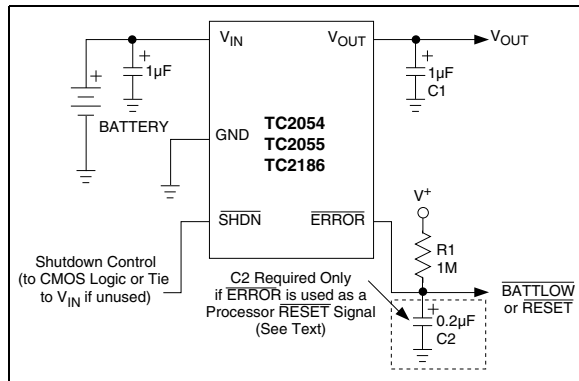

3.1 ERROR Open Drain Output

$\overline{\text{ERROR}}$ is driven low whenever V_{OUT} falls out of regulation by more than -5% (typical). This condition may be caused by low input voltage, output current limiting or thermal limiting. The ERROR threshold is 5% below rated V_{OUT} regardless of the programmed output voltage value (e.g. $\overline{\text{ERROR}} = V_{OL}$ at 4.75V (typ.) for a 5.0V regulator and 2.85V (typ.) for a 3.0V regulator). $\overline{\text{ERROR}}$ output operation is shown in Figure 4-2.

Note that $\overline{\text{ERROR}}$ is active when V_{OUT} falls to V_{TH} , and inactive when V_{OUT} rises above V_{TH} by V_{HYS} .

As shown in Figure 3-1, $\overline{\text{ERROR}}$ can be used as a battery low flag or as a processor $\overline{\text{RESET}}$ signal (with the addition of timing capacitor C2). $R1 \times C2$ should be chosen to maintain $\overline{\text{ERROR}}$ below V_{IH} of the processor $\overline{\text{RESET}}$ input for at least 200msec to allow time for the system to stabilize. Pull-up resistor R1 can be tied to V_{OUT} , V_{IN} or any other voltage less than $(V_{IN} + 0.3V)$. The ERROR pin sink current is self-limiting to approximately 18mA.

FIGURE 3-2: ERROR OUTPUT OPERATION

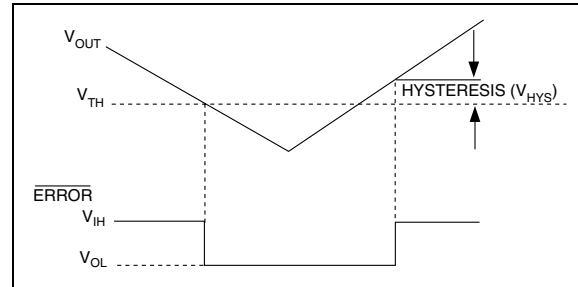

3.2 Output Capacitor

A 1 μ F (min) capacitor from V_{OUT} to ground is required. The output capacitor should have an effective series resistance of 0.01 Ω to 5 Ω for $V_{OUT} = 2.5V$, and 0.05 Ω to 5 Ω for $V_{OUT} < 2.5V$. A 1 μ F capacitor should be connected from V_{IN} to GND if there is more than 10 inches of wire between the regulator and the AC filter capacitor, or if a battery is used as the power source. Ceramic, tantalum and aluminum electrolytic capacitors can be used. (Since many aluminum electrolytic capacitors freeze at approximately -30 $^{\circ}$ C, solid tantalums are recommended for applications operating below -25 $^{\circ}$ C). When operating from sources other than batteries, supply-noise rejection and transient response can be improved by increasing the value of the input and output capacitors and employing passive filtering techniques.

4.0 THERMAL CONSIDERATIONS

4.1 Power Dissipation

The amount of power the regulator dissipates is primarily a function of input and output voltage, and output current.

The following equation is used to calculate worst case power dissipation:

EQUATION 4-1:

$$P_D \approx (V_{IN} - V_{OUTMIN}) I_{LOADMAX}$$

Where:

P_D	=	Worst case actual power dissipation
V_{INMAX}	=	Maximum voltage on V_{IN}
V_{OUTMIN}	=	Minimum regulator output voltage
$I_{LOADMAX}$	=	Maximum output (load) current

The maximum allowable power dissipation (Equation 4-2) is a function of the maximum ambient temperature (T_{AMAX}), the maximum allowable die temperature (125 °C) and the thermal resistance from junction-to-air (θ_{JA}). The 5-Pin SOT-23A package has a θ_{JA} of approximately 220°C/Watt when mounted on a typical two layer FR4 dielectric copper clad PC board.

EQUATION 4-2:

$$P_{D_{MAX}} = \frac{T_{J_{MAX}} - T_{A_{MAX}}}{\theta_{JA}}$$

Where all terms are previously defined

Equation 4-1 can be used in conjunction with Equation 4-2 to ensure regulator thermal operation is within limits. For example:

Given:

$$\begin{aligned} V_{INMAX} &= 3.0V \pm 5\% \\ V_{OUTMIN} &= 2.7V - 2.5\% \\ I_{LOADMAX} &= 40mA \\ T_{AMAX} &= 55^\circ C \end{aligned}$$

Find 1. Actual power dissipation

:

2. Maximum allowable dissipation

Actual power dissipation:

$$\begin{aligned} P_D &\approx (V_{INMAX} - V_{OUTMIN}) I_{LOADMAX} \\ &= [(3.0 \times 1.05) - (2.7 \times .975)] 40 \times 10^{-3} \\ &= 20.7mW \end{aligned}$$

Maximum allowable power dissipation:

$$P_{D_{MAX}} = \frac{(T_{J_{MAX}} - T_{A_{MAX}})}{\theta_{JA}}$$

$$\frac{(125 - 55)}{220}$$

$$= 318mW$$

In this example, the TC2054 dissipates a maximum of only 20.7mW; far below the allowable limit of 318mW. In a similar manner, Equation 4-1 and Equation 4-2 can be used to calculate maximum current and/or input voltage limits.

4.2 Layout Considerations

The primary path of heat conduction out of the package is via the package leads. Therefore, layouts having a ground plane, wide traces at the pads, and wide power supply bus lines combine to lower θ_{JA} and, therefore, increase the maximum allowable power dissipation limit.

TC2054/2055/2186

5.0 TYPICAL CHARACTERISTICS

Note: The graphs and tables provided following this note are a statistical summary based on a limited number of samples and are provided for informational purposes only. The performance characteristics listed herein are not tested or guaranteed. In some graphs or tables, the data presented may be outside the specified operating range (e.g., outside specified power supply range) and therefore outside the warranted range.

FIGURE 5-1: POWER SUPPLY REJECTION RATIO

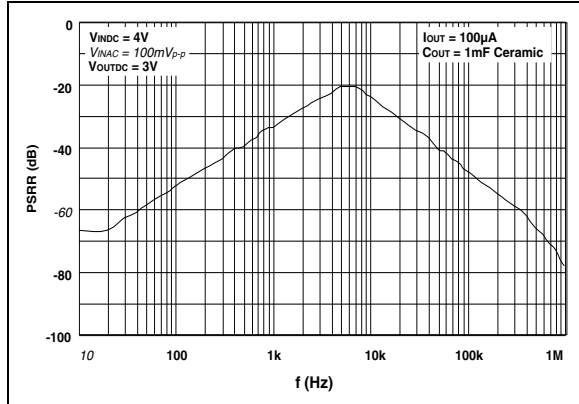

FIGURE 5-4: POWER SUPPLY REJECTION RATIO

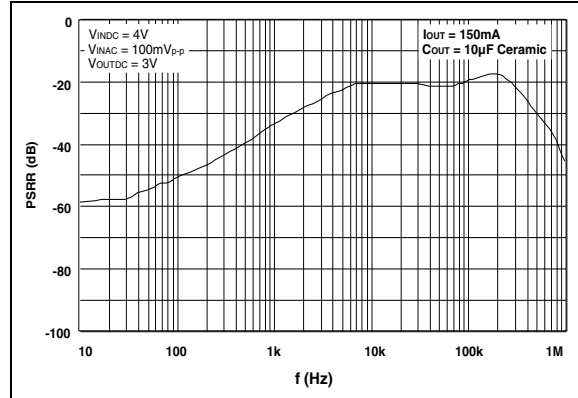

FIGURE 5-2: POWER SUPPLY REJECTION RATIO

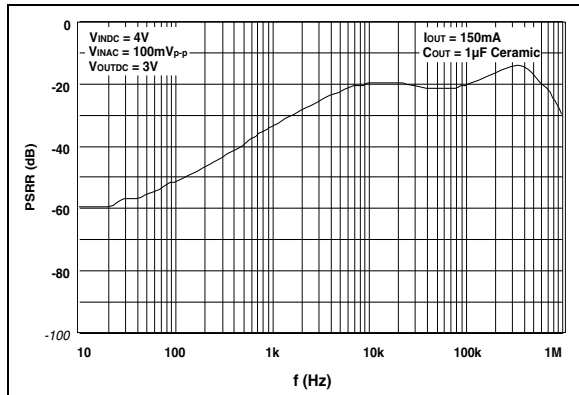

FIGURE 5-5: POWER SUPPLY REJECTION RATIO

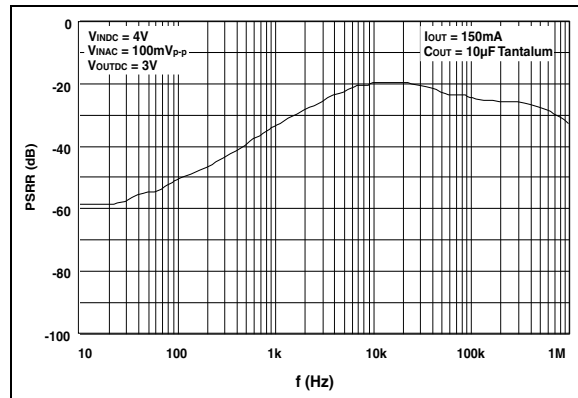

FIGURE 5-3: OUTPUT NOISE

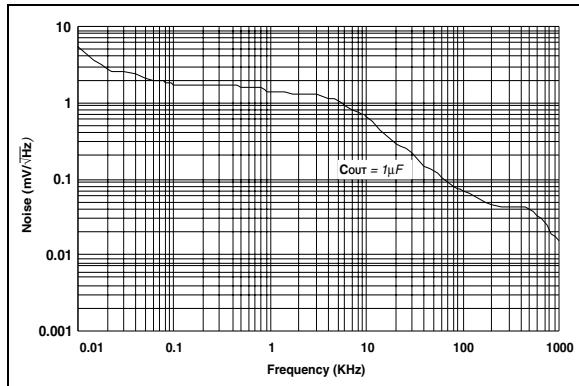
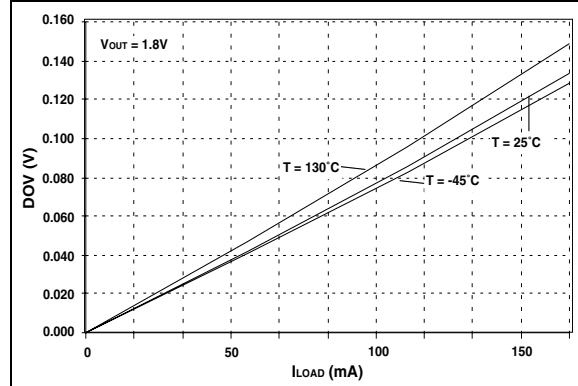

FIGURE 5-6: DROPOUT VOLTAGE VS. I_{LOAD}



TYPICAL CHARACTERISTICS (CONT)

FIGURE 5-7: I_{DD} VS. TEMPERATURE

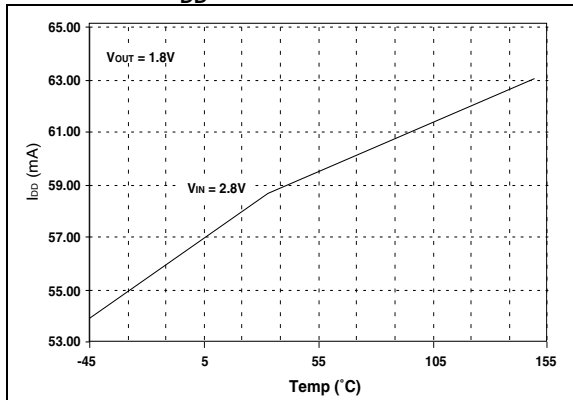

FIGURE 5-8: OUTPUT VOLTAGE VS. TEMPERATURE

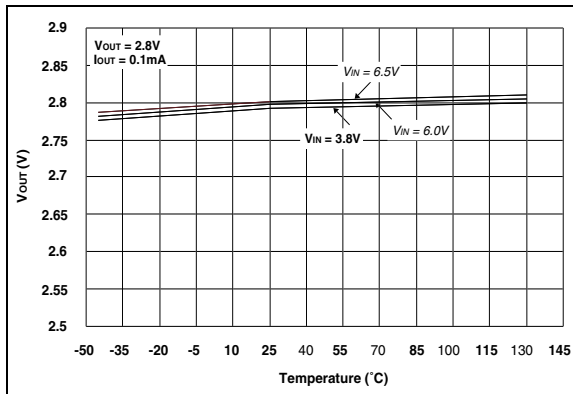

FIGURE 5-9: OUTPUT VOLTAGE VS. TEMPERATURE

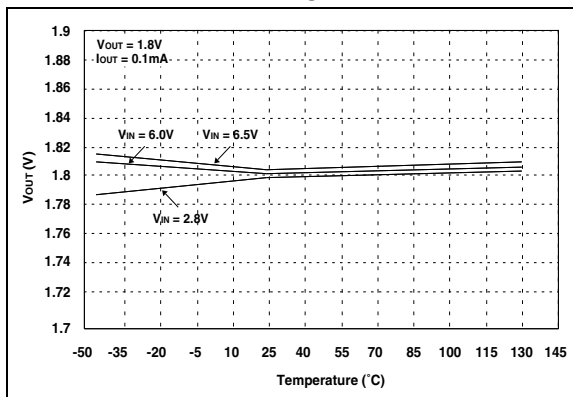

FIGURE 5-10: OUTPUT VOLTAGE VS. OUTPUT CURRENT

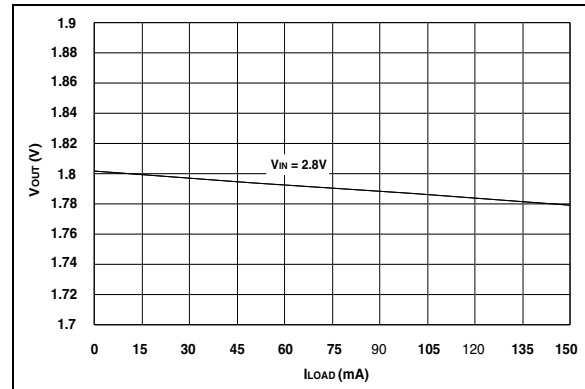

FIGURE 5-11: OUTPUT VOLTAGE VS. SUPPLY VOLTAGE

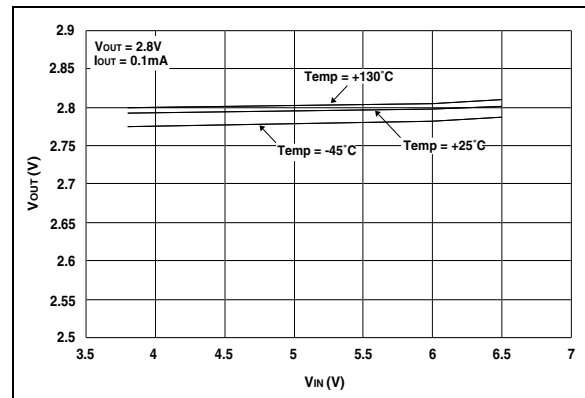
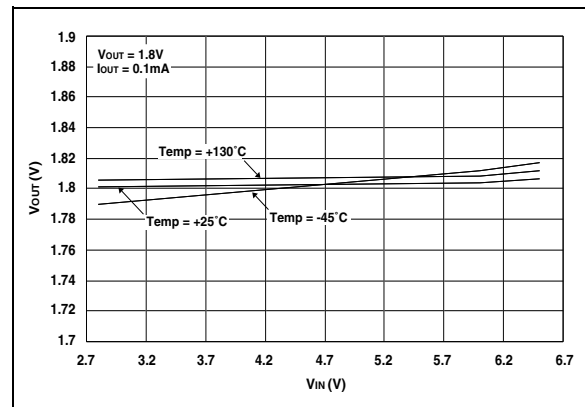

FIGURE 5-12: OUTPUT VOLTAGE VS. SUPPLY VOLTAGE



TC2054/2055/2186

TYPICAL CHARACTERISTICS (CONT)

FIGURE 5-13: LOAD TRANSIENT RESPONSE

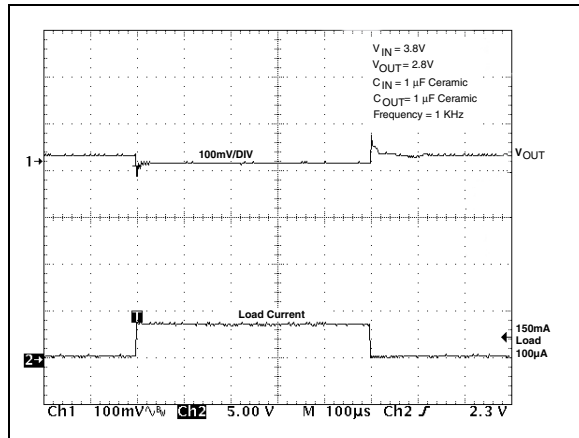

FIGURE 5-14: LOAD TRANSIENT RESPONSE IN DROPOUT MODE

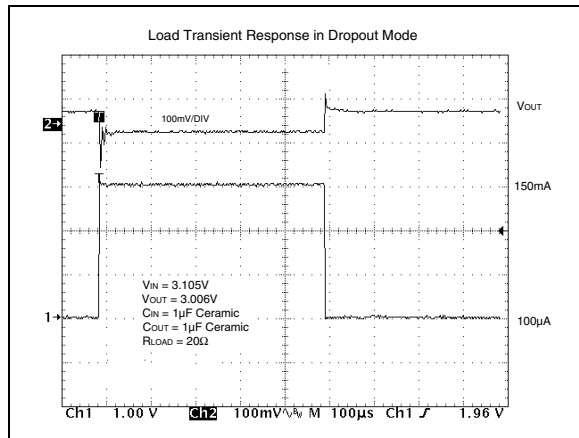

FIGURE 5-15: LINE TRANSIENT RESPONSE

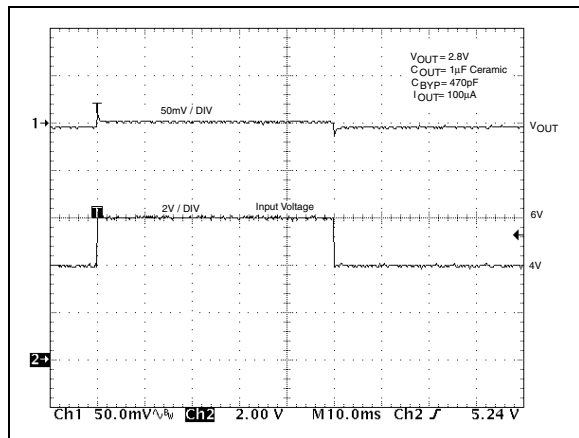

FIGURE 5-16: LOAD TRANSIENT RESPONSE

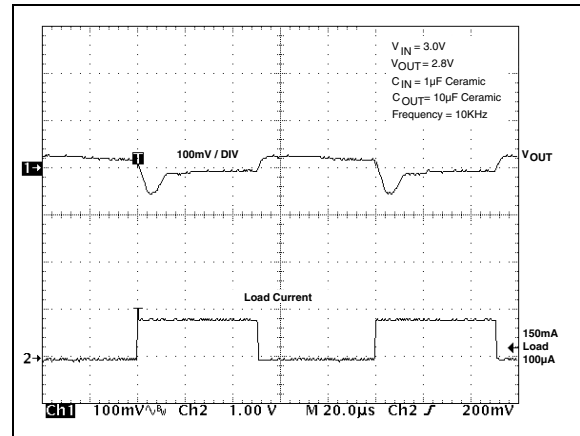

FIGURE 5-17: SHUTDOWN DELAY

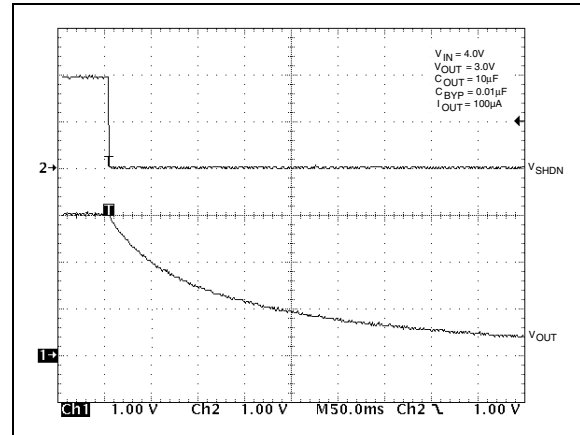
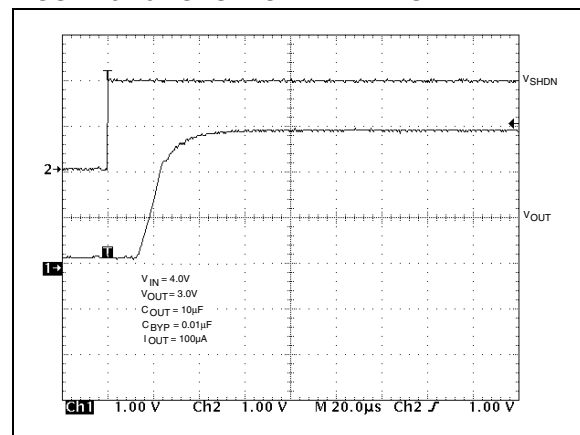
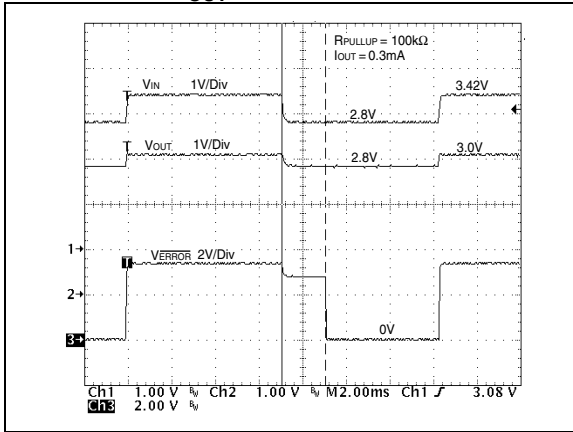

FIGURE 5-18: SHUTDOWN WAKE-UP TIME



TYPICAL CHARACTERISTICS (CONT)

FIGURE 5-19: V_{OUT} TO \overline{ERROR} DELAY



TC2054/2055/2186

6.0 PACKAGING INFORMATION

6.1 Package Marking Information

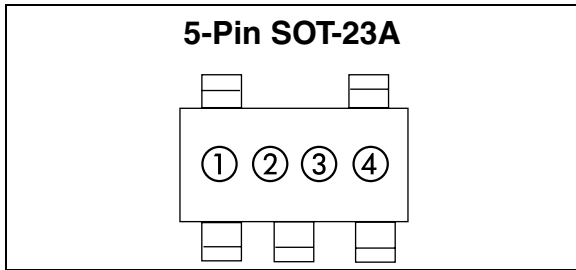

1 & 2 = part number code + temperature range and voltage

(V)	<u>TC2054</u> Code	<u>TC2055</u> Code	<u>TC2186</u> Code
1.8	SA	TA	VA
2.5	SB	TB	VB
2.7	SC	TC	VC
2.8	SD	TD	VD
2.85	SE	TE	VE
3.0	SF	TF	VF
3.3	SG	TG	VG

3 represents year and 2-month period code

4 represents lot ID number

6.2 Taping Information

Component Taping Orientation for 5-Pin SOT-23A (EIAJ SC-74A) Devices

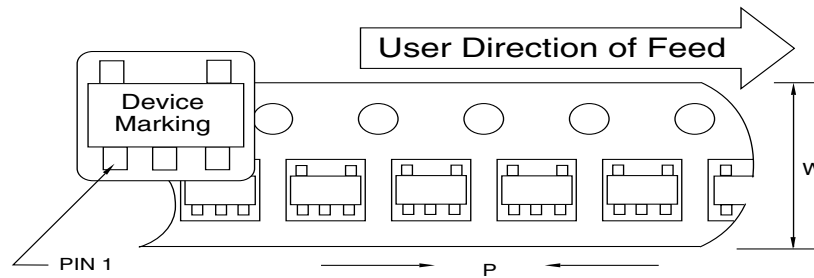

Standard Reel Component Orientation
TR Suffix Device
(Mark Right Side Up)

Reverse Reel Component Orientation
RT Suffix Device
(Mark Upside Down)

Carrier Tape, Number of Components Per Reel and Reel Size

Package	Carrier Width (W)	Pitch (P)	Part Per Full Reel	Reel Size
5-Pin SOT-23A	8 mm	4 mm	3000	7 in

6.3 Package Dimensions

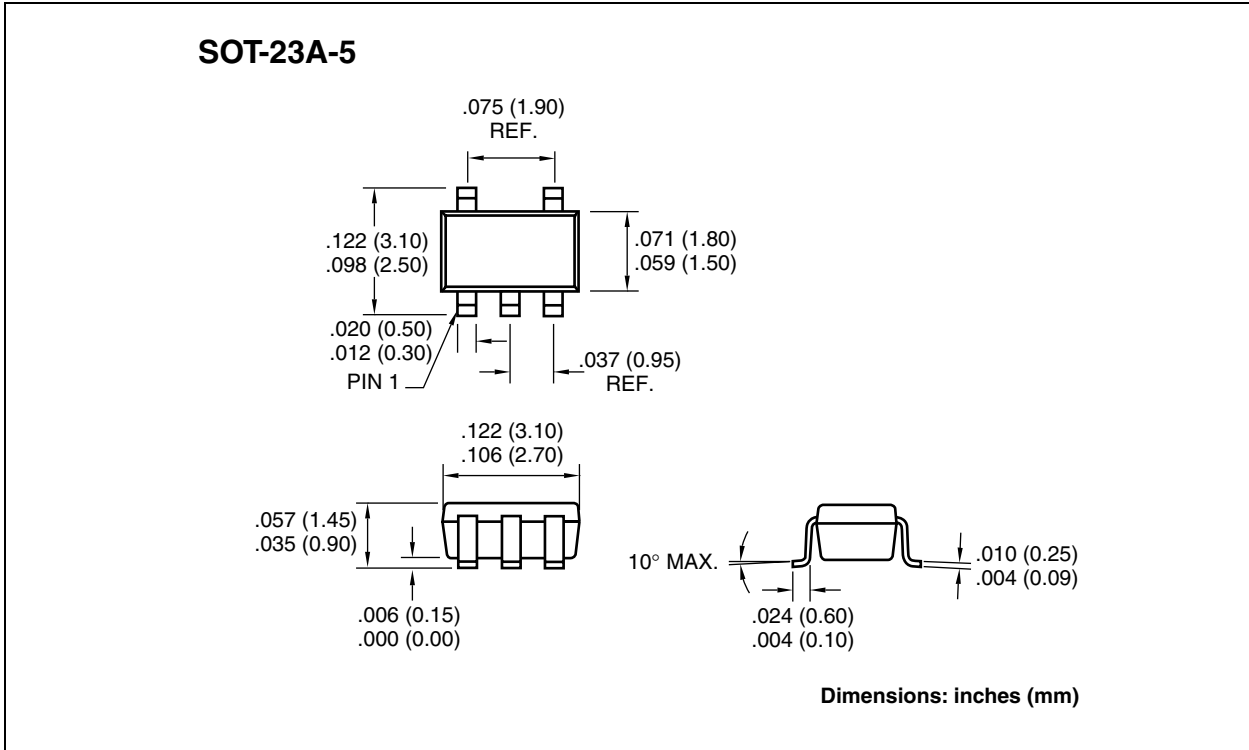

TC2054/2055/2186

NOTES:

SALES AND SUPPORT

Data Sheets

Products supported by a preliminary Data Sheet may have an errata sheet describing minor operational differences and recommended workarounds. To determine if an errata sheet exists for a particular device, please contact one of the following:

1. Your local Microchip sales office
2. The Microchip Corporate Literature Center U.S. FAX: (480) 792-7277
3. The Microchip Worldwide Site (www.microchip.com)

Please specify which device, revision of silicon and Data Sheet (include Literature #) you are using.

New Customer Notification System

Register on our web site (www.microchip.com/cn) to receive the most current information on our products.

TC2054/2055/2186

NOTES:

Information contained in this publication regarding device applications and the like is intended through suggestion only and may be superseded by updates. It is your responsibility to ensure that your application meets with your specifications. No representation or warranty is given and no liability is assumed by Microchip Technology Incorporated with respect to the accuracy or use of such information, or infringement of patents or other intellectual property rights arising from such use or otherwise. Use of Microchip's products as critical components in life support systems is not authorized except with express written approval by Microchip. No licenses are conveyed, implicitly or otherwise, under any intellectual property rights.

Trademarks

The Microchip name and logo, the Microchip logo, FilterLab, KEELOQ, microID, MPLAB, PIC, PICmicro, PICMASTER, PICSTART, PRO MATE, SEEVAL and The Embedded Control Solutions Company are registered trademarks of Microchip Technology Incorporated in the U.S.A. and other countries.

dsPIC, ECONOMONITOR, FanSense, FlexROM, fuzzyLAB, In-Circuit Serial Programming, ICSP, ICEPIC, microPort, Migratable Memory, MPASM, MPLIB, MPLINK, MPSIM, MXDEV, PICC, PICDEM, PICDEM.net, rfPIC, Select Mode and Total Endurance are trademarks of Microchip Technology Incorporated in the U.S.A.

Serialized Quick Turn Programming (SQTP) is a service mark of Microchip Technology Incorporated in the U.S.A.

All other trademarks mentioned herein are property of their respective companies.

© 2002, Microchip Technology Incorporated, Printed in the U.S.A., All Rights Reserved.

 Printed on recycled paper.

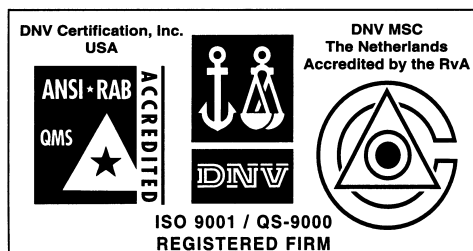

Microchip received QS-9000 quality system certification for its worldwide headquarters, design and wafer fabrication facilities in Chandler and Tempe, Arizona in July 1999 and Mountain View, California in March 2002. The Company's quality system processes and procedures are QS-9000 compliant for its PICmicro® 8-bit MCUs, KEELOQ® code hopping devices, Serial EEPROMs, microperipherals, non-volatile memory and analog products. In addition, Microchip's quality system for the design and manufacture of development systems is ISO 9001 certified.



MICROCHIP

WORLDWIDE SALES AND SERVICE

AMERICAS

Corporate Office

2355 West Chandler Blvd.
Chandler, AZ 85224-6199
Tel: 480-792-7200 Fax: 480-792-7277
Technical Support: 480-792-7627
Web Address: <http://www.microchip.com>

Rocky Mountain

2355 West Chandler Blvd.
Chandler, AZ 85224-6199
Tel: 480-792-7966 Fax: 480-792-7456

Atlanta

500 Sugar Mill Road, Suite 200B
Atlanta, GA 30350
Tel: 770-640-0034 Fax: 770-640-0307

Boston

2 Lan Drive, Suite 120
Westford, MA 01886
Tel: 978-692-3848 Fax: 978-692-3821

Chicago

333 Pierce Road, Suite 180
Itasca, IL 60143
Tel: 630-285-0071 Fax: 630-285-0075

Dallas

4570 Westgrove Drive, Suite 160
Addison, TX 75001
Tel: 972-818-7423 Fax: 972-818-2924

Detroit

Tri-Atria Office Building
32255 Northwestern Highway, Suite 190
Farmington Hills, MI 48334
Tel: 248-538-2250 Fax: 248-538-2260

Kokomo

2767 S. Albright Road
Kokomo, Indiana 46902
Tel: 765-864-8360 Fax: 765-864-8387

Los Angeles

18201 Von Karman, Suite 1090
Irvine, CA 92612
Tel: 949-263-1888 Fax: 949-263-1338

New York

150 Motor Parkway, Suite 202
Hauppauge, NY 11788
Tel: 631-273-5305 Fax: 631-273-5335

San Jose

Microchip Technology Inc.
2107 North First Street, Suite 590
San Jose, CA 95131
Tel: 408-436-7950 Fax: 408-436-7955

Toronto

6285 Northam Drive, Suite 108
Mississauga, Ontario L4V 1X5, Canada
Tel: 905-673-0699 Fax: 905-673-6509

ASIA/PACIFIC

Australia

Microchip Technology Australia Pty Ltd
Suite 22, 41 Rawson Street
Epping 2121, NSW
Australia
Tel: 61-2-9868-6733 Fax: 61-2-9868-6755

China - Beijing

Microchip Technology Consulting (Shanghai)
Co., Ltd., Beijing Liaison Office
Unit 915
Bei Hai Wan Tai Bldg.
No. 6 Chaoyangmen Beidajie
Beijing, 100027, No. China
Tel: 86-10-85282100 Fax: 86-10-85282104

China - Chengdu

Microchip Technology Consulting (Shanghai)
Co., Ltd., Chengdu Liaison Office
Rm. 2401, 24th Floor,
Ming Xing Financial Tower
No. 88 TIDU Street
Chengdu 610016, China
Tel: 86-28-6766200 Fax: 86-28-6766599

China - Fuzhou

Microchip Technology Consulting (Shanghai)
Co., Ltd., Fuzhou Liaison Office
Unit 28F, World Trade Plaza
No. 71 Wusi Road
Fuzhou 350001, China
Tel: 86-591-7503506 Fax: 86-591-7503521

China - Shanghai

Microchip Technology Consulting (Shanghai)
Co., Ltd.
Room 701, Bldg. B
Far East International Plaza
No. 317 Xian Xia Road
Shanghai, 200051
Tel: 86-21-6275-5700 Fax: 86-21-6275-5060

China - Shenzhen

Microchip Technology Consulting (Shanghai)
Co., Ltd., Shenzhen Liaison Office
Rm. 1315, 13/F, Shenzhen Kerry Centre,
Renminnan Lu
Shenzhen 518001, China
Tel: 86-755-2350361 Fax: 86-755-2366086

Hong Kong

Microchip Technology Hongkong Ltd.
Unit 901-6, Tower 2, Metroplaza
223 Hing Fong Road
Kwai Fong, N.T., Hong Kong
Tel: 852-2401-1200 Fax: 852-2401-3431

India

Microchip Technology Inc.
India Liaison Office
Divyasree Chambers
1 Floor, Wing A (A3/A4)
No. 11, O'Shaugnessey Road
Bangalore, 560 025, India
Tel: 91-80-2290061 Fax: 91-80-2290062

Japan

Microchip Technology Japan K.K.
Benex S-1 6F
3-18-20, Shinyokohama
Kohoku-Ku, Yokohama-shi
Kanagawa, 222-0033, Japan
Tel: 81-45-471-6166 Fax: 81-45-471-6122

Korea

Microchip Technology Korea
168-1, Youngbo Bldg. 3 Floor
Samsung-Dong, Kangnam-Ku
Seoul, Korea 135-882
Tel: 82-2-554-7200 Fax: 82-2-558-5934

Singapore

Microchip Technology Singapore Pte Ltd.
200 Middle Road
#07-02 Prime Centre
Singapore, 188980
Tel: 65-6334-8870 Fax: 65-6334-8850

Taiwan

Microchip Technology Taiwan
11F-3, No. 207
Tung Hua North Road
Taipei, 105, Taiwan
Tel: 886-2-2717-7175 Fax: 886-2-2545-0139

EUROPE

Denmark

Microchip Technology Nordic ApS
Regus Business Centre
Lautrup høj 1-3
Ballerup DK-2750 Denmark
Tel: 45 4420 9895 Fax: 45 4420 9910

France

Microchip Technology SARL
Parc d'Activite du Moulin de Massy
43 Rue du Saule Trapu
Batiment A - 1er Etage
91300 Massy, France
Tel: 33-1-69-53-63-20 Fax: 33-1-69-30-90-79

Germany

Microchip Technology GmbH
Gustav-Heinemann Ring 125
D-81739 Munich, Germany
Tel: 49-89-627-144 0 Fax: 49-89-627-144-44

Italy

Microchip Technology SRL
Centro Direzionale Colleoni
Palazzo Taurus 1 V. Le Colleoni 1
20041 Agrate Brianza
Milan, Italy
Tel: 39-039-65791-1 Fax: 39-039-6899883

United Kingdom

Arizona Microchip Technology Ltd.
505 Eskdale Road
Winnersh Triangle
Wokingham
Berkshire, England RG41 5TU
Tel: 44 118 921 5869 Fax: 44-118 921-5820

03/01/02

