

Plastic Packaged Low Noise PHEMT GaAs FETs

FEATURES

- 1.5 dB Typical Noise Figure at 12 GHz
- High Associated Gain: $G_a = 7$ dB Typical at 12 GHz
- 18.5 dBm Typical Power at 12 GHz
- 8 dB Typical Linear Power Gain at 12 GHz
- $L_g = 0.25 \mu\text{m}$, $W_g = 160 \mu\text{m}$
- Tight V_p ranges control
- High RF input power handling capability
- 100 % DC Tested
- Low Cost Plastic SOT143 Package

PHOTO ENLARGEMENT



DESCRIPTION

The TC2111 is a high performance field effect transistor housed in a plastic package with TC1101 PHEMT Chip. Its low noise figure makes this device suitable for use in low noise amplifiers. All devices are 100 % DC tested to assure consistent quality.

ELECTRICAL SPECIFICATIONS ($T_A=25^\circ\text{C}$)

Symbol	CONDITIONS	MIN	TYP	MAX	UNIT
NF	Noise Figure at $V_{DS} = 2 \text{ V}$, $I_{DS} = 10 \text{ mA}$, $f = 12\text{GHz}$		1.5	1.8	dB
G_a	Associated Gain at $V_{DS} = 2 \text{ V}$, $I_{DS} = 10 \text{ mA}$, $f = 12\text{GHz}$	6	7		dB
P_{1dB}	Output Power at 1dB Gain Compression Point, $f = 12\text{GHz}$ $V_{DS} = 6 \text{ V}$, $I_{DS} = 25 \text{ mA}$	17.5	18.5		dBm
G_L	Linear Power Gain, $f = 12\text{GHz}$ $V_{DS} = 6 \text{ V}$, $I_{DS} = 25 \text{ mA}$	7	8		dB
I_{DSS}	Saturated Drain-Source Current at $V_{DS} = 2 \text{ V}$, $V_{GS} = 0 \text{ V}$		48		mA
g_m	Transconductance at $V_{DS} = 2 \text{ V}$, $V_{GS} = 0 \text{ V}$		55		mS
V_p	Pinch-off Voltage at $V_{DS} = 2 \text{ V}$, $I_D = 0.32\text{mA}$		-1.0*		Volts
BV_{DGO}	Drain-Gate Breakdown Voltage at $I_{DGO} = 0.08\text{mA}$	9	12		Volts
R_{th}	Thermal Resistance		250		$^\circ\text{C/W}$

ABSOLUTE MAXIMUM RATINGS ($T_A=25^\circ\text{C}$)

Symbol	Parameter	Rating
V_{DS}	Drain-Source Voltage	7.0 V
V_{GS}	Gate-Source Voltage	-3.0 V
I_{DS}	Drain Current	I_{DSS}
I_{GS}	Gate Current	160 μA
P_{in}	RF Input Power, CW	18dBm
P_T	Continuous Dissipation	150 mW
T_{CH}	Channel Temperature	175 $^\circ\text{C}$
T_{STG}	Storage Temperature	- 65 $^\circ\text{C}$ to +175 $^\circ\text{C}$

* For the tight control of the pinch-off voltage range, we divide TC2111 into 3 model numbers to fit customer design requirement

- (1) TC2111P0710 : $V_p = -0.7\text{V}$ to -1.0V
- (2) TC2111P0811 : $V_p = -0.8\text{V}$ to -1.1V
- (3) (3)TC2111P0912 : $V_p = -0.9\text{V}$ to -1.2V

If required, customer can specify the requirement in purchasing document. For special V_p requirement, please contact factory for details.

TYPICAL SCATTERING PARAMETERS (T_A=25 °C)

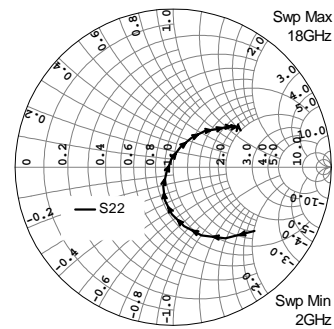
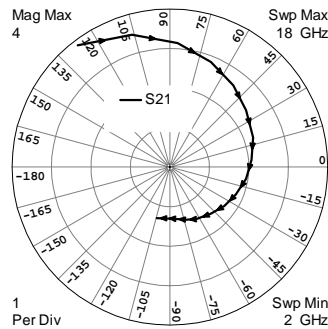
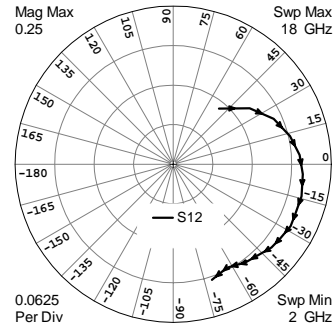
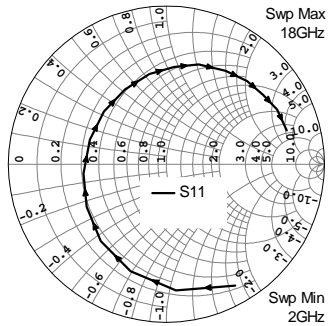
 V_{DS} = 2 V, I_{DS} = 10 mA

FREQUENCY (GHz)	S11		S21		S12		S22	
	MAG	ANG	MAG	ANG	MAG	ANG	MAG	ANG
2	0.8831	-60.46	3.8646	127.23	0.1138	50.45	0.6535	-38.12
3	0.7996	-85.63	3.4806	106.02	0.1497	36.28	0.5595	-53.71
4	0.7137	-108.57	3.1389	86.38	0.1742	24.29	0.4675	-67.28
5	0.6388	-130.49	2.8506	68.69	0.1898	13.51	0.3795	-79.69
6	0.5722	-151.76	2.6132	52.21	0.2003	4.16	0.2975	-91.49
7	0.5280	-173.62	2.4064	36.64	0.2054	-4.43	0.2159	-104.14
8	0.5085	162.27	2.2373	19.66	0.2092	-13.99	0.1376	-117.68
9	0.5167	139.70	2.0750	4.95	0.2082	-21.55	0.0554	-141.42
10	0.5395	118.98	1.9528	-8.82	0.2100	-27.76	0.0501	102.95
11	0.5796	100.67	1.8097	-22.46	0.2061	-34.71	0.1312	70.43
12	0.6165	85.53	1.6993	-35.53	0.2037	-40.38	0.2152	58.30
13	0.6627	71.98	1.5745	-48.63	0.1970	-46.78	0.3016	49.04
14	0.6985	57.54	1.4751	-63.05	0.1929	-53.79	0.3658	40.94
15	0.7331	45.81	1.3873	-73.74	0.1886	-57.56	0.4253	36.81
16	0.7528	35.70	1.3131	-84.88	0.1843	-62.47	0.4632	33.14
17	0.7809	26.29	1.3009	-94.66	0.1874	-66.39	0.4841	31.79
18	0.7904	15.74	1.3349	-104.52	0.1927	-71.48	0.4906	33.34

TYPICAL SCATTERING PARAMETERS (T_A=25 °C)

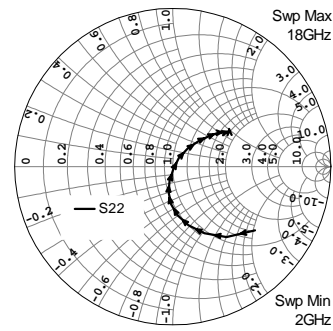
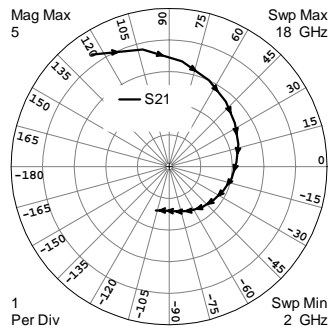
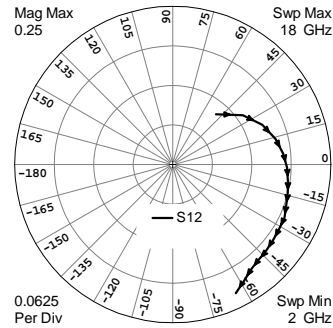
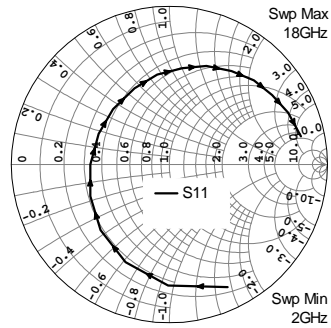
 V_{DS} = 6 V, I_{DS} = 25 mA

FREQUENCY (GHz)	S11		S21		S12		S22	
	MAG	ANG	MAG	ANG	MAG	ANG	MAG	ANG
2	0.8581	-64.49	4.3021	124.59	0.1050	49.19	0.6590	-37.77
3	0.7643	-90.63	3.7961	102.75	0.1354	35.14	0.5588	-52.54
4	0.6766	-114.16	3.3555	83.03	0.1548	23.87	0.4665	-64.64
5	0.6020	-136.38	3.0047	65.27	0.1673	13.98	0.3832	-75.06
6	0.5399	-158.14	2.7283	48.89	0.1757	5.68	0.3066	-84.59
7	0.5010	-179.90	2.4895	33.50	0.1810	-1.43	0.2338	-92.77
8	0.4873	156.56	2.3047	17.95	0.1844	-8.80	0.1626	-99.72
9	0.5006	135.50	2.1376	3.74	0.1878	-14.40	0.0930	-102.21
10	0.5290	114.55	2.0140	-10.64	0.1911	-20.23	0.0154	-74.83
11	0.5740	97.67	1.8784	-23.82	0.1957	-25.56	0.0671	54.22
12	0.6148	82.32	1.7643	-37.20	0.1968	-31.58	0.1472	50.26
13	0.6650	69.41	1.6575	-50.22	0.1985	-37.13	0.2308	44.76
14	0.7087	56.44	1.5562	-63.32	0.2014	-43.12	0.2986	40.01
15	0.7542	44.84	1.4707	-74.91	0.2029	-48.14	0.3591	36.81
16	0.7846	34.04	1.4070	-86.38	0.2065	-52.89	0.3975	33.01
17	0.8202	23.60	1.3986	-96.89	0.2151	-58.43	0.4215	31.91
18	0.8514	12.08	1.4496	-106.78	0.2265	-63.84	0.4298	33.89

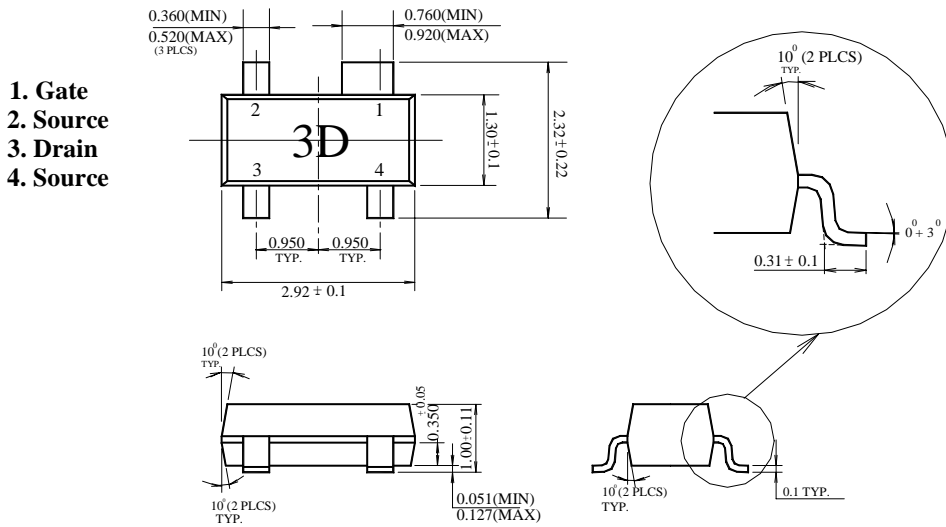
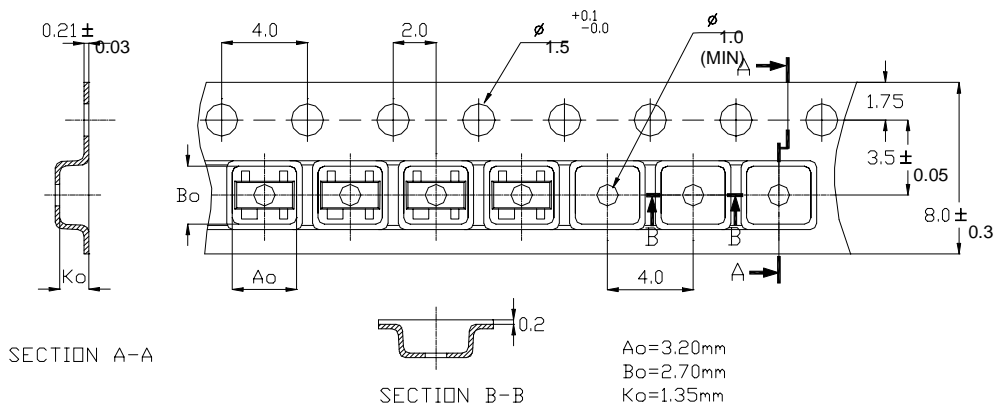
OUTLINE DIMENSIONS (in mm)

Tape & Reel Package Orientation (mm)

Standard Reel Size	7"
Standard Reel Quantity	3000