

## 3A DUAL HIGH-SPEED POWER MOSFET DRIVERS

### FEATURES

- High Peak Output Current ..... 3A
- Wide Operating Range ..... 4.5V to 18V
- High Capacitive Load Drive Capability ..... 1800pF in 25nsec
- Short Delay Times ..... <40nsec Typ.
- Matched Rise/Fall Times
- Low Supply Current
  - With Logic "1" Input ..... 3.5mA
  - With Logic "0" Input ..... 350µA
- Low Output Impedance ..... 3.5Ω Typ.
- Latch-Up Protected ..Will Withstand 1.5A Reverse Current
- Logic Input Will Withstand Negative Swing Up to 5V
- ESD Protected .....4kV
- Pinouts Same as TC1426/27/28; TC4426/27/28

### ORDERING INFORMATION

Part No.	Package	Temperature Range
TC4423COE	16-Pin SOIC (Wide)	0°C to +70°C
TC4423CPA	8-Pin Plastic DIP	0°C to +70°C
TC4423EOE	16-Pin SOIC (Wide)	- 40°C to +85°C
TC4423EPA	8-Pin Plastic DIP	- 40°C to +85°C
TC4423MJA	8-Pin CerDIP	- 55°C to +125°C
TC4424COE	16-Pin SOIC (Wide)	0°C to +70°C
TC4424CPA	8-Pin Plastic DIP	0°C to +70°C
TC4424MJA	8-Pin CerDIP	- 55°C to +125°C

### GENERAL DESCRIPTION

The TC4423/4424/4425 are higher output current versions of the new TC4426/4427/4428 buffer/drivers, which, in turn, are improved versions of the earlier TC426/427/428 series. All three families are pin-compatible. The TC4423/4424/4425 drivers are capable of giving reliable service in far more demanding electrical environments than their antecedents.

Although primarily intended for driving power MOSFETs, the TC4423/4424/4425 drivers are equally well-suited to driving any other load (capacitive, resistive, or inductive) which requires a low impedance driver capable of high peak currents and fast switching times. For example, heavily loaded clock lines, coaxial cables, or piezoelectric transducers can all be driven from the TC4423/4424/4425. The only known limitation on loading is the total power dissipated in the driver must be kept within the maximum power dissipation limits of the package.

Part No	Package	Temperature Range
TC4424EOE	16-Pin SO Wide	- 40°C to +85°C
TC4424EPA	8-Pin Plastic DIP	- 40°C to +85°C
TC4425MJA	8-Pin CerDIP	- 55°C to +125°C
TC4425COE	16-Pin SO Wide	0°C to +70°C
TC4425CPA	8-Pin Plastic DIP	0°C to +70°C
TC4425EOE	16-Pin SO Wide	- 40°C to +85°C
TC4425EPA	8-Pin Plastic DIP	- 40°C to +85°C

### FUNCTIONAL BLOCK DIAGRAM

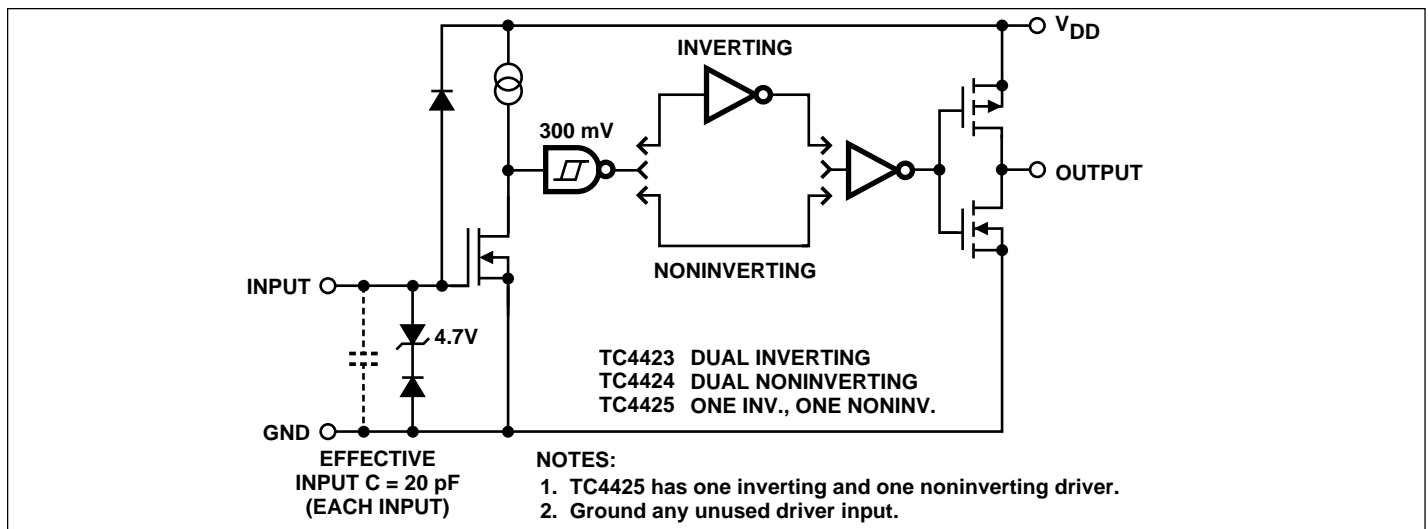

# 3A DUAL HIGH-SPEED POWER MOSFET DRIVERS

**TC4423**  
**TC4424**  
**TC4425**

## ABSOLUTE MAXIMUM RATINGS

Supply Voltage .....	+22V
Input Voltage, IN A or IN B .....	$V_{DD} + 0.3V$ to GND – 5.0V
Maximum Chip Temperature .....	+150°C
Storage Temperature Range .....	– 65°C to +150°C
Lead Temperature (Soldering, 10 sec) .....	+300°C
Package Thermal Resistance	
CerDIP $R_{\theta J-A}$ .....	150°C/W
CerDIP $R_{\theta J-C}$ .....	55°C/W
PDIP $R_{\theta J-A}$ .....	125°C/W
PDIP $R_{\theta J-C}$ .....	45°C/W

SOIC $R_{\theta J-A}$ .....	155°C/W
SOIC $R_{\theta J-C}$ .....	75°C/W
Operating Temperature Range	
C Version .....	0°C to +70°C
I Version .....	– 25°C to +85°C
E Version .....	– 40°C to +85°C
M Version .....	– 55°C to +125°C
Package Power Dissipation ( $T_A \leq 70^\circ\text{C}$ )	
Plastic DIP .....	730mW
CerDIP .....	800mW
SOIC .....	470mW

## PIN CONFIGURATIONS

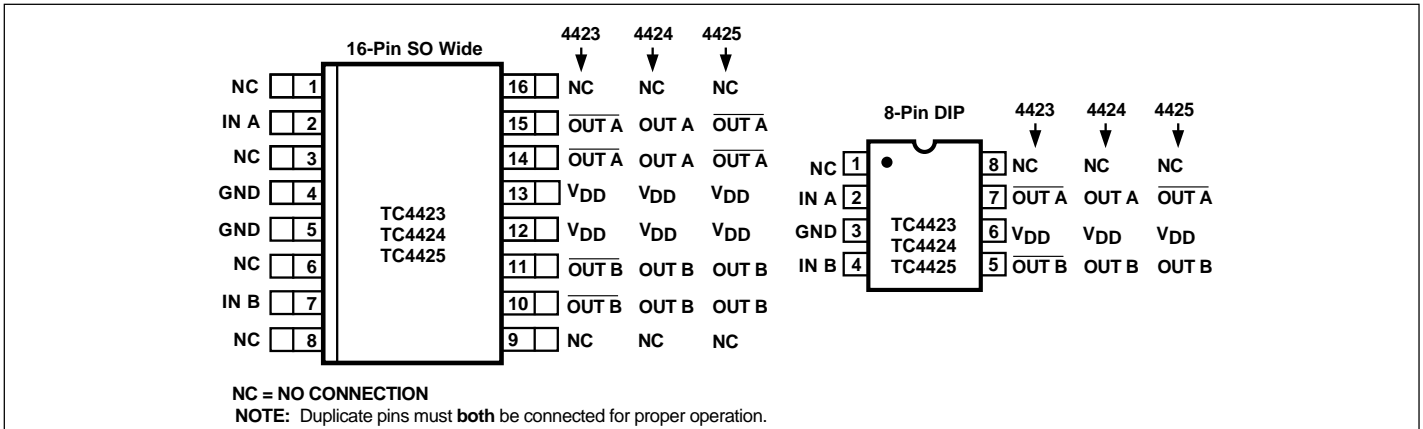

## ELECTRICAL CHARACTERISTICS: $T_A = +25^\circ\text{C}$ with $4.5V \leq V_{DD} \leq 18V$ , unless otherwise specified.

Symbol	Parameter	Test Conditions	Min	Typ	Max	Unit
<b>Input</b>						
$V_{OH}$	Logic 1 High Input Voltage		2.4	—	—	V
$V_{IL}$	Logic 0 Low Input Voltage		—	—	0.8	V
$I_{IN}$	Input Current	$0V \leq V_{IN} \leq V_{DD}$	– 1	—	1	$\mu\text{A}$
<b>Output</b>						
$V_{OH}$	High Output Voltage		$V_{DD} - 0.025$	—	—	V
$V_{OL}$	Low Output Voltage		—	—	0.025	V
$R_O$	Output Resistance, High	$I_{OUT} = 10\text{ mA}, V_{DD} = 18V$	—	2.8	5	$\Omega$
$R_O$	Output Resistance, Low	$I_{OUT} = 10\text{ mA}, V_{DD} = 18V$	—	3.5	5	$\Omega$
$I_{PK}$	Peak Output Current		—	3	—	A
$I_{REV}$	Latch-Up Protection Withstand Reverse Current	Duty Cycle $\leq 2\%$ $t \leq 300\ \mu\text{sec}$	1.5	—	—	A
<b>Switching Time (Note 1)</b>						
$t_R$	Rise Time	Figure 1, $C_L = 1800\text{pF}$	—	23	35	nsec
$t_F$	Fall Time	Figure 1, $C_L = 1800\text{pF}$	—	25	35	nsec
$t_{D1}$	Delay Time	Figure 1, $C_L = 1800\text{pF}$	—	33	75	nsec
$t_{D2}$	Delay Time	Figure 1, $C_L = 1800\text{pF}$	—	38	75	nsec
<b>Power Supply</b>						
$I_S$	Power Supply Current	$V_{IN} = 3V$ (Both Inputs) $V_{IN} = 0V$ (Both Inputs)	—	1.5 0.15	2.5 0.25	mA mA

# 3A DUAL HIGH-SPEED POWER MOSFET DRIVERS

**TC4423**  
**TC4424**  
**TC4425**

**ELECTRICAL CHARACTERISTICS (Cont.)** Over operating temperature range with  $4.5V \leq V_{DD} \leq 18V$ , unless otherwise specified.

Symbol	Parameter	Test Conditions	Min	Typ	Max	Unit
<b>Input</b>						
$V_{IH}$	Logic 1 High Input Voltage		2.4	—	—	V
$V_{IL}$	Logic 0 Low Input Voltage		—	—	0.8	V
$I_{IN}$	Input Current $0V \leq V_{IN} \leq V_{DD}$		- 10	—	10	$\mu A$
<b>Output</b>						
$V_{OH}$	High Output Voltage		$V_{DD} - 0.025$	—	—	V
$V_{OL}$	Low Output Voltage		—	—	0.025	V
$R_{O}$	Output Resistance, High	$I_{OUT} = 10\text{ mA}$ , $V_{DD} = 18V$	—	3.7	8	$\Omega$
$R_{O}$	Output Resistance, Low	$I_{OUT} = 10\text{ mA}$ , $V_{DD} = 18V$	—	4.3	8	$\Omega$
$I_{PK}$	Peak Output Current		—	3	—	A
$I_{REV}$	Latch-Up Protection Withstand Reverse Current	Duty Cycle $\leq 2\%$ $t \leq 300\ \mu\text{sec}$	1.5	—	—	A
<b>Switching Time (Note 1)</b>						
$t_R$	Rise Time	Figure 1, $C_L = 1800\text{pF}$	—	28	60	nsec
$t_F$	Fall Time	Figure 1, $C_L = 1800\text{pF}$	—	32	60	nsec
$t_{D1}$	Delay Time	Figure 1, $C_L = 1800\text{pF}$	—	32	100	nsec
$t_{D2}$	Delay Time	Figure 1, $C_L = 1800\text{pF}$	—	38	100	nsec
<b>Power Supply</b>						
$I_S$	Power Supply Current	$V_{IN} = 3V$ (Both Inputs) $V_{IN} = 0V$ (Both Inputs)	—	2	3.5	mA
			—	0.2	0.3	mA

**NOTE:** 1. Switching times guaranteed by design.

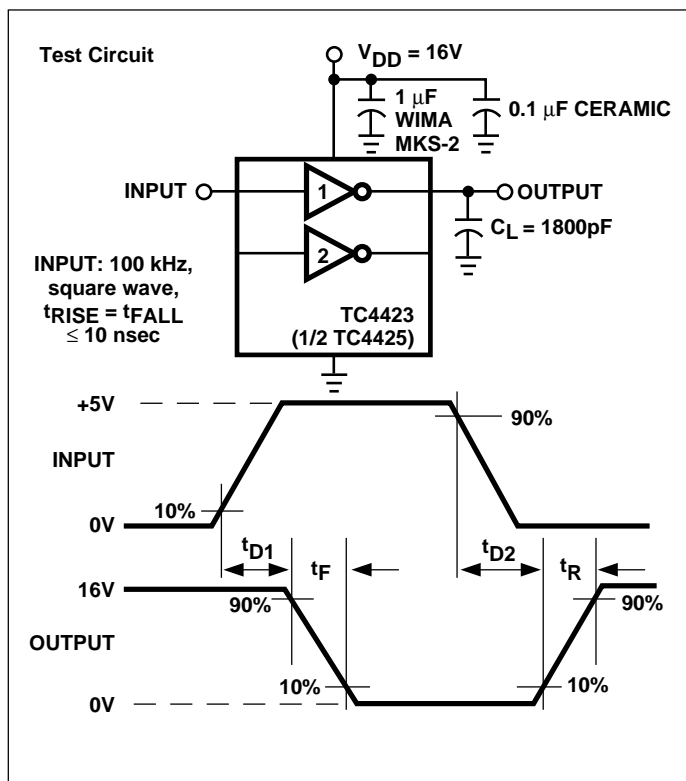

Figure 1. Inverting Driver Switching Time

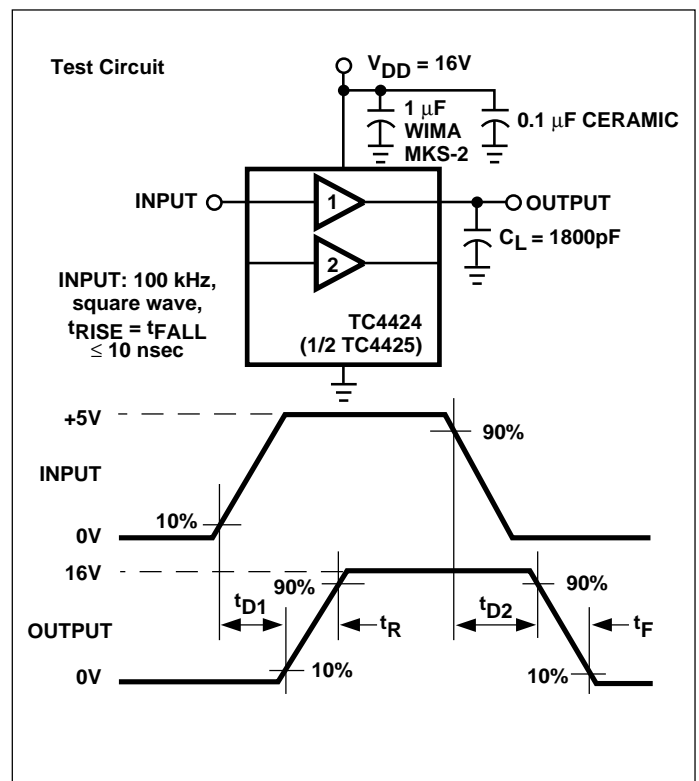
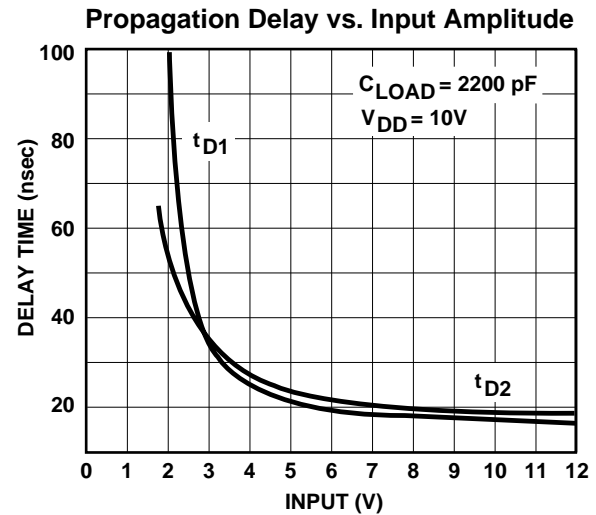
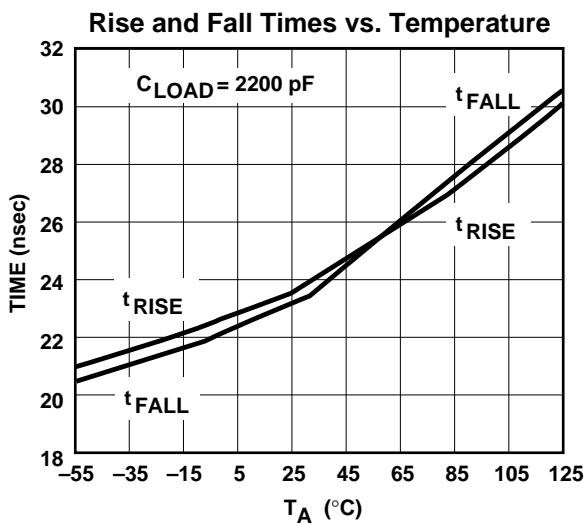
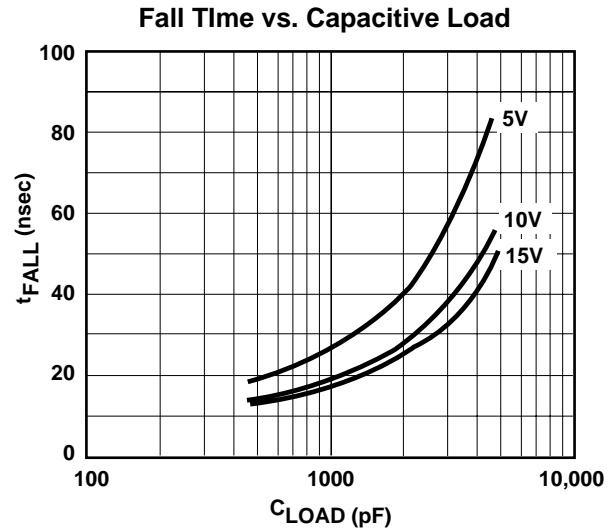
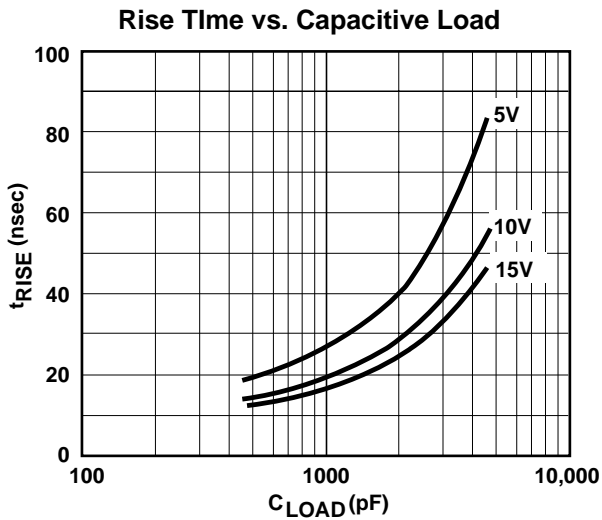
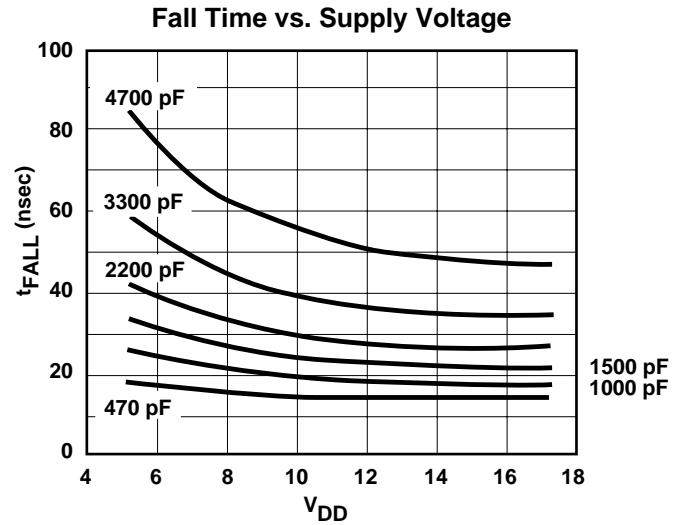
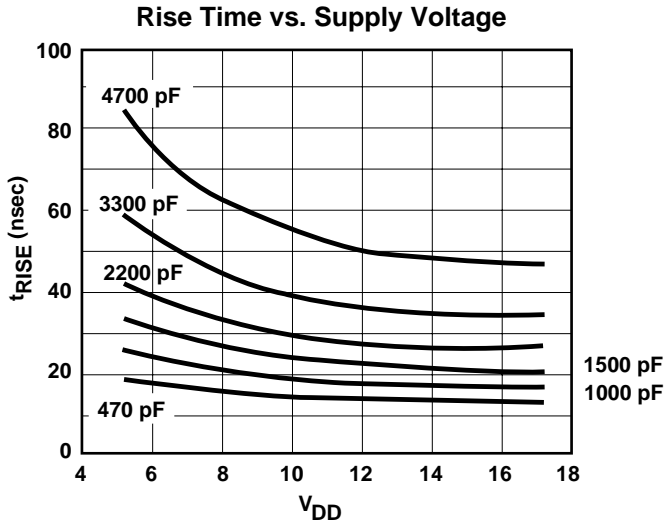

Figure 2. Noninverting Driver Switching Time

# 3A DUAL HIGH-SPEED POWER MOSFET DRIVERS

TC4423  
TC4424  
TC4425

## TYPICAL CHARACTERISTICS



# 3A DUAL HIGH-SPEED POWER MOSFET DRIVERS

TC4423  
TC4424  
TC4425

## TYPICAL CHARACTERISTICS (Cont.)

Propagation Delay Time vs. Supply Voltage

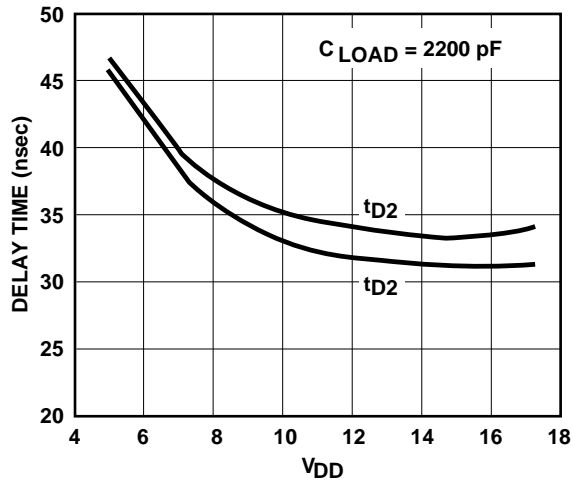

Delay Time vs. Temperature

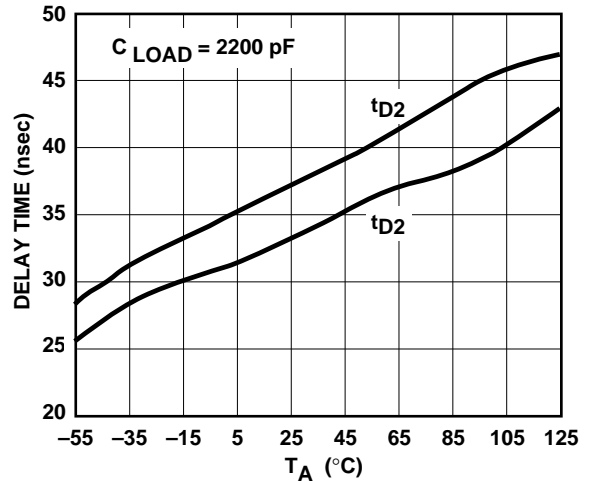

Quiescent Current vs. Supply Voltage

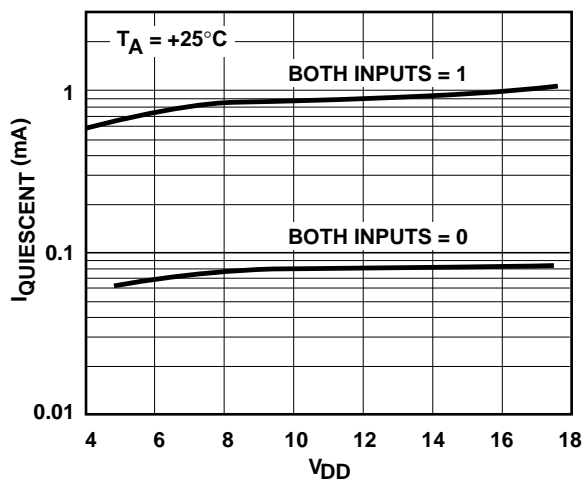

Quiescent Current vs. Temperature

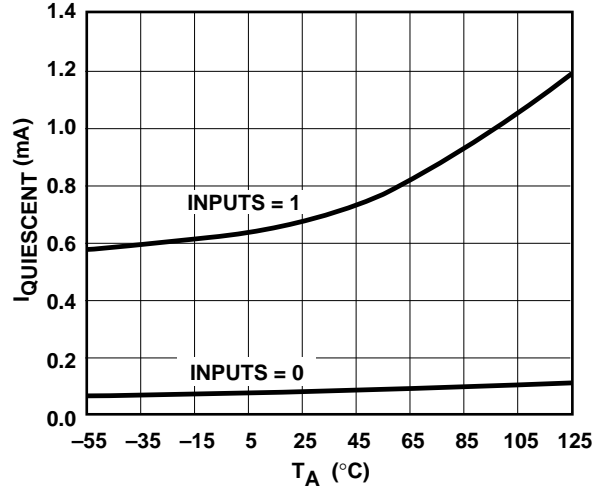

Output Resistance (Output High) vs. Supply Voltage

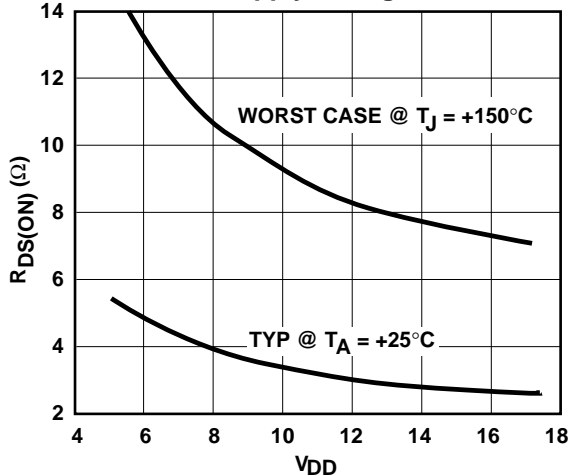

Output Resistance (Output Low) vs. Supply Voltage

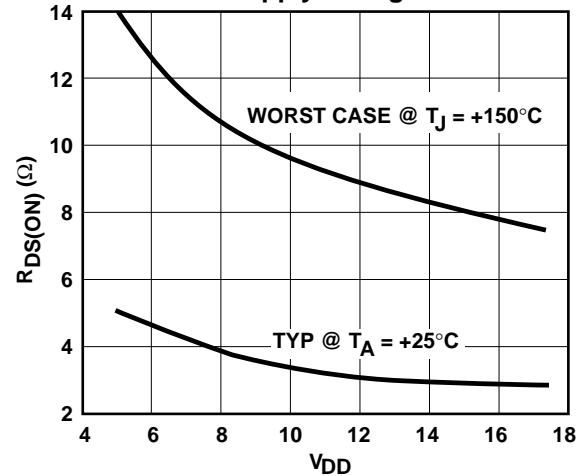

# 3A DUAL HIGH-SPEED POWER MOSFET DRIVERS

TC4423  
TC4424  
TC4425

## SUPPLY CURRENT CHARACTERISTICS (Load on Single Output Only)

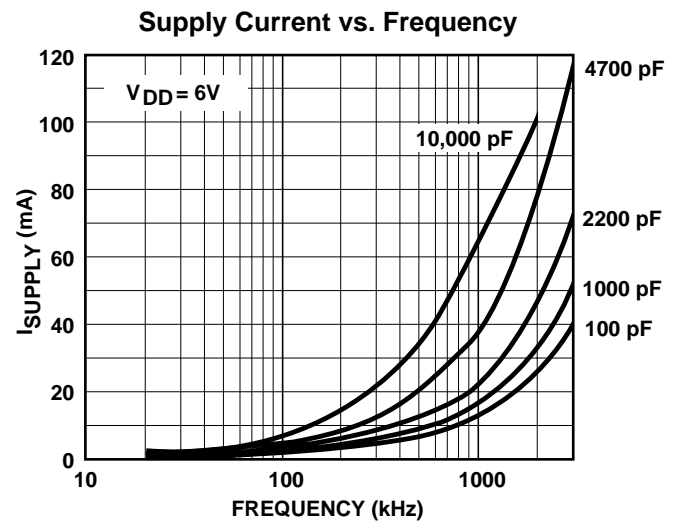
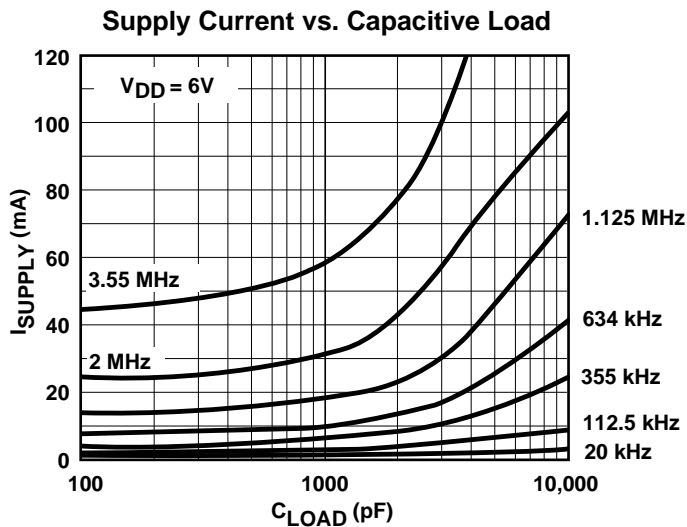
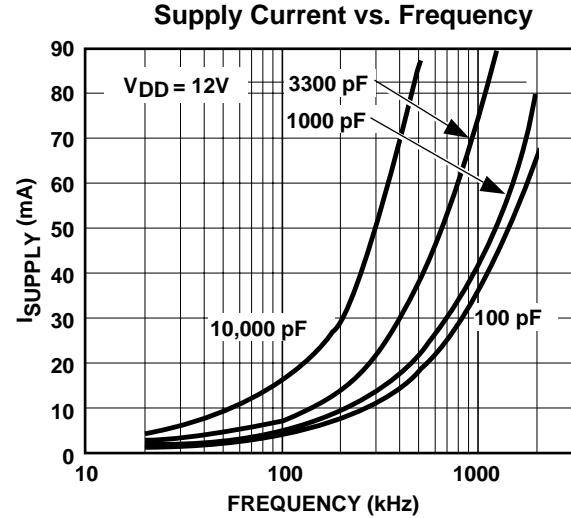
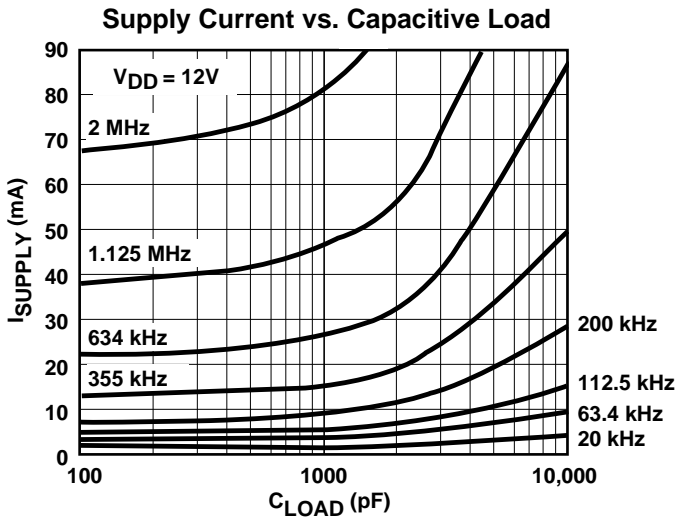
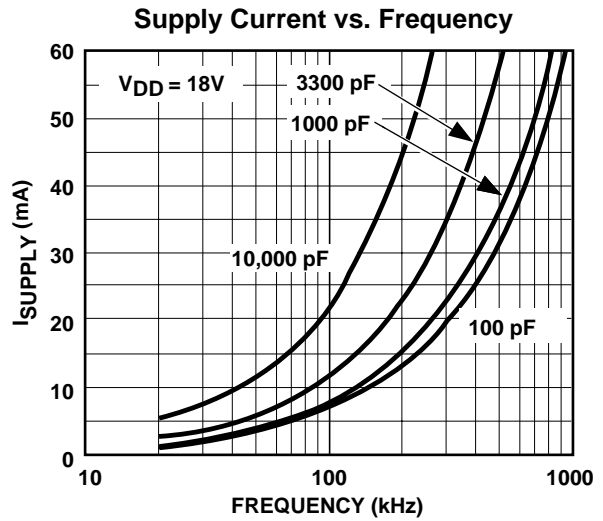
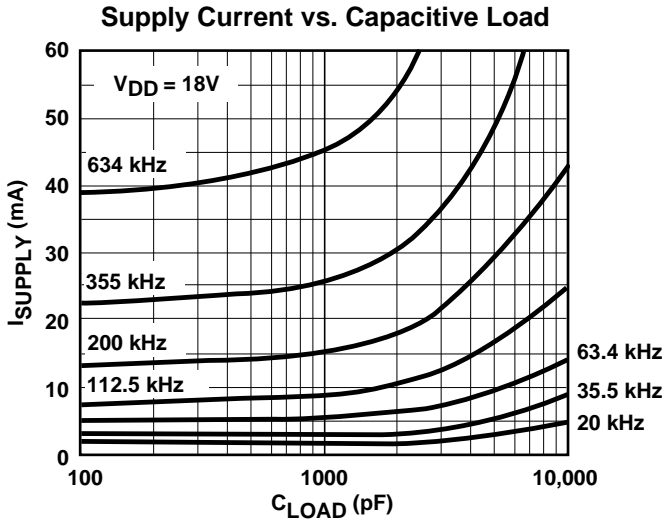

# 3A DUAL HIGH-SPEED POWER MOSFET DRIVERS

TC4423  
TC4424  
TC4425

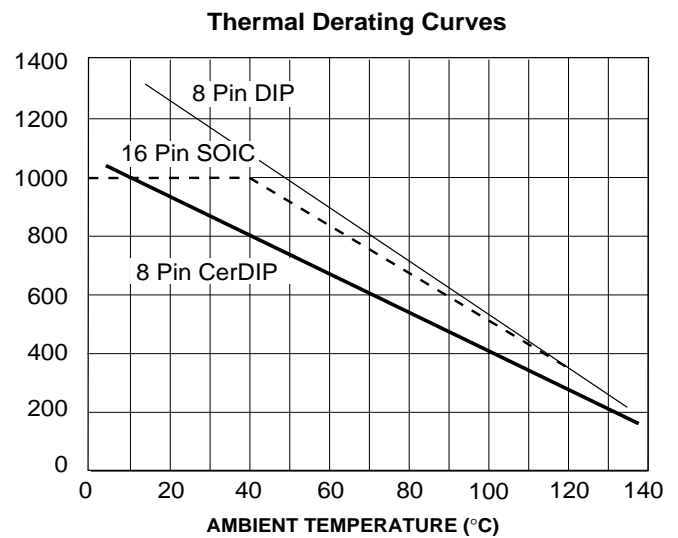
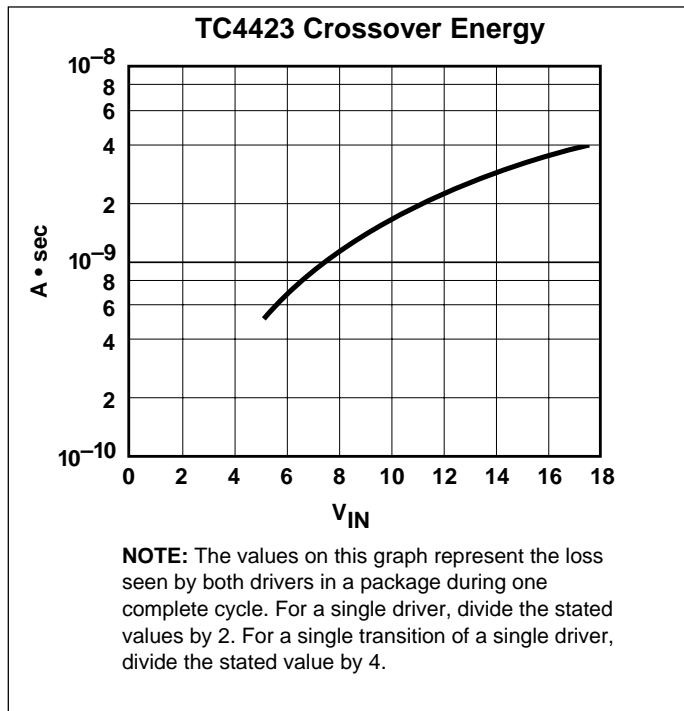

\*Static-sensitive device. Unused devices must be stored in conductive material. Protect devices from static discharge and static fields. Stresses above those listed under Absolute Maximum Ratings (See page 2) may cause permanent damage to the device. These are stress ratings only and functional operation of the device at these or any other conditions above those indicated in the operational sections of the specifications is not implied. Exposure to Absolute Maximum Rating Conditions for extended periods may affect device reliability.

## PACKAGE DIMENSIONS

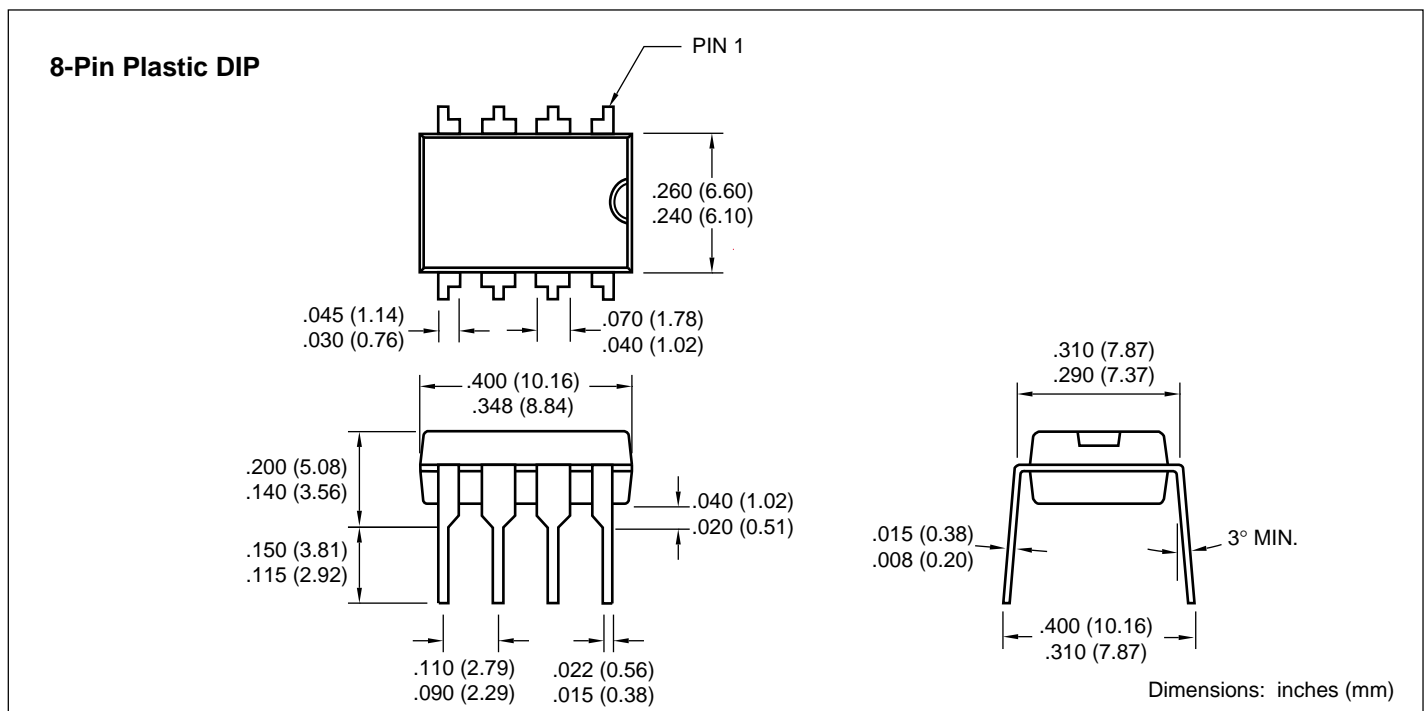

# 3A DUAL HIGH-SPEED POWER MOSFET DRIVERS

TC4423  
TC4424  
TC4425

## PACKAGE DIMENSIONS (Cont.)

### 8-Pin CerDIP

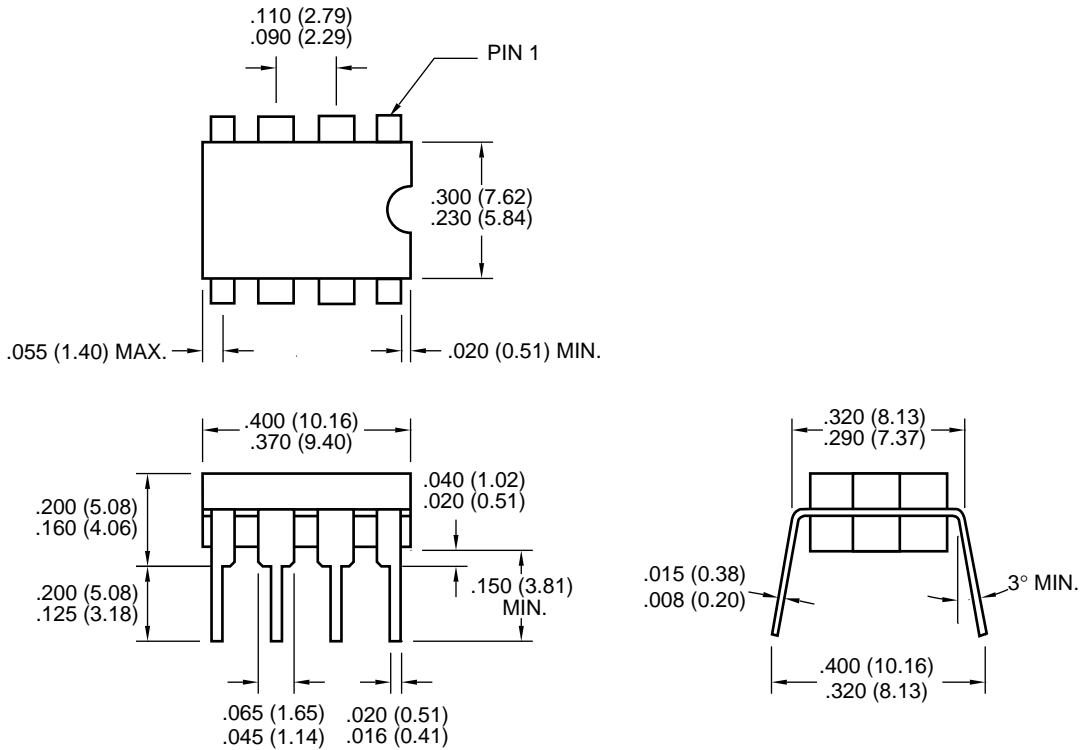

### 16-Pin Plastic SOIC (Wide)

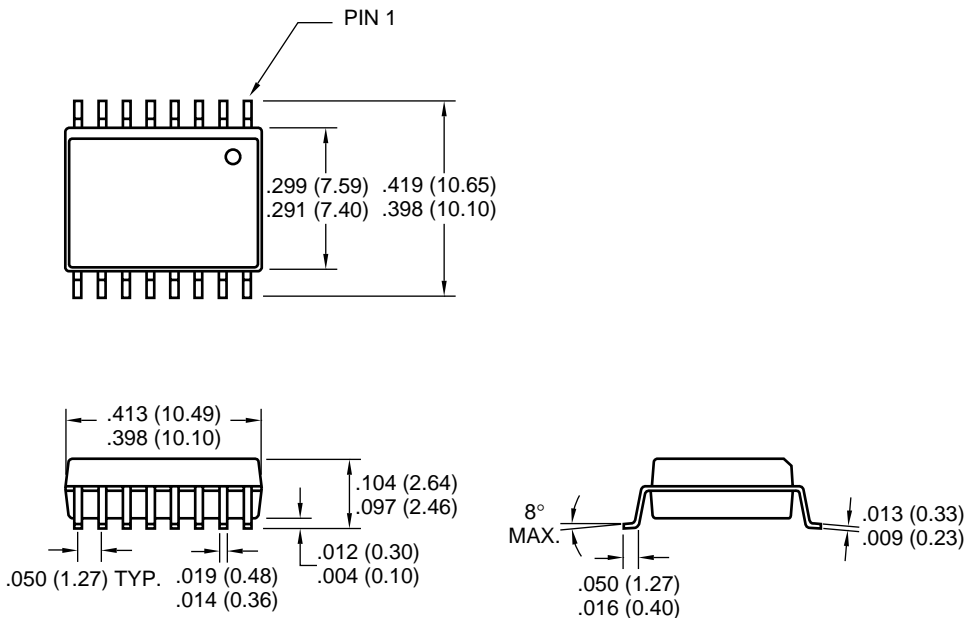

Dimensions: inches (mm)





## WORLDWIDE SALES AND SERVICE

### AMERICAS

#### Corporate Office

2355 West Chandler Blvd.  
Chandler, AZ 85224-6199  
Tel: 480-792-7200 Fax: 480-792-7277  
Technical Support: 480-792-7627  
Web Address: <http://www.microchip.com>

#### Rocky Mountain

2355 West Chandler Blvd.  
Chandler, AZ 85224-6199  
Tel: 480-792-7966 Fax: 480-792-7456

#### Atlanta

500 Sugar Mill Road, Suite 200B  
Atlanta, GA 30350  
Tel: 770-640-0034 Fax: 770-640-0307

#### Austin

Analog Product Sales  
8303 MoPac Expressway North  
Suite A-201  
Austin, TX 78759  
Tel: 512-345-2030 Fax: 512-345-6085

#### Boston

2 Lan Drive, Suite 120  
Westford, MA 01886  
Tel: 978-692-3848 Fax: 978-692-3821

#### Boston

Analog Product Sales  
Unit A-8-1 Millbrook Tarry Condominium  
97 Lowell Road  
Concord, MA 01742  
Tel: 978-371-6400 Fax: 978-371-0050

#### Chicago

333 Pierce Road, Suite 180  
Itasca, IL 60143  
Tel: 630-285-0071 Fax: 630-285-0075

#### Dallas

4570 Westgrove Drive, Suite 160  
Addison, TX 75001  
Tel: 972-818-7423 Fax: 972-818-2924

#### Dayton

Two Prestige Place, Suite 130  
Miamisburg, OH 45342  
Tel: 937-291-1654 Fax: 937-291-9175

#### Detroit

Tri-Atria Office Building  
32255 Northwestern Highway, Suite 190  
Farmington Hills, MI 48334  
Tel: 248-538-2250 Fax: 248-538-2260

#### Los Angeles

18201 Von Karman, Suite 1090  
Irvine, CA 92612  
Tel: 949-263-1888 Fax: 949-263-1338

#### Mountain View

Analog Product Sales  
1300 Terra Bella Avenue  
Mountain View, CA 94043-1836  
Tel: 650-968-9241 Fax: 650-967-1590

#### New York

150 Motor Parkway, Suite 202  
Hauppauge, NY 11788  
Tel: 631-273-5305 Fax: 631-273-5335

#### San Jose

Microchip Technology Inc.  
2107 North First Street, Suite 590  
San Jose, CA 95131  
Tel: 408-436-7950 Fax: 408-436-7955

#### Toronto

6285 Northam Drive, Suite 108  
Mississauga, Ontario L4V 1X5, Canada  
Tel: 905-673-0699 Fax: 905-673-6509

### ASIA/PACIFIC

#### China - Beijing

Microchip Technology Beijing Office  
Unit 915  
New China Hong Kong Manhattan Bldg.  
No. 6 Chaoyangmen Beidajie  
Beijing, 100027, No. China  
Tel: 86-10-85282100 Fax: 86-10-85282104

#### China - Shanghai

Microchip Technology Shanghai Office  
Room 701, Bldg. B  
Far East International Plaza  
No. 317 Xian Xia Road  
Shanghai, 200051  
Tel: 86-21-6275-5700 Fax: 86-21-6275-5060

#### Hong Kong

Microchip Asia Pacific  
RM 2101, Tower 2, Metroplaza  
223 Hing Fong Road  
Kwai Fong, N.T., Hong Kong  
Tel: 852-2401-1200 Fax: 852-2401-3431

#### India

Microchip Technology Inc.  
India Liaison Office  
Divyasree Chambers  
1 Floor, Wing A (A3/A4)  
No. 11, O'Shaughnessy Road  
Bangalore, 560 025, India  
Tel: 91-80-2290061 Fax: 91-80-2290062

#### Japan

Microchip Technology Intl. Inc.  
Benex S-1 6F  
3-18-20, Shinyokohama  
Kohoku-Ku, Yokohama-shi  
Kanagawa, 222-0033, Japan  
Tel: 81-45-471-6166 Fax: 81-45-471-6122

#### Korea

Microchip Technology Korea  
168-1, Youngbo Bldg. 3 Floor  
Samsung-Dong, Kangnam-Ku  
Seoul, Korea  
Tel: 82-2-554-7200 Fax: 82-2-558-5934

### ASIA/PACIFIC (continued)

#### Singapore

Microchip Technology Singapore Pte Ltd.  
200 Middle Road  
#07-02 Prime Centre  
Singapore, 188980  
Tel: 65-334-8870 Fax: 65-334-8850

#### Taiwan

Microchip Technology Taiwan  
11F-3, No. 207  
Tung Hua North Road  
Taipei, 105, Taiwan  
Tel: 886-2-2717-7175 Fax: 886-2-2545-0139

### EUROPE

#### Australia

Microchip Technology Australia Pty Ltd  
Suite 22, 41 Rawson Street  
Epping 2121, NSW  
Australia  
Tel: 61-2-9868-6733 Fax: 61-2-9868-6755

#### Denmark

Microchip Technology Denmark ApS  
Regus Business Centre  
Lautrup hof 1-3  
Ballerup DK-2750 Denmark  
Tel: 45 4420 9895 Fax: 45 4420 9910

#### France

Arizona Microchip Technology SARL  
Parc d'Activite du Moulin de Massy  
43 Rue du Saule Trapu  
Batiment A - 1er Etage  
91300 Massy, France  
Tel: 33-1-69-53-63-20 Fax: 33-1-69-30-90-79

#### Germany

Arizona Microchip Technology GmbH  
Gustav-Heinemann Ring 125  
D-81739 Munich, Germany  
Tel: 49-89-627-144 0 Fax: 49-89-627-144-44

#### Germany

Analog Product Sales  
Lochhamer Strasse 13  
D-82152 Martinsried, Germany  
Tel: 49-89-895650-0 Fax: 49-89-895650-22

#### Italy

Arizona Microchip Technology SRL  
Centro Direzionale Colleoni  
Palazzo Taurus 1 V. Le Colleoni 1  
20041 Agrate Brianza  
Milan, Italy  
Tel: 39-039-65791-1 Fax: 39-039-6899883

#### United Kingdom

Arizona Microchip Technology Ltd.  
505 Eskdale Road  
Winnersh Triangle  
Wokingham  
Berkshire, England RG41 5TU  
Tel: 44 118 921 5869 Fax: 44-118 921-5820

All rights reserved. © 2001 Microchip Technology Incorporated. Printed in the USA. 1/01  Printed on recycled paper.

01/09/01

Information contained in this publication regarding device applications and the like is intended through suggestion only and may be superseded by updates. It is your responsibility to ensure that your application meets with your specifications. No representation or warranty is given and no liability is assumed by Microchip Technology Incorporated with respect to the accuracy or use of such information, or infringement of patents or other intellectual property rights arising from such use or otherwise. Use of Microchip's products as critical components in life support systems is not authorized except with express written approval by Microchip. No licenses are conveyed, implicitly or otherwise, except as maybe explicitly expressed herein, under any intellectual property rights. The Microchip logo and name are registered trademarks of Microchip Technology Inc. in the U.S.A. and other countries. All rights reserved. All other trademarks mentioned herein are the property of their respective companies.