

TC9130P

T-65-05

TC9130P 4CH INDEPENDENT CYCLIC TYPE TOUCH SWITCH

TC9130P is a cyclic type flip-flop IC of which output status is reversed according to a "L" level input signal.

This switch is effective for electronization of ON/OFF type switches for audio system.

- Independent four circuits are contained in one package.
- This switch has a Schmitt trigger circuit of high input impedance and a touch switch with no erroneous operation can be configured.
- This switch is in Bi-CMOS construction employing an emitter-follower of bi-polar transistor having large current capacity as an output buffer, and LED's as well as relays can be directly driven.
- This switch has CS (chip select) function inhibiting are inputs and DIS (disable) function inhibiting output from each channel.
- Because of C-MOS construction, this switch has a broad range of operating voltage and current consumption is low.

Unit in mm

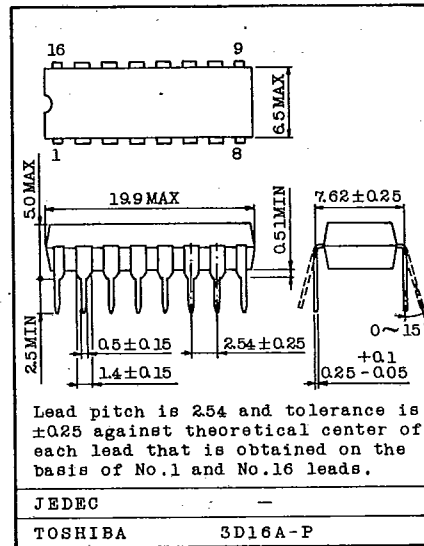

MAXIMUM RATINGS (Ta=25°C)

CHARACTERISTIC	SYMBOL	RATING	UNIT
Supply Voltage	VDD	16	V
Input Voltage	VIN	-0.3 ~ VDD+0.3	V
Output Voltage	VOUT	-0.3 ~ VDD+0.3	V
Output Current	IOUT	30	mA
Power Dissipation	Pd	600	mW
Operating Temperature	Topr	-30 ~ 75	°C
Storage Temperature	Tstg	-55 ~ 125	°C

PIN CONNECTION

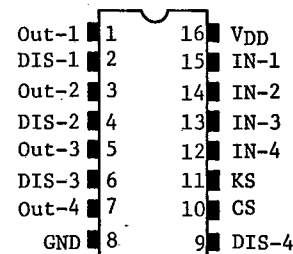

AUDIO DIGITAL IC

TC9130P

T-65-05

ELECTRICAL CHARACTERISTICS (Unless otherwise specified, $V_{DD}=12V$, $T_a=25^\circ C$)

CHARACTERISTIC	SYMBOL	TEST CIRCUIT	TEST CONDITION	MIN.	TYP.	MAX.	UNIT
Operating Supply Voltage	V_{DD}		-	3	-	16	V
Operating Supply Current	I_{DD}		$V_{DD}=16V$	-	-	20	μA
Input Current	"H" Level	I_{IH}	$V_{IH}=12V$, All input terminal	-	-	1.0	μA
	"L" Level	I_{IL}	$V_{IL}=0V$, All input terminal	-1.0	-	-	μA
Input Voltage	"H" Level	V_P	IN1 ~ 4	8.0	9.0	10.0	V
	"L" Level	V_N		5.0	6.0	7.0	V
	"H" Level	V_{IH}	CS, DIS1 ~ 4	10.5	-	-	V
	"L" Level	V_{IL}		-	-	1.5	V
Hysteretic Voltage Width	V_H		IN1 ~ 4 ($V_P - V_N$)	-	3.0	-	V
Output Current	"H" Level	I_{OH}	OUT1 ~ 4, $V_{OH}=10V$	-	-	-20	mA
	"H" Level	I_{OH}	KS $V_{OH}=9V$	-	-	-0.1	mA
	"L" Level	I_{OL}	KS $V_{OL}=1.5V$	1.0	-	-	mA

Characteristic of Output Buffer Transistor (Reference)

Characteristic of V_{DD} to I_{OH} at the time when V_{CE} is taken as parameter.

(Standard level)

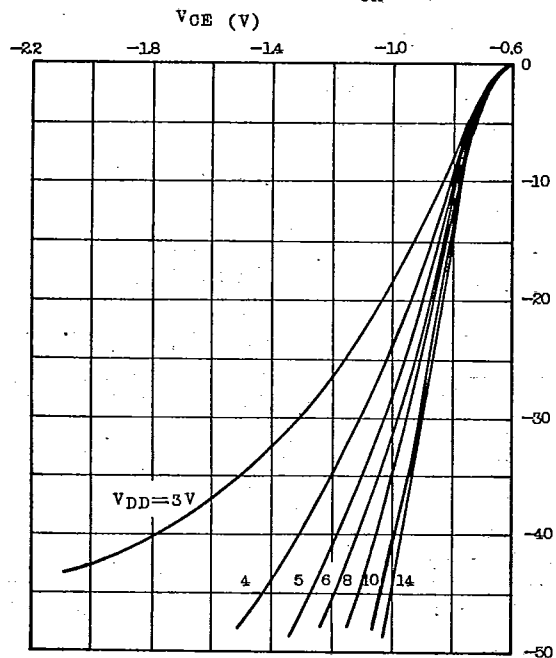

TEST CIRCUIT

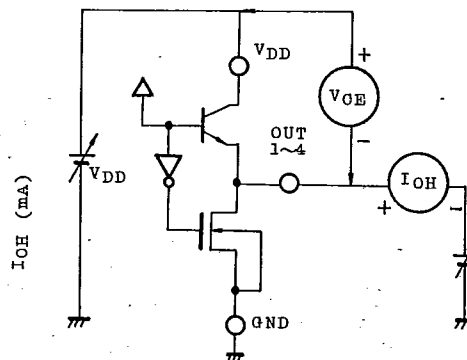

TC9130P

T-65-05

FUNCTIONAL EXPLANATION OF TERMINALS

PIN NO.	SYMBOL	TERMINAL NAME	FUNCTION
15 ? 12	IN-1 ? IN-4	Input signal terminals	When voltage applied to either one of these terminals is changed from "H" to "L" level, output from a corresponding channel is reversed. As a Schmitt trigger circuit is built in, it is possible to configure a touch switch system by connecting a touch sensor in addition to a feather-touch system by means of a mechanical key.
1 3 5 7	OUT-1 ? OUT-4	Output terminals	Whenever a corresponding input terminal is changed from "H" to "L" level, output status is reversed. The output circuit is in complementary construction of bi-polar NPN transistor and Nch FET, and when output is "H" level, max. 30mA flow out current can be obtained and it is possible to directly drive LED's for status display.
2 4 6 9	DIS-1 ? DIS-4	Output inhibiting terminals	When these terminals are set at "L" level, corresponding output terminals are fixed at "L" level regardless status of internal flip-flops. At this time, however, input signal is normally accepted.
10	CS	Input inhibiting terminal	When this terminal is set at "L" level, acceptance of all inputs to IN-1~IN-4 is inhibited and the internal flip-flops are kept in as is status
11	KS	Input detection terminal	When "L" signal is given to any one of input terminals IN-1~IN-4, this terminal becomes "L" status.
16	VDD	Power terminal	
8	GND	Earth terminal	

AUDIO DIGITAL IC

TC9130P

T-65-05

BLOCK DIAGRAM

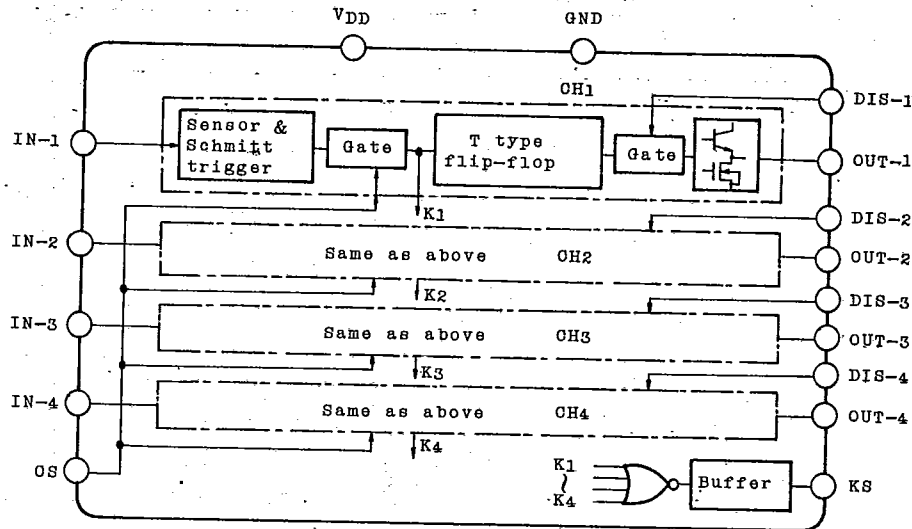

EXAMPLES OF APPLICATION CIRCUIT

1. FEATHER-TOUCH SYSTEM BY MEANS OF MECHANICAL KEY

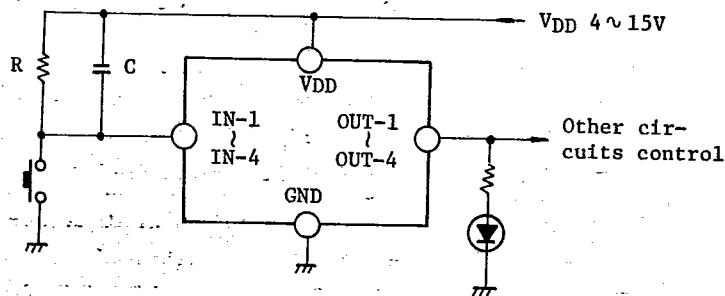

R: Pull-Up resistor

C: Chattering preventing condenser

TC9130P

T-65-05

2. TOUCH SENSOR SYSTEM THROUGH LEAK CURRENT DETECTION

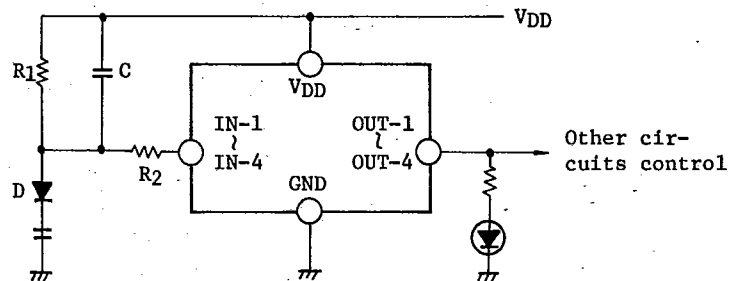

R₁ : Pull-up resistor

C : Hum wrong operation preventing condenser

D : Hum wrong operation preventing rectifier diode

R₂ : Static voltage breakage preventing protective resistor
approx. 100k Ω

* Method for deciding R₁ and C

When working supply voltage is decided, R₁ is decided from required specification for leak current detecting sensitivity, and then, C is decided so that time constant by R₁ and C is set at 50Hz or below to prevent effect by hum. When C becomes large, reset time for input acceptance (constant of C at time of discharge) becomes longer, correspondingly, and therefore, an optimum value should be decided depending upon an experiment.

3. METHOD FOR INITIALIZING AT TIME POWER IS TURNED ON

When both CS (10 pin chip select terminal) and KS (11 pin key strobe terminal) of TC9130P are simultaneously set at "L" level, the flip-flops of internal four circuits are all cleared and outputs from OUT-1 ~ OUT-4 are set at "L" level.

TC9130P

T-65-05

By utilizing this function, initialization at time of power ON can be carried out in the following circuits:

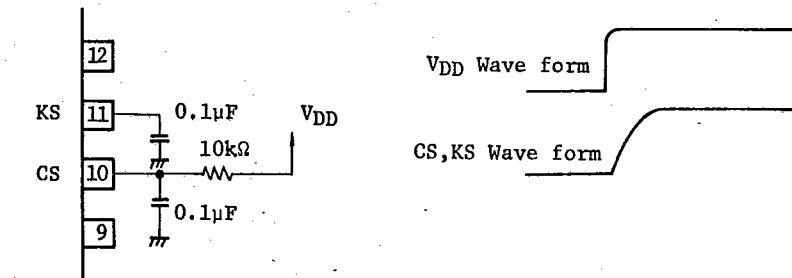

4. BACK-UP METHOD

By setting DIS-1 through DIS-4 terminals at "L" level, TC9130P is able to set all of OUT-1 through OUT-4 terminals at "L" level to suspend flow out of current while storing the internal status. Because of C-MOS construction, current consumption by IC itself is extremely less and supply voltage up to 2.0V is retained.

However, in case of holding at low voltage, care should be paid to relation with above-mentioned 3 initialization functions when power of a set is turned on again and voltage is built up.

In addition, during the holding it is considered desirable to drip CS terminal to "L" level to inhibit input.