

TOSHIBA CCD LINEAR IMAGE SENSOR CCD(Charge Coupled Device)

# TCD1304AP

The TCD1304AP is a high sensitive and low dark current 3648-elements linear image sensor. The sensor can be used for POS handscanner.

The device is consist of sensitivity CCD chip.

The TCD1304AP has electronic shutter function (ICG).

Electronic shutter function can keep always output voltage constant that vary with the intensity of lights.

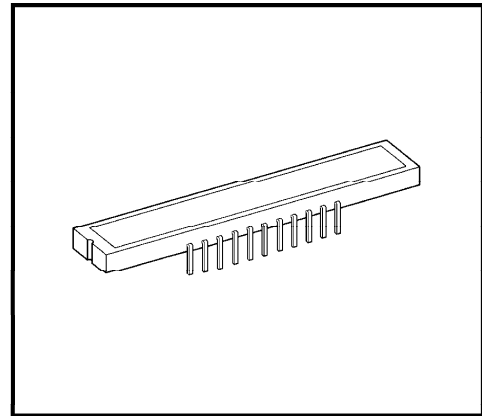

Weight : 2.7g (Typ.)

**FEATURES**

- Pixel Number : 3648
- Pixel Size : 8 $\mu$ m  $\times$  200 $\mu$ m
- Photo Sensing Region : High Sensitive & Low Dark Current pn Photodiode
- Internal Circuit : CCD Drive Circuit
- Power Supply : Only 3.0V Drive (MIN.)
- Function : Electronic Shutter  
Sample and Hold Circuit
- Package : 22 Pin DIP (T-CAPP)  
TOSHIBA-CCD-ADVANCED-PLASTIC-PACKAGE

**MAXIMUM RATINGS (Note 1)**

CHARACTERISTIC	SYMBOL	RATING	UNIT
Master Clock Pulse Voltage	V $\phi$ M	- 0.3~7	V
SH Pulse Voltage	V <sub>SH</sub>		
ICG Pulse Voltage	V <sub>ICG</sub>		
Digital Power Supply	V <sub>DD</sub>		
Analog Power Supply	V <sub>AD</sub>		
Operating Temperature	T <sub>opr</sub>	- 25~60	°C
Storage Temperature	T <sub>stg</sub>	- 40~100	°C

(Note) All voltage are with respect to SS terminals. (Ground)

**PIN CONNECTIONS**

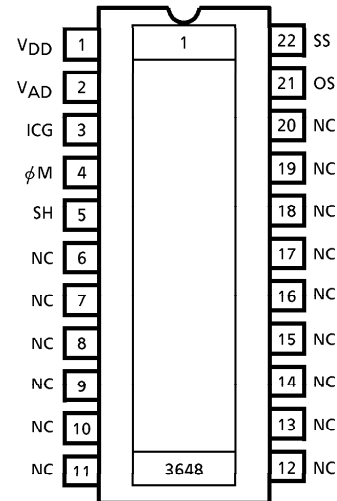

(TOP VIEW)

961001EBA2

● TOSHIBA is continually working to improve the quality and the reliability of its products. Nevertheless, semiconductor devices in general can malfunction or fail due to their inherent electrical sensitivity and vulnerability to physical stress. It is the responsibility of the buyer, when utilizing TOSHIBA products, to observe standards of safety, and to avoid situations in which a malfunction or failure of a TOSHIBA product could cause loss of human life, bodily injury or damage to property. In developing your designs, please ensure that TOSHIBA products are used within specified operating ranges as set forth in the most recent products specifications. Also, please keep in mind the precautions and conditions set forth in the TOSHIBA Semiconductor Reliability Handbook.

**CIRCUIT DIAGRAM**

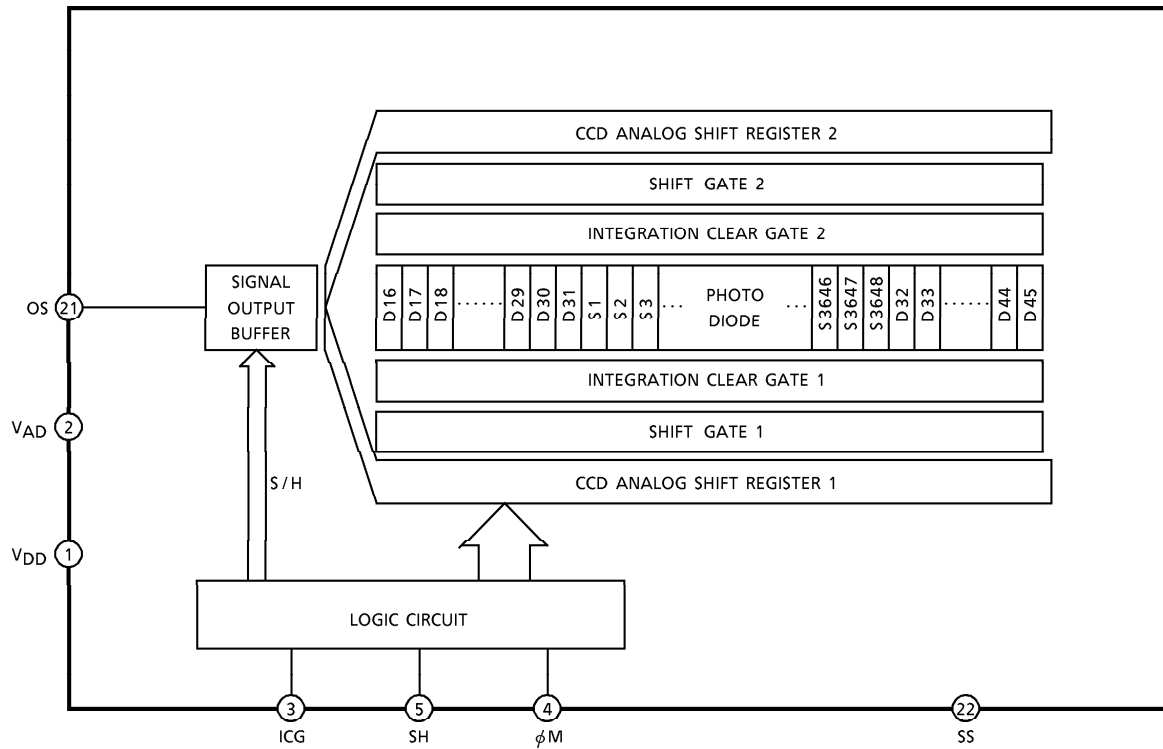

**PIN NAMES**

$\phi M$	Master Clock
SH	Shift Gate
ICG	Integration Clear Gate
VAD	Power (Analog)
VDD	Power (Digital)
SS	Ground
NC	Non Connection

961001EBA2'

● The products described in this document are subject to foreign exchange and foreign trade control laws.  
 ● The information contained herein is presented only as a guide for the applications of our products. No responsibility is assumed by TOSHIBA CORPORATION for any infringements of intellectual property or other rights of the third parties which may result from its use. No license is granted by implication or otherwise under any intellectual property or other rights of TOSHIBA CORPORATION or others.  
 ● The information contained herein is subject to change without notice.

**OPTICAL / ELECTRICAL CHARACTERISTICS**

(Ta = 25°C, V $\phi$  = 4.0V (PULSE), f $\phi$  = 0.5MHz, t $_{INT}$  (INTEGRATION TIME) = 10ms,  
LOAD RESISTANCE = 100k $\Omega$ , V $_{AD}$  = V $_{DD}$  = 4.0V, LIGHT SOURCE = DAYLIGHT FLUORESCENT LAMP)

CHARACTERISTIC	SYMBOL	MIN.	TYP.	MAX.	UNIT	NOTE
Sensitivity	R	110	160	—	V / lx·s	
Photo Response Non Uniformity	PRNU	—	—	10	%	(Note 2)
Register Imbalance	RI	—	—	3	%	(Note 3)
Saturation Output Voltage	V $_{SAT}$	450	600	—	mV	V $_{OD}$ = 3.0V (Note 4)
Dark Signal Voltage	V $_{MDK}$	—	2	5	mV	(Note 5)
Total Transfer Efficiency	TTE	92	95	—	%	
Dynamic Range	DR	—	300	—	—	(Note 6)
Saturation Exposure	SE	—	0.004	—	lx·s	(Note 7)
DC Power Dissipation	PD	—	25	75	mW	
DC Signal Output Voltage	V $_{OS}$	1.5	2.5	3.5	V	(Note 8)
Output Impedance	Z $_o$	—	0.5	1.0	k $\Omega$	
Image Lag of Electronic Shutter	VLAGICG	—	—	10	mV	T $_{int}$ = 100 $\mu$ s

(Note 2) Measured at 50% of SE (Typ.)

$$\text{Definition of PRNU: } PRNU = \frac{\Delta\bar{x}}{\bar{x}} \times 100 (\%)$$

Where  $\bar{x}$  is average of total signal outputs and  $\Delta\bar{x}$  is the maximum deviation from  $\bar{x}$  under uniform illumination.

(Note 3) Measured at 50% of SE (Typ.)

RI is defined as follows:

$$RI = \frac{\sum_{n=1}^{3647} |\chi_n - \chi_{n+1}|}{3647 \cdot \bar{x}} \times 100 (\%)$$

Where  $\chi_n$  and  $\chi_{n+1}$  are signal outputs of each pixel.  $\bar{x}$  is average of total signal outputs.

(Note 4) V $_{SAT}$  is defined as minimum saturation output voltage of all effective pixels.

(Note 5) V $_{MDK}$  is defined as maximum dark signal voltage of all effective pixels.

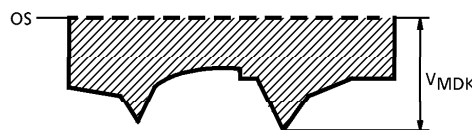

(Note 6) Definition of DR :  $DR = \frac{V_{SAT}}{V_{MDK}}$

$V_{MDK}$  is proportional to  $t_{INT}$  (Integration time).

So the shorter  $t_{INT}$  condition makes wider DR value.

(Note 7) Definition of SE :  $SE = \frac{V_{SAT}}{R} (lx \cdot s)$

(Note 8) DC signal output voltage is defined as follows:

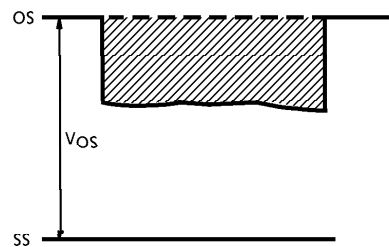

**OPERATING CONDITION**

CHARACTERISTIC		SYMBOL	MIN.	TYP.	MAX.	UNIT
Master Clock Pulse Voltage	"H" Level	$V_{\phi M}$	3.0	4.0	5.5	V
	"L" Level		0	0	0.44	
SH Pulse Voltage	"H" Level	$V_{SH}$	3.0	4.0	5.5	V
	"L" Level		0	0	0.44	
ICG Pulse Voltage	"H" Level	$V_{ICG}$	3.0	4.0	5.5	V
	"L" Level		0	0	0.44	
Digital Power Supply		$V_{DD}$	3.0	4.0	5.5	V
Analog Power Supply		$V_{AD}$	3.0	4.0	5.5	V

(Note)  $V_{AD} = V_{DD}$   
 MAX. Voltage of Pulse Voltage "H" Level =  $V_{DD}$   
 MIN. Voltage of Pulse Voltage "H" Level =  $V_{DD} - 0.5V$

**CLOCK CHARACTERISTICS (Ta = 25°C) ( $V_{AD} = V_{DD} \geq 4.0V$ )**

CHARACTERISTIC	SYMBOL	MIN.	TYP.	MAX.	UNIT
Master Clock Frequency	$f_{\phi M}$	0.8	2	4	MHz
Data Rate	$f_{DATA}$	0.2	0.5	1	MHz
Master Clock Capacitance	$C_{\phi M}$	—	10	—	pF
Shift Pulse Capacitance	$C_{SH}$	—	600	—	pF
ICG Pulse Capacitance	$C_{ICG}$	—	250	—	pF

**CLOCK CHARACTERISTICS (Ta = 25°C) ( $4.0V > V_{AD} = V_{DD} \geq 3.0V$ )**

CHARACTERISTIC	SYMBOL	MIN.	TYP.	MAX.	UNIT
Master Clock Frequency	$f_{\phi M}$	0.8	2	2.4	MHz
Data Rate	$f_{DATA}$	0.2	0.5	0.6	MHz

TIMING CHART

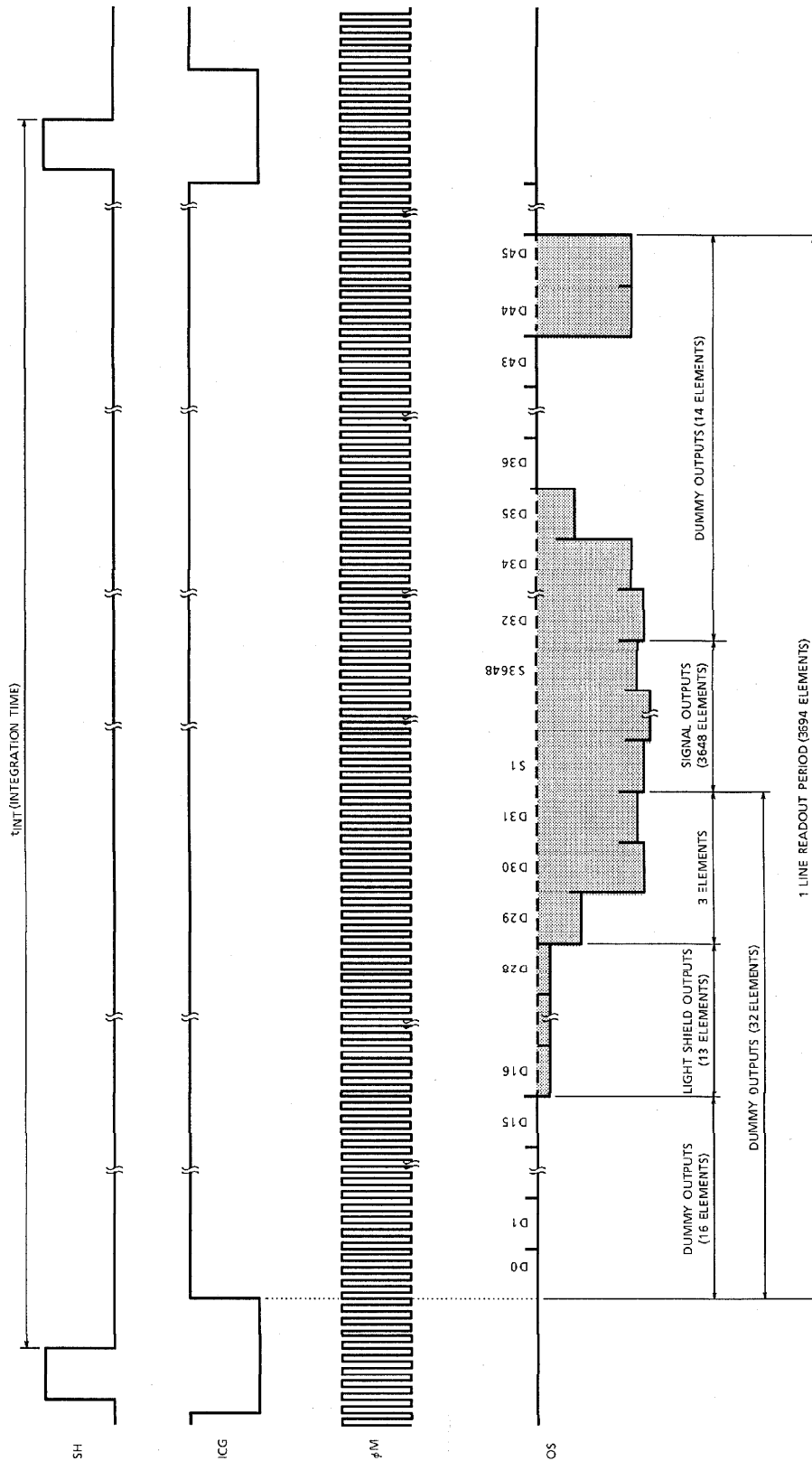

TIMING CHART (Use electric shutter function)

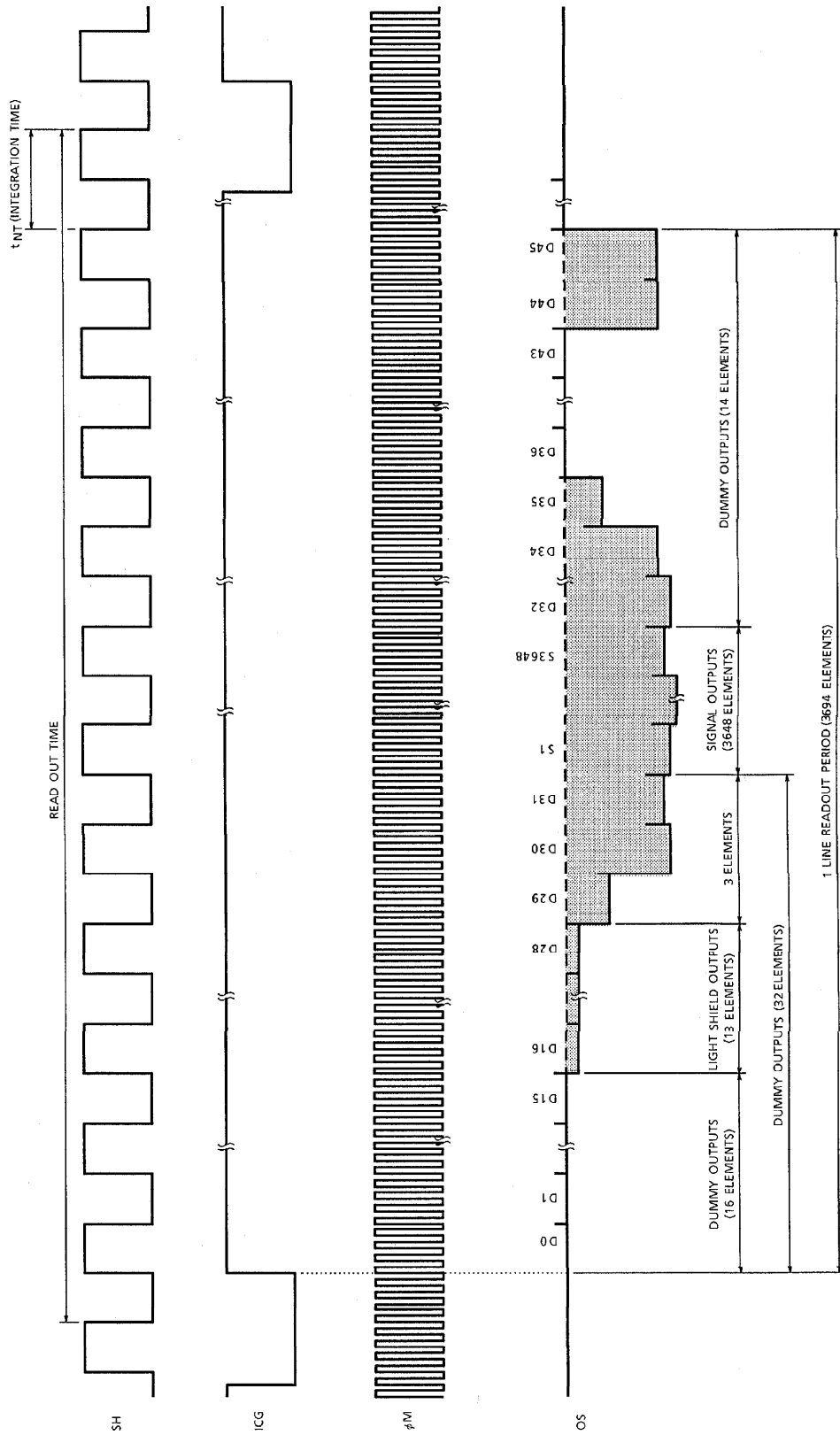

TIMING REQUIREMENTS

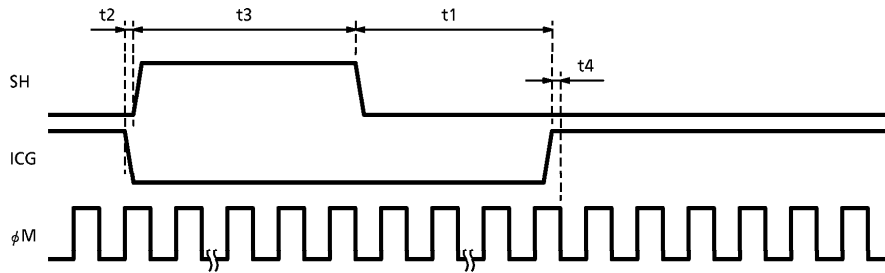

CHARACTERISTIC	SYMBOL	MIN.	TYP.	MAX.	UNIT
ICG Pulse DELAY	t1	1000	5000	—	ns
Pulse Timing of ICG and S H	t2	100	500	1000	ns
SH Pulse Width	t3	1000	—	—	ns
Pulse Timing of ICG and φ M	t4	0	20	*	ns

\* : You keep φM "High" Level.

(Note) : If you use electronic shutter function. t<sub>INT</sub> (MIN.) = 10μs



USE ELECTRONIC SHUTTER

Pulse Timing of SH and ICG

- SH cycle = Tint

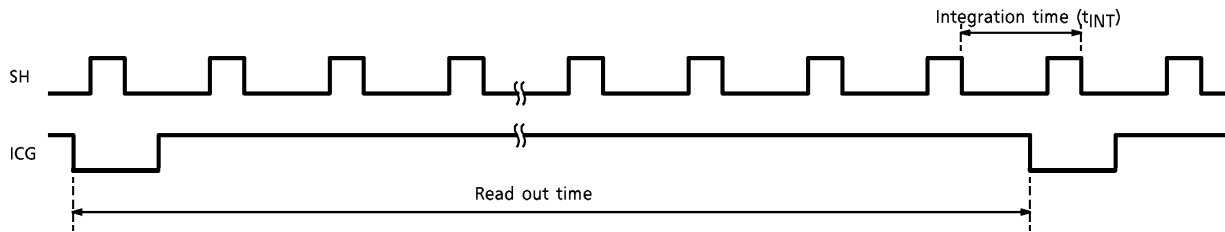

$t_{INT} (MIN.) = 10\mu s$

You have always same SH pulse width (t<sub>3</sub>).

TYPICAL PERFORMANCE CURVES

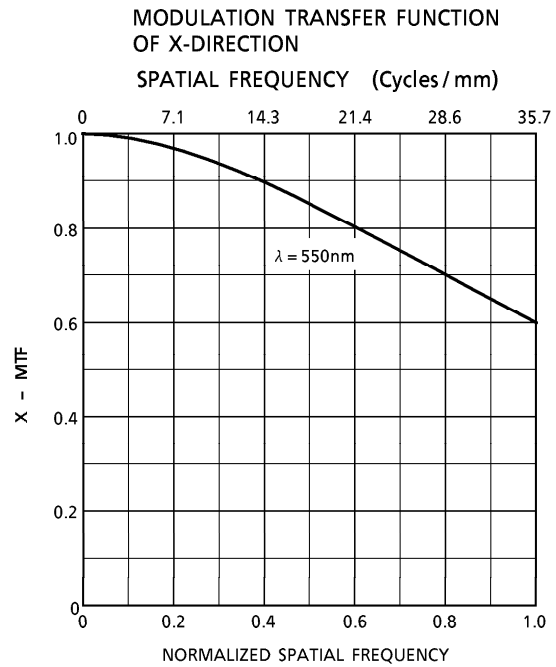
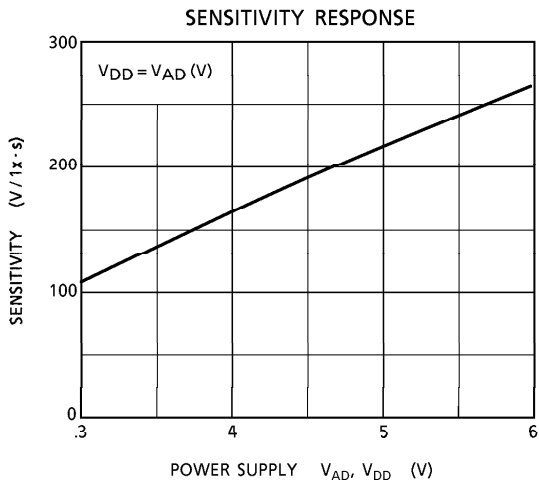
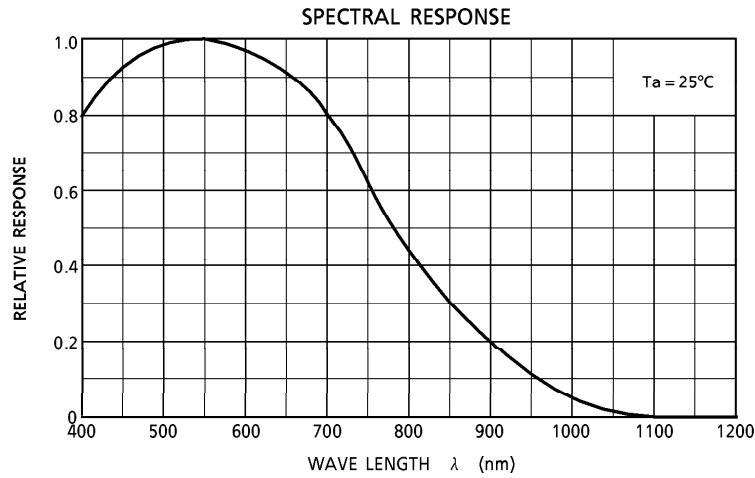

TYPICAL PERFORMANCE CURVES

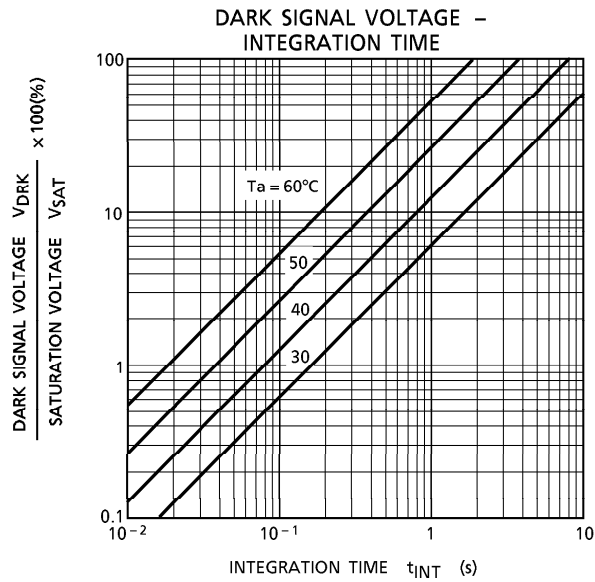
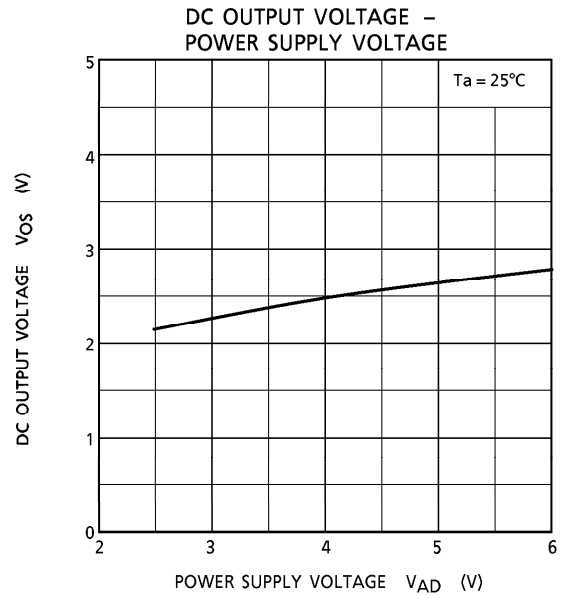
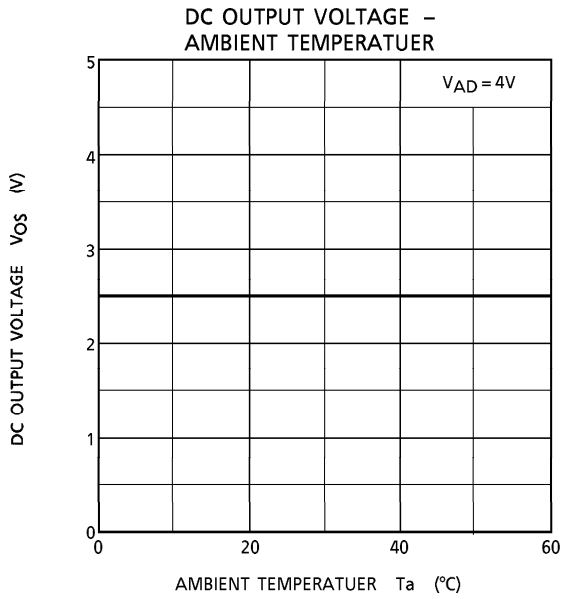

TYPICAL DRIVE CIRCUIT

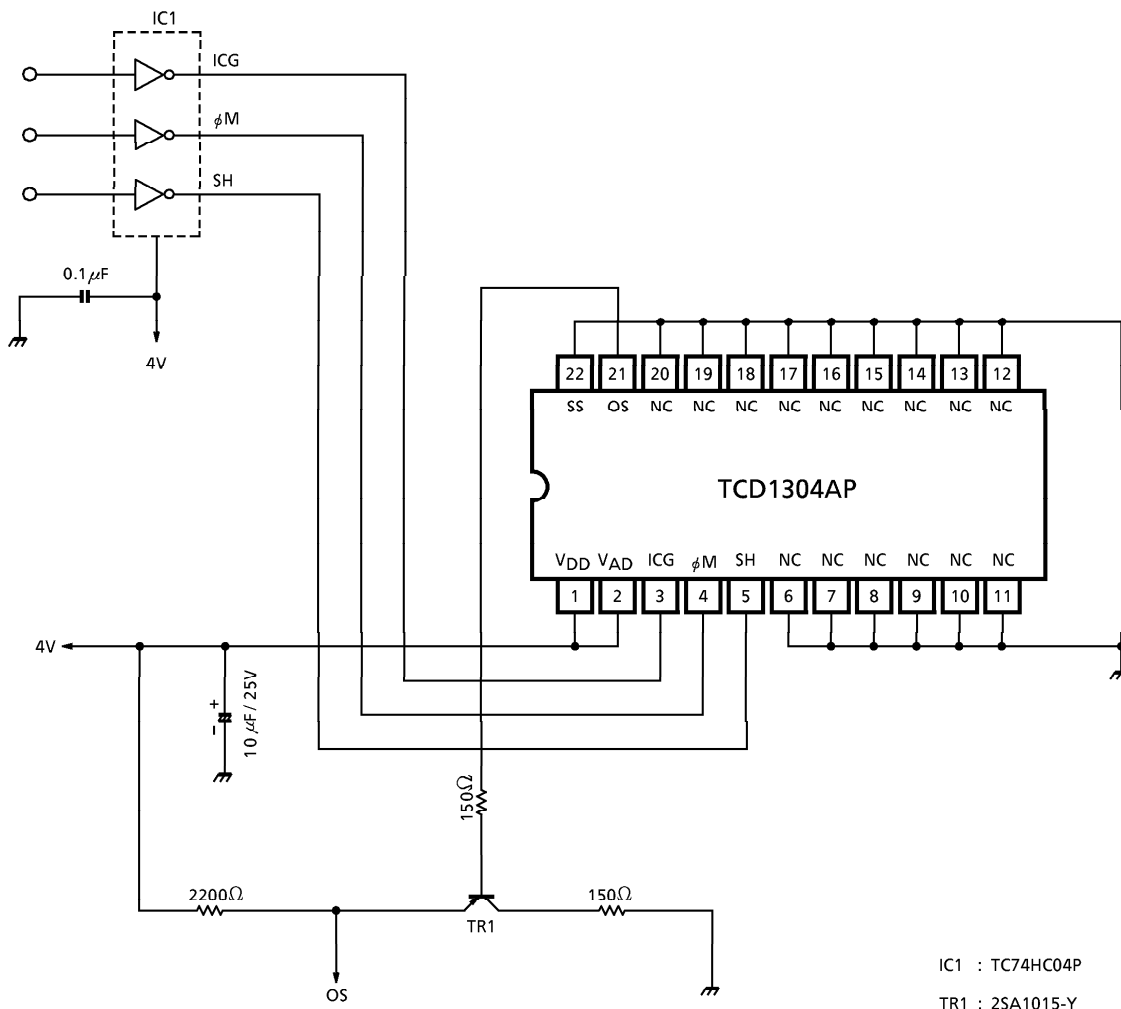

**PRECAUTIONS FOR USE OF CCD IMAGE SENSOR****1. Static Electricity**

This device has some weakly terminals for static electricity. Therefore, please pay attention to treat this device.

CCD Image Sensor is protected against static electricity, but inferior puncture mode device due to static electricity is sometimes detected. In handling the device, it is necessary to execute the following static electricity preventive measures, in order to prevent the trouble rate increase of the manufacturing system due to static electricity.

- a. Prevent the generation of static electricity due to friction by making the work with bare hands or by putting on cotton gloves and non-charging working clothes.
- b. Discharge the static electricity by providing earth plate or earth wire on the floor, door or stand of the work room.
- c. Ground the tools such as soldering iron, radio cutting plier or pincette.

It is not necessarily required to execute all precaution items for static electricity.

It is all right to mitigate the precautions by confirming that the trouble rate within the prescribed range.

**2. Window Glass**

As the dust and station on the glass window of the package will cause black flow on the picture, never fail to clean the glass surface before using. (Blow compressed vapor, and wipe off the dust, and dirt with soft cloth or paper slightly moistened with alcohol).

Fully take care for the handling of the device as the window glass will break or a strong friction is given to the window glass surface.

**3. Incident Light**

CCD sensor is sensitive to infrared light.

Note that infrared light component degrades resolution and PRNU of CCD sensor.

**4. Lead Frame Forming**

Since this package is not stout against mechanical stress, you should not reform the lead frame.

We recommend to use a IC-inserter when you assemble to PCB.

OUTLINE DRAWING

Unit : mm

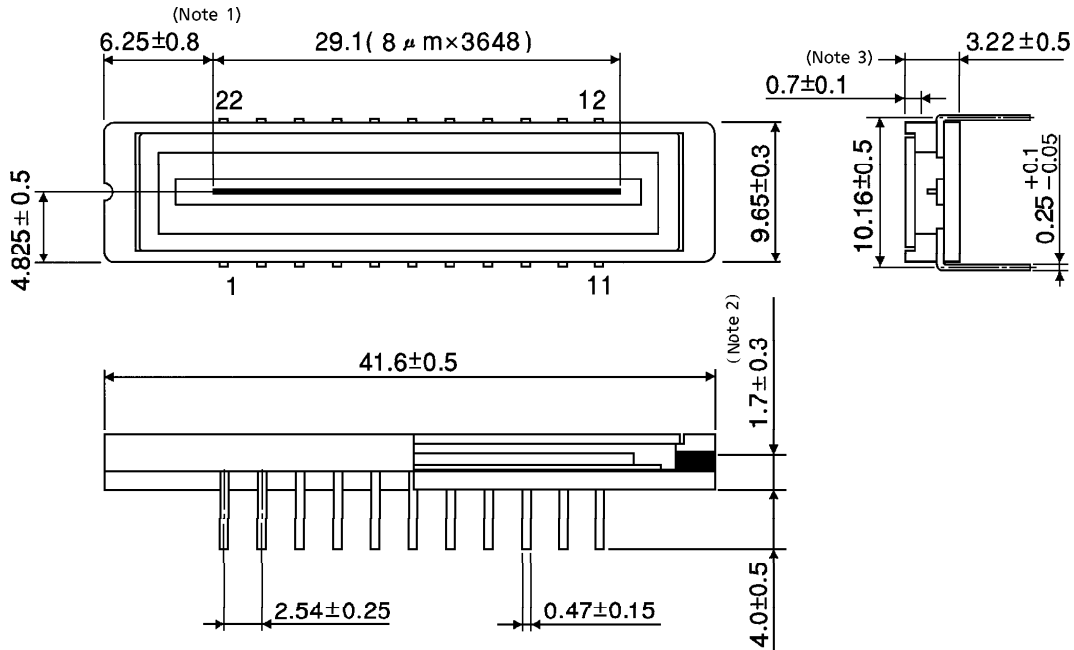

(Note 1) No. 1 SENSOR ELEMENT (S1) TO EDGE OF PACKAGE.

(Note 2) TOP OF CHIP TO BOTTOM OF PACKAGE.

(Note 3) GLASS THICKNES (n = 1.5)

Weight : 2.7g (Typ.)