



## TDA2009

## LINEAR INTEGRATED CIRCUIT

### 10 + 10W STEREO AMPLIFIER

#### DESCRIPTION

The UTC **TDA2009** is a class AB stereo audio power amplifier that contains two identical amplifiers capable of delivering 10W per channel. It is designed for quality Hi-Fi stereo application which is easy to construct and has a minimum need of external components.

#### FEATURES

- \* Supply range 8V ~ 28V
- \* High power outputs (10W/Channel)
- \* High output current up to 3.5A
- \* Short circuit protection
- \* Thermal protection

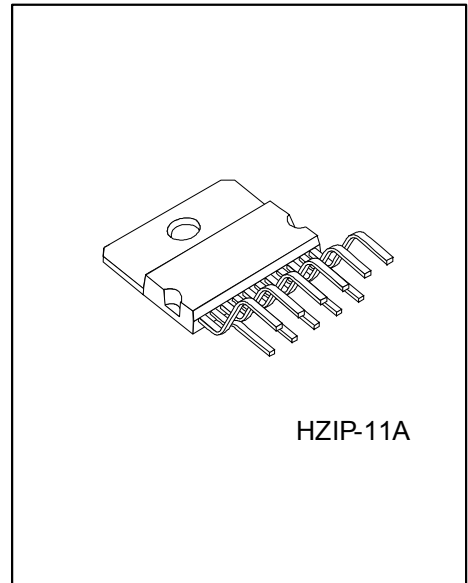

\*Pb-free plating product number: TDA2009L

#### ORDERING INFORMATION

Order Number		Package	Packing
Normal	Lead Free Plating		
TDA2009-J11-A-T	TDA2009L-J11-A-T	HZIP-11A	Tube

<p>TDA2009L-J11-A-T</p> <p>(1)Packing Type (2)Package Type (3)Lead Plating</p>	<p>(1) T: Tube (2) J11-A: HZIP-11A (3) Lead Free Plating Blank: Pb/Sn</p>
--	---

### ■ PIN CONFIGURATION

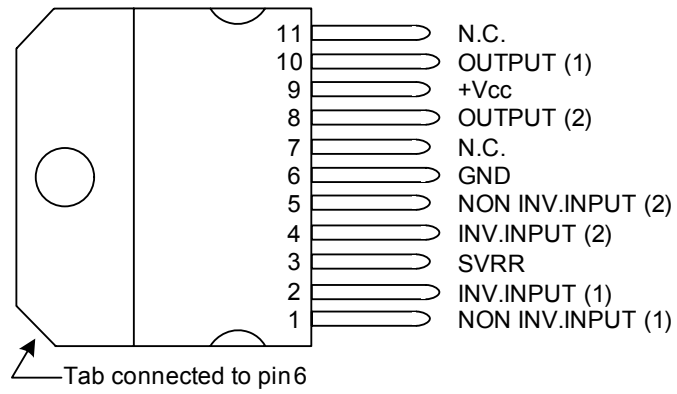

■ BLOCK DIAGRAM

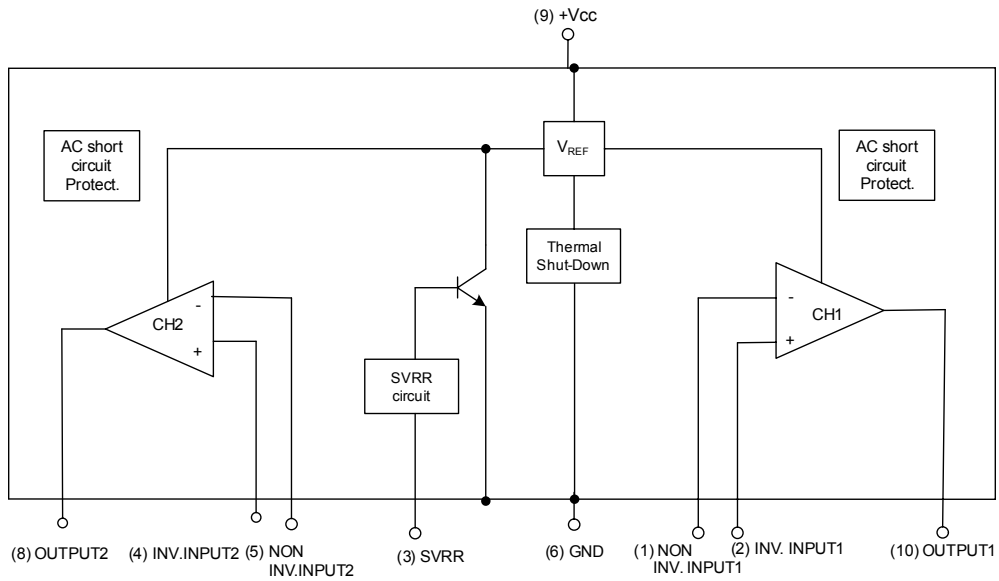

## ■ ABSOLUTE MAXIMUM RATINGS

PARAMETER		SYMBOL	RATINGS	UNIT
Supply Voltage		$V_{CC}$	28	V
Peak Output Current	repetitive, $f \geq 20\text{Hz}$	$I_{O(PEAK)}$	3.5	A
	non repetitive, $t_p=100\mu\text{s}$		4.5	A
Power Dissipation@ $T_c = 90^\circ\text{C}$		$P_D$	20	W
Junction Temperature		$T_J$	+150	$^\circ\text{C}$
Storage Temperature		$T_{STG}$	-40 ~ +150	$^\circ\text{C}$

Note Absolute maximum ratings are those values beyond which the device could be permanently damaged. Absolute maximum ratings are stress ratings only and functional device operation is not implied.

## ■ THERMAL DATA

PARAMETER	SYMBOL	RATING	UNIT
Thermal Resistance Junction to Case	$\theta_{JC}$	3.0	$^\circ\text{C/W}$

## ■ ELECTRICAL CHARACTERISTICS

(Refer to test circuit,  $T_a = 25^\circ\text{C}$ ,  $V_{CC} = 24\text{V}$ ,  $G_v = 36\text{dB}$ , unless otherwise specified)

PARAMETER		SYMBOL	TEST CONDITIONS	MIN	TYP	MAX	UNIT
Supply Voltage		$V_{CC}$		8		28	V
Quiescent Output Voltage		$V_{OUT}$	$V_{CC} = 24\text{V}$		11.5		V
Input Saturation Voltage (rms)		$V_{IN(SAT)}$		300			mV
Total Input Noise Voltage		$e_N$	$R_g = 10\text{K}\Omega$ , 22Hz~22KHz		2.5	8	$\mu\text{V}$
Total Quiescent Drain Current		$I_Q$	$V_{CC} = 24\text{V}$		60	120	mA
Output Power for each channel	$R_L = 4\Omega$	$P_{OUT}$	THD=1%, $V_{CC}=24\text{V}$ , $f=1\text{kHz}$		12.5		W
	$R_L = 8\Omega$				7		W
	$R_L = 4\Omega$		$f = 40\text{Hz} \sim 12.5\text{kHz}$	10			W
	$R_L = 8\Omega$			5			W
	$R_L = 4\Omega$		$V_{CC} = 18\text{V}$ , $f = 1\text{kHz}$		7		W
	$R_L = 8\Omega$				4		W
Total Harmonic Distortion for each channel	$R_L = 4\Omega$	THD	$P_{OUT} = 0.1 \sim 7.0\text{W}$	$f = 1\text{kHz}$ , $V_{CC}=24\text{V}$	0.2		%
	$R_L = 8\Omega$		$P_{OUT} = 0.1 \sim 3.5\text{W}$		0.1		%
	$R_L = 4\Omega$		$V_{CC}=18\text{V}$	$P_{OUT} = 0.1 \sim 5.0\text{W}$	0.2		%
	$R_L = 8\Omega$			$P_{OUT} = 0.1 \sim 2.5\text{W}$	0.1		%
Input Resistance		$R_{IN}$	$f = 1\text{kHz}$ , Non-Inverting Input	70	200		$\text{k}\Omega$
Frequency Roll off (-3dB)	Low	$f_L$	$R_L = 4\Omega$		20		Hz
	High	$f_H$	$R_L = 4\Omega$		80		kHz
Closed Loop Voltage Gain		$G_v$	$f = 1\text{kHz}$	35.5	36	36.5	dB
Closed Loop Gain Matching		$G_v$			0.5		dB
Cross Talk	$f = 1\text{kHz}$	CT	$R_L = \quad, R_g = 10\text{K}\Omega$		60		dB
	$f = 10\text{kHz}$				50		dB
Supply Voltage Rejection for each channel		SVR	$f_{RIPPLE} = 100\text{Hz}$ , $V_{RIPPLE} = 0.5\text{V}$ , $R_g = 10\text{k}\Omega$		55		dB
Thermal Shut-Down Junction Temperature					145		$^\circ\text{C}$

■ TEST AND APPLICATION CIRCUIT

( $G_v = 36\text{dB}$ )

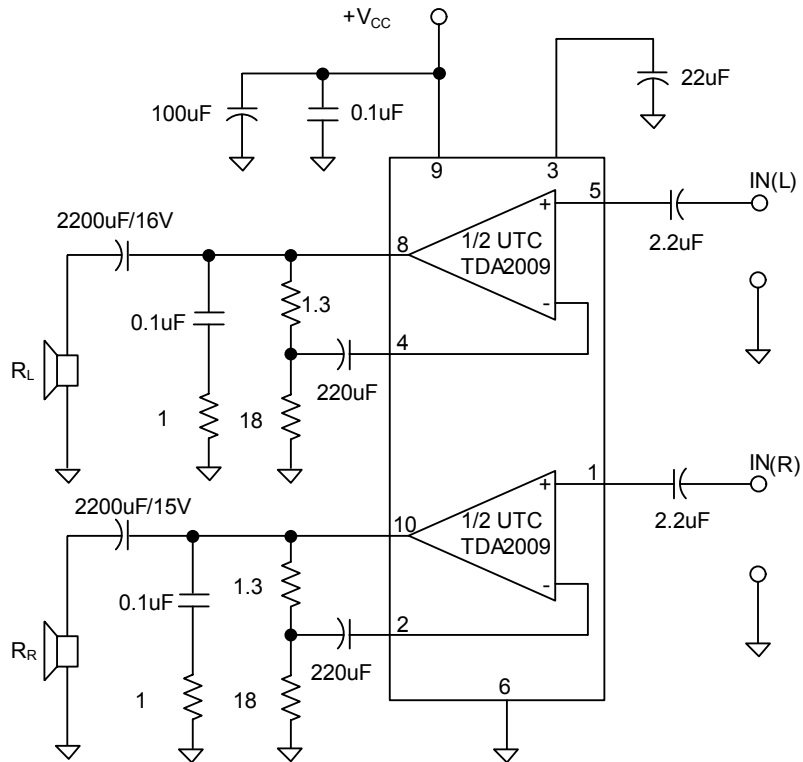

## ■ TYPICAL CHARACTERISTICS

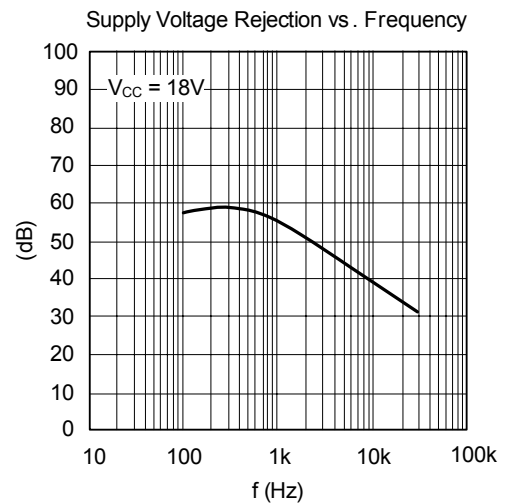
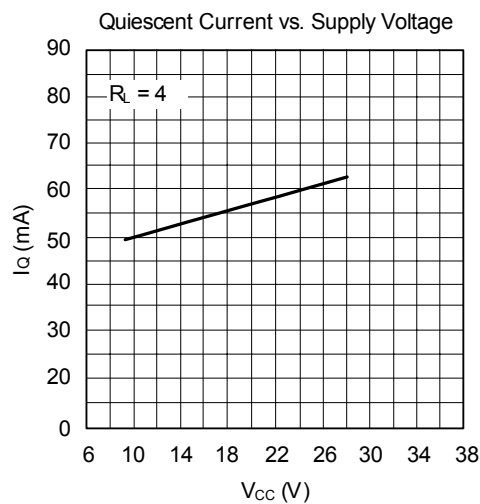
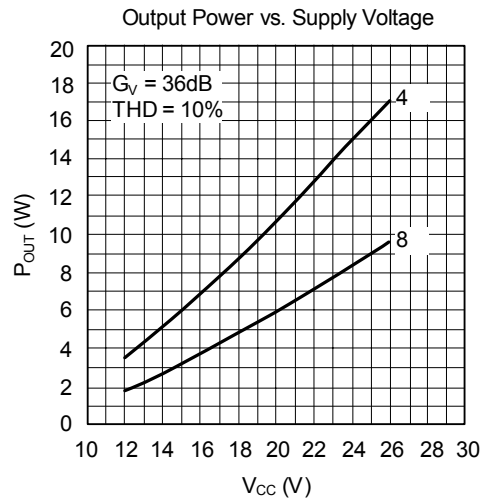
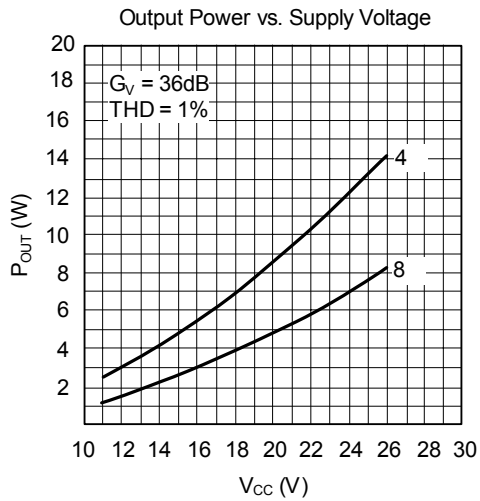

UTC assumes no responsibility for equipment failures that result from using products at values that exceed, even momentarily, rated values (such as maximum ratings, operating condition ranges, or other parameters) listed in products specifications of any and all UTC products described or contained herein. UTC products are not designed for use in life support appliances, devices or systems where malfunction of these products can be reasonably expected to result in personal injury. Reproduction in whole or in part is prohibited without the prior written consent of the copyright owner. The information presented in this document does not form part of any quotation or contract, is believed to be accurate and reliable and may be changed without notice.