

# TDA8944J

2 x 7 W stereo Bridge Tied Load (BTL) audio amplifier

Rev. 02 — 14 February 2000

Product specification

## 1. General description

The TDA8944J is a dual-channel audio power amplifier with an output power of  $2 \times 7$  W at an  $8 \Omega$  load and a 12 V supply. The circuit contains two Bridge Tied Load (BTL) amplifiers with an all-NPN output stage and standby/mute logic. The TDA8944J comes in a 17-pin DIL-bent-SIL (DBS) power package. The TDA8944J is printed-circuit board (PCB) compatible with all other types in the TDA894x family. One PCB footprint accommodates both the mono and the stereo products.

## 2. Features

- Few external components
- Fixed gain
- Standby and mute mode
- No on/off switching plops
- Low standby current
- High supply voltage ripple rejection
- Outputs short-circuit protected to ground, supply and across the load
- Thermally protected
- Printed-circuit board compatible.

## 3. Applications

- Mains fed applications (e.g. TV sound)
- PC audio
- Portable audio.

## 4. Quick reference data

Table 1: Quick reference data

Symbol	Parameter	Conditions	Min	Typ	Max	Unit
$V_{CC}$	supply voltage		6	12	18	V
$I_q$	quiescent supply current	$V_{CC} = 12$ V; $R_L = \infty$	-	24	36	mA
$I_{stb}$	standby supply current		-	-	10	$\mu$ A



Table 1: Quick reference data...continued

Symbol	Parameter	Conditions	Min	Typ	Max	Unit
$P_o$	output power	THD = 10%; $R_L = 8 \Omega$ ; $V_{CC} = 12 V$	6	7	-	W
THD	total harmonic distortion	$P_o = 1 W$	-	0.03	0.1	%
$G_v$	voltage gain		31	32	33	dB
SVRR	supply voltage ripple rejection		50	65	-	dB

### 5. Ordering information

Table 2: Ordering information

Type number	Package		Version
	Name	Description	
TDA8944J	DBS17P	plastic DIL-bent-SIL power package; 17 leads (lead length 12 mm)	SOT243-1

### 6. Block diagram

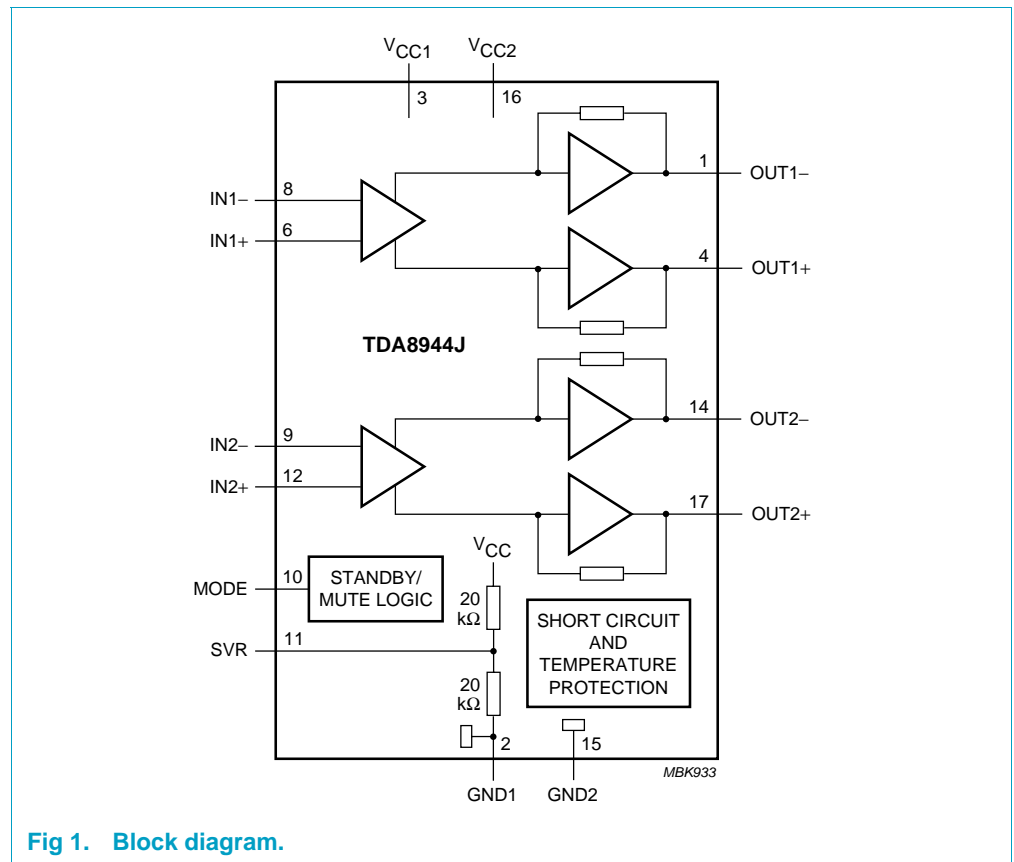

Fig 1. Block diagram.

## 7. Pinning information

### 7.1 Pinning

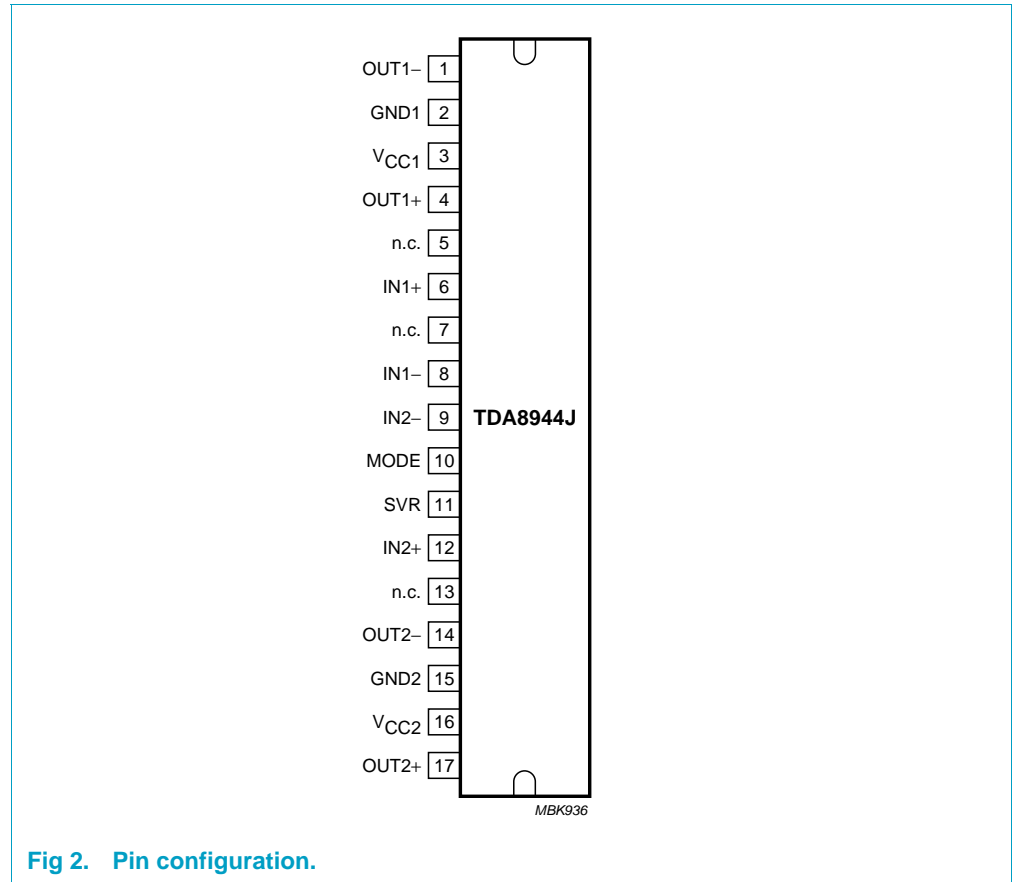

Fig 2. Pin configuration.

### 7.2 Pin description

Table 3: Pin description

Symbol	Pin	Description
OUT1-	1	negative loudspeaker terminal 1
GND1	2	ground channel 1
V <sub>CC1</sub>	3	supply voltage channel 1
OUT1+	4	positive loudspeaker terminal 1
n.c.	5	not connected
IN1+	6	positive input 1
n.c.	7	not connected
IN1-	8	negative input 1
IN2-	9	negative input 2
MODE	10	mode selection input (standby, mute, operating)
SVR	11	half supply voltage decoupling (ripple rejection)
IN2+	12	positive input 2

Table 3: Pin description...continued

Symbol	Pin	Description
n.c.	13	not connected
OUT2-	14	negative loudspeaker terminal 2
GND2	15	ground channel 2
V <sub>CC2</sub>	16	supply voltage channel 2
OUT2+	17	positive loudspeaker terminal 2

## 8. Functional description

The TDA8944J is a stereo BTL audio power amplifier capable of delivering 2 × 7 W output power to an 8 Ω load at THD = 10%, using a 12 V power supply and an external heatsink. The voltage gain is fixed at 32 dB.

With the three-level MODE input the device can be switched from ‘standby’ to ‘mute’ and to ‘operating’ mode.

The TDA8944J outputs are protected by an internal thermal shutdown protection mechanism and a short-circuit protection.

### 8.1 Input configuration

The TDA8944J inputs can be driven symmetrical (floating) as well as asymmetrical. In the asymmetrical mode one input pin is connected via a capacitor to the signal ground which should be as close as possible to the SVR (electrolytic) capacitor ground. Note that the DC level of the input pins is half of the supply voltage V<sub>CC</sub>, so coupling capacitors for both pins are necessary.

The input cut-off frequency is:

$$f_{i(cut-off)} = \frac{1}{2 - (R_i \times C_i)} \tag{1}$$

For R<sub>i</sub> = 45 kΩ and C<sub>i</sub> = 220 nF:

$$f_{i(cut-off)} = \frac{1}{2 - (45 \times 10^3 \times 220 \times 10^{-9})} = 16 \text{ Hz} \tag{2}$$

As shown in Equation 1 and 2, large capacitor values for the inputs are not necessary; so the switch-on delay during charging of the input capacitors, can be minimized. This results in a good low frequency response and good switch-on behaviour.

**Remark:** To prevent HF oscillations do not leave the inputs open, connect a capacitor of at least 1.5 nF across the input pins close to the device.

8.2 Power amplifier

The power amplifier is a Bridge Tied Load (BTL) amplifier with an all-NPN output stage, capable of delivering a peak output current of 2 A.

The BTL principle offers the following advantages:

- Lower peak value of the supply current
- The ripple frequency on the supply voltage is twice the signal frequency
- No expensive DC-blocking capacitor
- Good low frequency performance.

8.2.1 Output power measurement

The output power as a function of the supply voltage is measured on the output pins at THD = 10%; see Figure 8. The maximum output power is limited by the maximum supply voltage of 12 V and the maximum available output current: 2 A repetitive peak current.

8.2.2 Headroom

Typical CD music requires at least 12 dB (factor 15.85) dynamic headroom – compared to the average power output – for transferring the loudest parts without distortion. At  $V_{CC} = 12\text{ V}$ ,  $R_L = 8\ \Omega$  and  $P_o = 4\text{ W}$  at THD = 0.1% (see Figure 6), the Average Listening Level (ALL) – music power – without any distortion yields:

$$P_{o(ALL)} = 4\text{ W}/15.85 = 252\text{ mW}.$$

The power dissipation can be derived from Figure 11 on page 10 for 0 dB respectively 12 dB headroom.

Table 4: Power rating as function of headroom

Headroom	Power output (THD = 0.1%)	Power dissipation (P)
0 dB	$P_o = 4\text{ W}$	8 W
12 dB	$P_{o(ALL)} = 252\text{ mW}$	4 W

For the average listening level a power dissipation of 4 W can be used for a heatsink calculation.

8.3 Mode selection

The TDA8944J has three functional modes, which can be selected by applying the proper DC voltage to pin MODE. See Figure 4 and 5 for the respective DC levels, which depend on the supply voltage level. The MODE pin can be driven by a 3-state logic output stage: e.g. a microcontroller with additional components for DC-level shifting.

**Standby** — In this mode the current consumption is very low and the outputs are floating. The device is in standby mode when  $(V_{CC} - 0.5\text{ V}) < V_{MODE} < V_{CC}$ , or when the MODE pin is left floating (high impedance). The power consumption of the TDA8944J will be reduced to <0.18 mW.

**Mute** — In this mode the amplifier is DC-biased but not operational (no audio output); the DC level of the input and output pins remain on half the supply voltage. This allows the input coupling and Supply Voltage Ripple Rejection (SVRR) capacitors to be charged to avoid pop-noise. The device is in mute mode when  $3\text{ V} < V_{\text{MODE}} < (V_{\text{CC}} - 1.5\text{ V})$ .

**Operating** — In this mode the amplifier is operating normally. The operating mode is activated at  $V_{\text{MODE}} < 0.5\text{ V}$ .

### 8.3.1 Switch-on and switch-off

To avoid audible plops during supply voltage switch-on or switch-off, the device is set to standby mode before the supply voltage is applied (switch-on) or removed (switch-off).

The switch-on and switch-off time can be influenced by an RC-circuit on the MODE pin. Rapid on/off switching of the device or the MODE pin may cause 'click- and pop-noise'. This can be prevented by proper timing of the RC-circuit on the MODE pin.

## 8.4 Supply Voltage Ripple Rejection (SVRR)

The SVRR is measured with an electrolytic capacitor of 10  $\mu\text{F}$  on pin SVR at a bandwidth of 10 Hz to 80 kHz. [Figure 13 on page 11](#) illustrates the SVRR as function of the frequency. A larger capacitor value on the SVR pin improves the ripple rejection behaviour at the lower frequencies.

## 8.5 Built-in protection circuits

The TDA8944J contains two types of protection circuits, i.e. short-circuit and thermal shutdown.

### 8.5.1 Short-circuit protection

**Short-circuit to ground or supply line** — This is detected by a so-called 'missing current' detection circuit which measures the current in the positive supply line and the current in the ground line. A difference between both currents larger than 0.4 A, switches the power stage to standby mode (high impedance).

**Short-circuit across the load** — This is detected by an absolute-current measurement. An absolute-current larger than 2 A, switches the power stage to standby mode (high impedance).

### 8.5.2 Thermal shutdown protection

The junction temperature is measured by a temperature sensor; at a junction temperature of approximately 150  $^{\circ}\text{C}$  this detection circuit switches the power stage to standby mode (high impedance).

## 9. Limiting values

**Table 5: Limiting values**

In accordance with the Absolute Maximum Rating System (IEC 60134).

Symbol	Parameter	Conditions	Min	Max	Unit
V <sub>CC</sub>	supply voltage	no signal	-0.3	+25	V
		operating	-0.3	+18	V
V <sub>I</sub>	input voltage		-0.3	V <sub>CC</sub> + 0.3	V
I <sub>ORM</sub>	repetitive peak output current		-	2	A
T <sub>stg</sub>	storage temperature	non-operating	-55	+150	°C
T <sub>amb</sub>	operating ambient temperature		-40	+85	°C
P <sub>tot</sub>	total power dissipation		-	18	W
V <sub>CC(sc)</sub>	supply voltage to guarantee short-circuit protection		-	15	V

## 10. Thermal characteristics

**Table 6: Thermal characteristics**

Symbol	Parameter	Conditions	Value	Unit
R <sub>th(j-a)</sub>	thermal resistance from junction to ambient	in free air	40	K/W
R <sub>th(j-mb)</sub>	thermal resistance from junction to mounting base	both channels driven	6.9	K/W

## 11. Static characteristics

**Table 7: Static characteristics**

V<sub>CC</sub> = 12 V; T<sub>amb</sub> = 25 °C; R<sub>L</sub> = 8 Ω; V<sub>MODE</sub> = 0 V; V<sub>I</sub> = 0 V; measured in test circuit [Figure 14](#); unless otherwise specified.

Symbol	Parameter	Conditions	Min	Typ	Max	Unit
V <sub>CC</sub>	supply voltage	operating	6	12	18	V
I <sub>q</sub>	quiescent supply current	R <sub>L</sub> = ∞	[1] -	24	36	mA
I <sub>stb</sub>	standby supply current	V <sub>MODE</sub> = V <sub>CC</sub>	-	-	10	μA
V <sub>O</sub>	DC output voltage	[2] -	-	6	-	V
ΔV <sub>OUT</sub> [3]	differential output voltage offset		-	-	200	mV
V <sub>MODE</sub>	mode selection input voltage	operating mode	0	-	0.5	V
		mute mode	3	-	V <sub>CC</sub> - 1.5	V
		standby mode	V <sub>CC</sub> - 0.5	-	V <sub>CC</sub>	V
I <sub>MODE</sub>	mode selection input current	0 < V <sub>MODE</sub> < V <sub>CC</sub>	-	-	20	μA

[1] With a load connected at the outputs the quiescent current will increase, the maximum of this increase being equal to the differential output voltage offset (ΔV<sub>OUT</sub>) divided by the load resistance (R<sub>L</sub>).

[2] The DC output voltage with respect to ground is approximately 0.5V<sub>CC</sub>.

[3] ΔV<sub>OUT</sub> = |V<sub>OUT+</sub> - V<sub>OUT-</sub>|

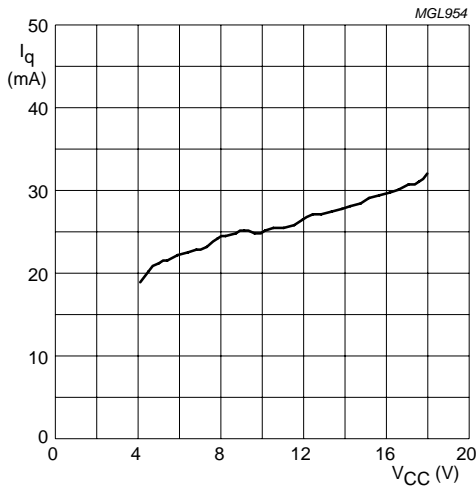

Fig 3. Quiescent current as function of supply voltage.

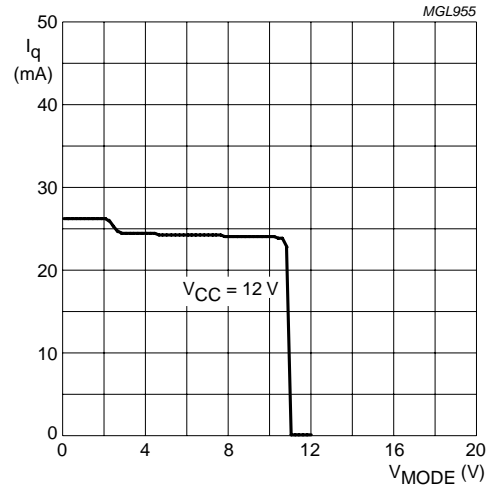

Fig 4. Quiescent current as function of mode voltage.

## 12. Dynamic characteristics

Table 8: Dynamic characteristics

V<sub>CC</sub> = 12 V; T<sub>amb</sub> = 25 °C; R<sub>L</sub> = 8 Ω; f = 1 kHz; V<sub>MODE</sub> = 0 V; measured in test circuit Figure 14; audio pass band 22 Hz to 22 kHz; unless otherwise specified.

Symbol	Parameter	Conditions	Min	Typ	Max	Unit
P <sub>o</sub>	output power	THD = 10%	6	7	-	W
		THD = 0.5%	4	5	-	W
THD	total harmonic distortion	P <sub>o</sub> = 1 W	-	0.03	0.1	%
G <sub>v</sub>	voltage gain		31	32	33	dB
Z <sub>i(dif)</sub>	differential input impedance		70	90	110	kΩ
V <sub>n(o)</sub>	noise output voltage		[1] -	90	120	μV
SVRR	supply voltage ripple rejection	f <sub>ripple</sub> = 1 kHz	[2] 50	65	-	dB
		f <sub>ripple</sub> = 100 Hz to 20 kHz	[2] -	60	-	dB
V <sub>o(mute)</sub>	output voltage	mute mode	[3] -	-	50	μV
α <sub>cs</sub>	channel separation	R <sub>s</sub> = 0 Ω	50	75	-	dB

- [1] The noise output voltage is measured at the output in a frequency range from 20 Hz to 20 kHz (unweighted), with a source impedance R<sub>s</sub> = 0 Ω at the input.
- [2] Supply voltage ripple rejection is measured at the output, with a source impedance R<sub>s</sub> = 0 Ω at the input. The ripple voltage is a sine wave with a frequency f<sub>ripple</sub> and an amplitude of 707 mV (RMS), which is applied to the positive supply rail.
- [3] Output voltage in mute mode is measured with an input voltage of 1 V (RMS) in a bandwidth of 20 kHz, so including noise.



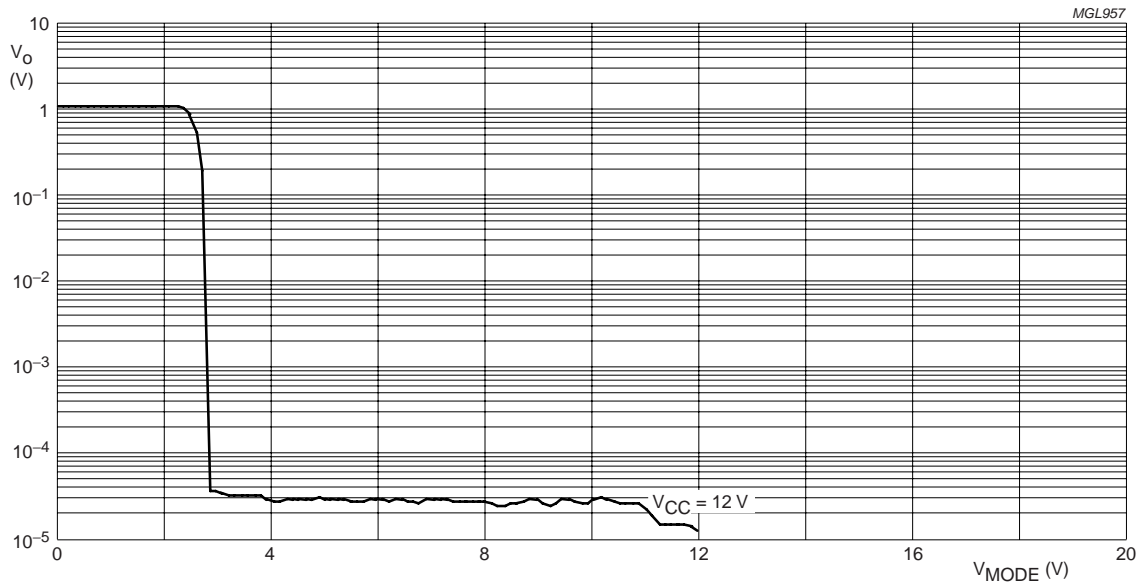

Fig 5. Output voltage as function of mode voltage.

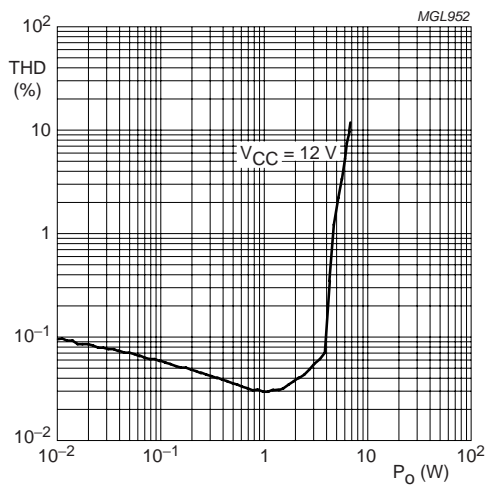
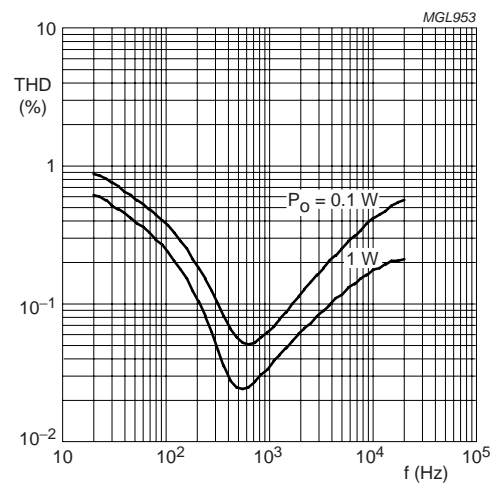
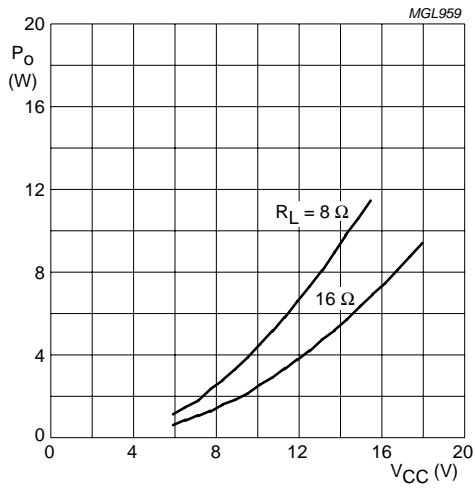

Fig 6. Total harmonic distortion as function of output power.



No bandpass filter applied.

Fig 7. Total harmonic distortion as function of frequency.



THD = 10%.

Fig 8. Output power as function of supply voltage.

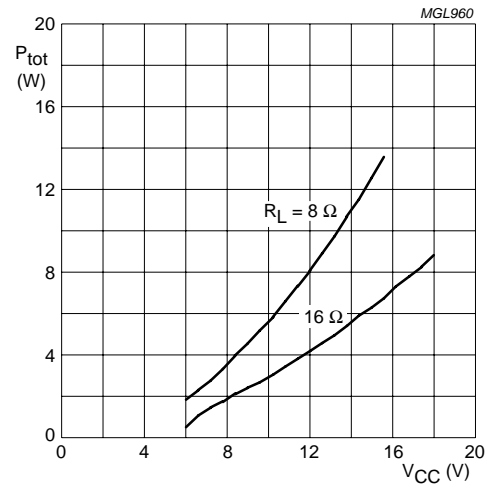
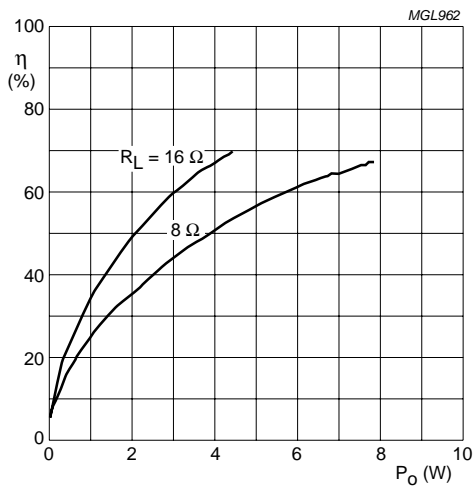

Fig 9. Total power dissipation as function of supply voltage.



$V_{CC} = 12\text{ V}$ .

Fig 10. Efficiency as function of output power.

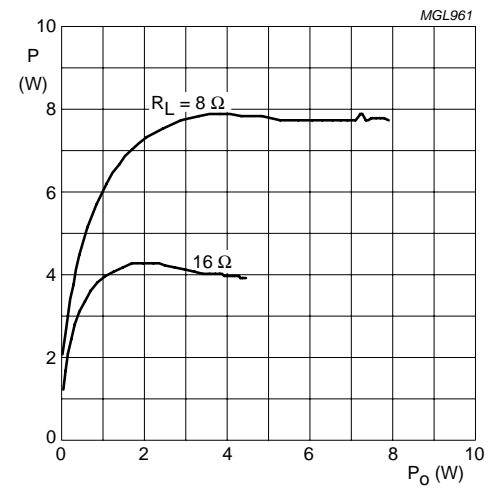
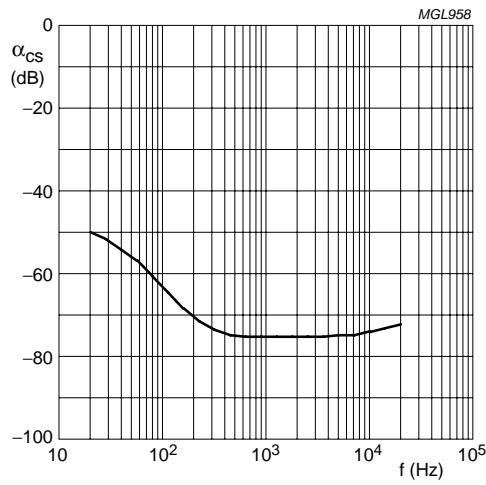
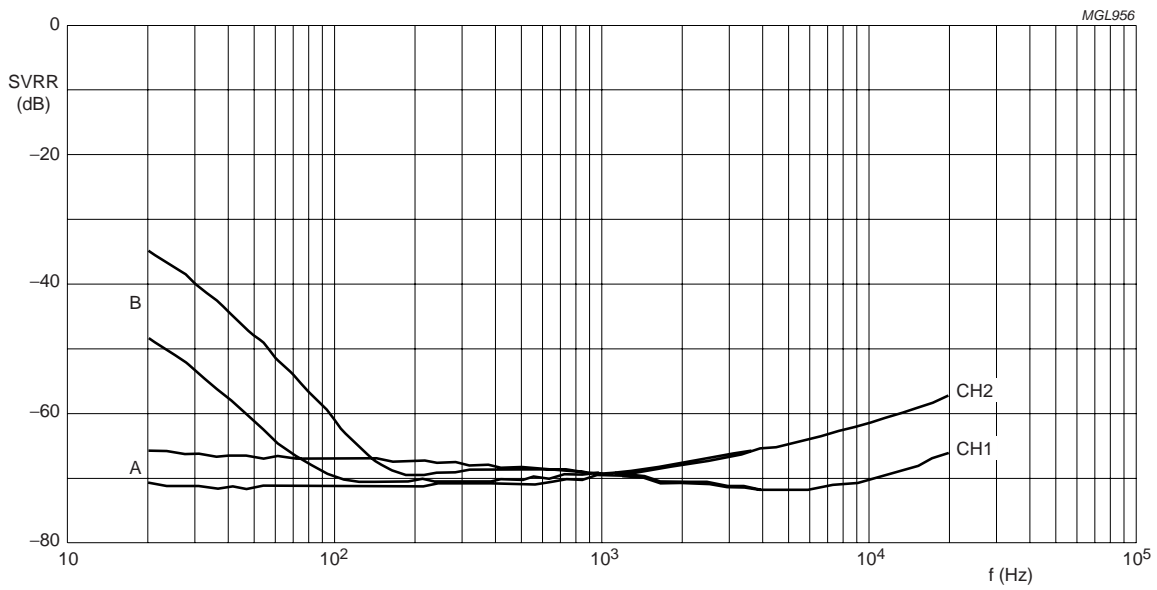

Fig 11. Power dissipation as function of output power.



No bandpass filter applied.

Fig 12. Channel separation as function of frequency.



$V_{CC} = 12\text{ V}$ ;  $R_s = 0\ \Omega$ ;  $V_{\text{ripple}} = 707\text{ mV}$  (peak-to-peak); no bandpass filter applied.

Curves A: inputs short-circuited

Curves B: inputs short-circuited and connected to ground (asymmetrical application)

Fig 13. Supply voltage ripple rejection as function of frequency.

13. Internal circuitry

Table 9: Internal circuitry

Pin	Symbol	Equivalent circuit
6 and 8	IN1+ and IN1-	
12 and 9	IN2+ and IN2-	
1 and 4	OUT1- and OUT1+	
14 and 17	OUT2- and OUT2+	
10	MODE	
11	SVR	

14. Application information

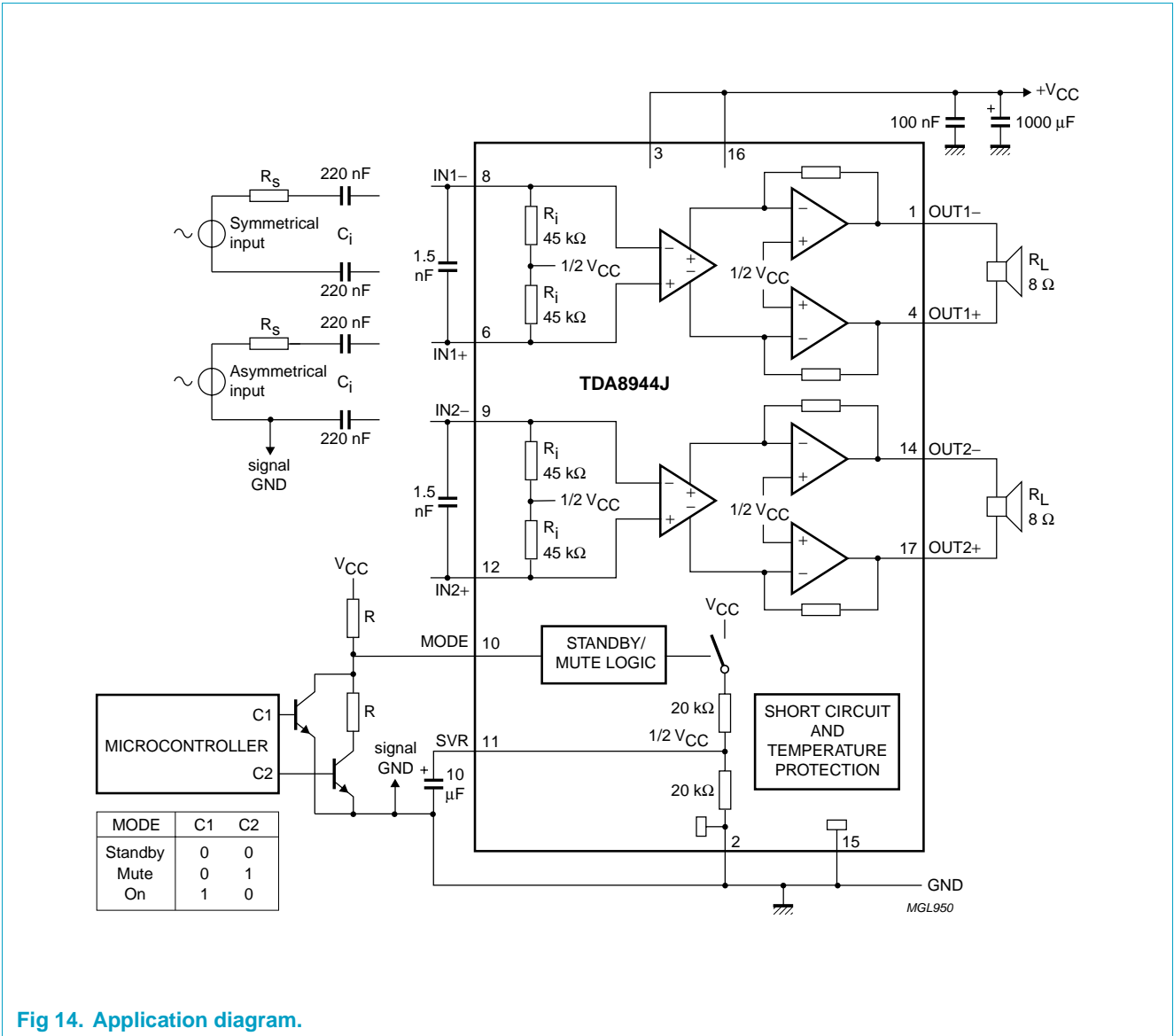

Fig 14. Application diagram.

14.1 Printed-circuit board (PCB)

14.1.1 Layout and grounding

For a high system performance level certain grounding techniques are essential. The input reference grounds have to be tied with their respective source grounds and must have separate tracks from the power ground tracks; this will prevent the large (output) signal currents from interfering with the small AC input signals. The small-signal ground tracks should be physically located as far as possible from the power ground tracks. Supply and output tracks should be as wide as possible for delivering maximum output power.

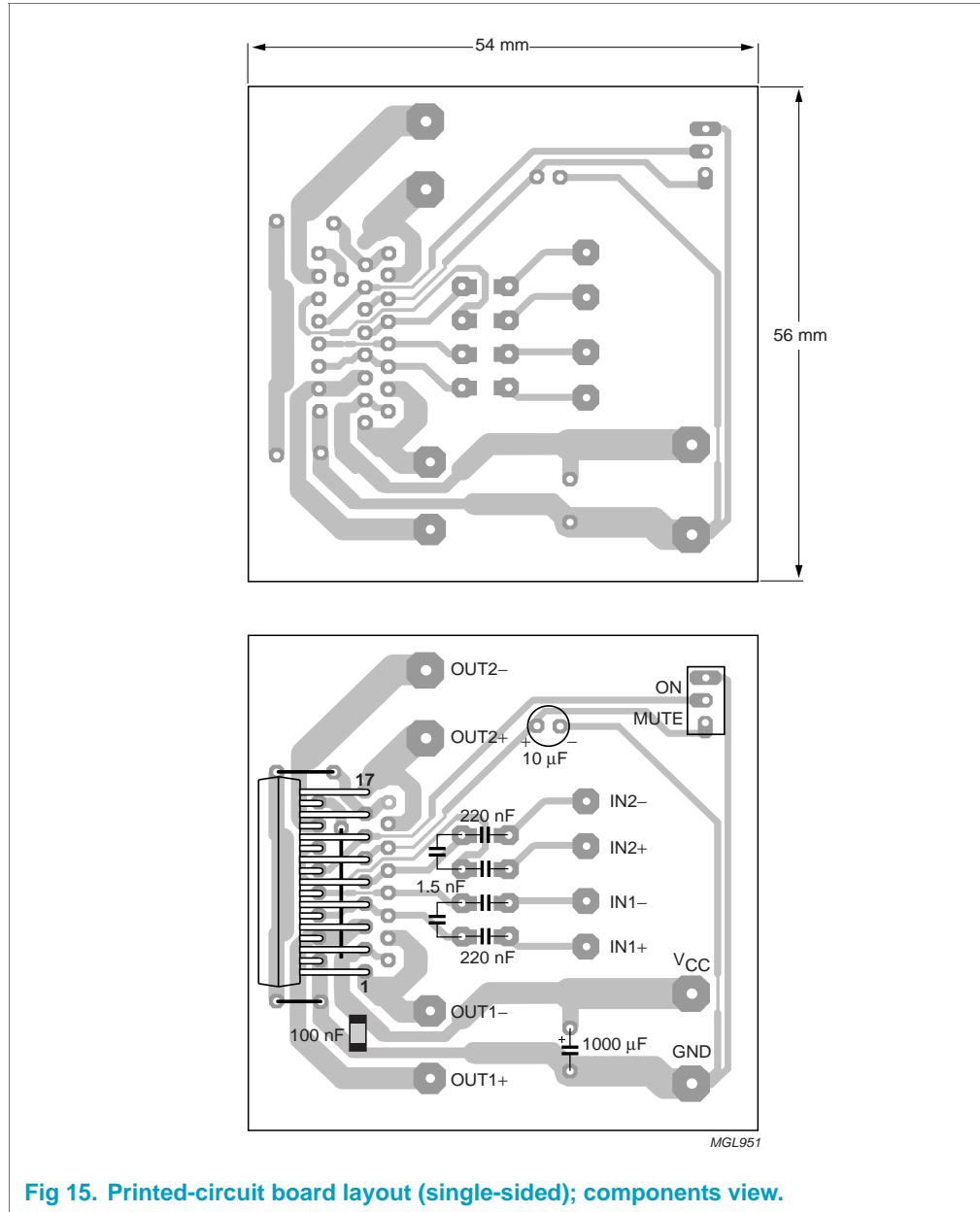

Fig 15. Printed-circuit board layout (single-sided); components view.

14.1.2 Power supply decoupling

Proper supply bypassing is critical for low-noise performance and high supply voltage ripple rejection. The respective capacitor locations should be as close as possible to the device and grounded to the power ground. Proper power supply decoupling also prevents oscillations.

For suppressing higher frequency transients (spikes) on the supply line a capacitor with low ESR – typical 100 nF – has to be placed as close as possible to the device. For suppressing lower frequency noise and ripple signals, a large electrolytic capacitor – e.g. 1000 μF or greater – must be placed close to the device.

The bypass capacitor on the SVR pin reduces the noise and ripple on the midrail voltage. For good THD and noise performance a low ESR capacitor is recommended.

## 14.2 Thermal behaviour and heatsink calculation

The measured maximum thermal resistance of the IC package,  $R_{th(j-mb)}$  is 6.9 K/W. A calculation for the heatsink can be made, with the following parameters:

$$T_{amb(max)} = 50 \text{ }^{\circ}\text{C}$$

$$V_{CC} = 12 \text{ V and } R_L = 8 \text{ } \Omega$$

$$T_{j(max)} = 150 \text{ }^{\circ}\text{C}.$$

$R_{th(tot)}$  is the total thermal resistance between the junction and the ambient including the heatsink. In the heatsink calculations the value of  $R_{th(mb-h)}$  is ignored.

At  $V_{CC} = 12 \text{ V}$  and  $R_L = 8 \text{ } \Omega$  the measured worstcase sine-wave dissipation is 8 W; see [Figure 11](#). For  $T_{j(max)} = 150 \text{ }^{\circ}\text{C}$  the temperature raise - caused by the power dissipation - is:  $150 - 50 = 100 \text{ }^{\circ}\text{C}$ .

$$P \times R_{th(tot)} = 100 \text{ }^{\circ}\text{C}$$

$$R_{th(tot)} = 100/8 = 12.5 \text{ K/W}$$

$$R_{th(h-a)} = R_{th(tot)} - R_{th(j-mb)} = 12.5 - 6.9 = 5.6 \text{ K/W}.$$

The calculation above is for an application at worstcase (stereo) sine-wave output signals. In practice music signals will be applied, which decreases the maximum power dissipation to approximately half of the sine-wave power dissipation (see [Section 8.2.2](#)). This allows for the use of a smaller heatsink:

$$P \times R_{th(tot)} = 100 \text{ }^{\circ}\text{C}$$

$$R_{th(tot)} = 100/4 = 25 \text{ K/W}$$

$$R_{th(h-a)} = R_{th(tot)} - R_{th(j-mb)} = 25 - 6.9 = 18.1 \text{ K/W}.$$

To increase the lifetime of the IC,  $T_{j(max)}$  should be reduced to 125  $^{\circ}\text{C}$ . This requires a heatsink of approximately 12 K/W for music signals.

## 15. Test information

### 15.1 Quality information

The *General Quality Specification for Integrated Circuits*, SNW-FQ-611 is applicable.

### 15.2 Test conditions

$T_{amb} = 25 \text{ }^{\circ}\text{C}$ ;  $V_{CC} = 12 \text{ V}$ ;  $f = 1 \text{ kHz}$ ;  $R_L = 8 \text{ } \Omega$ ; audio pass band 22 Hz to 22 kHz; unless otherwise specified.

**Remark:** In the graphs as function of frequency no bandpass filter was applied; see [Figure 7](#), [12](#) and [13](#).

16. Package outline

DBS17P: plastic DIL-bent-SIL power package; 17 leads (lead length 12 mm)

SOT243-1

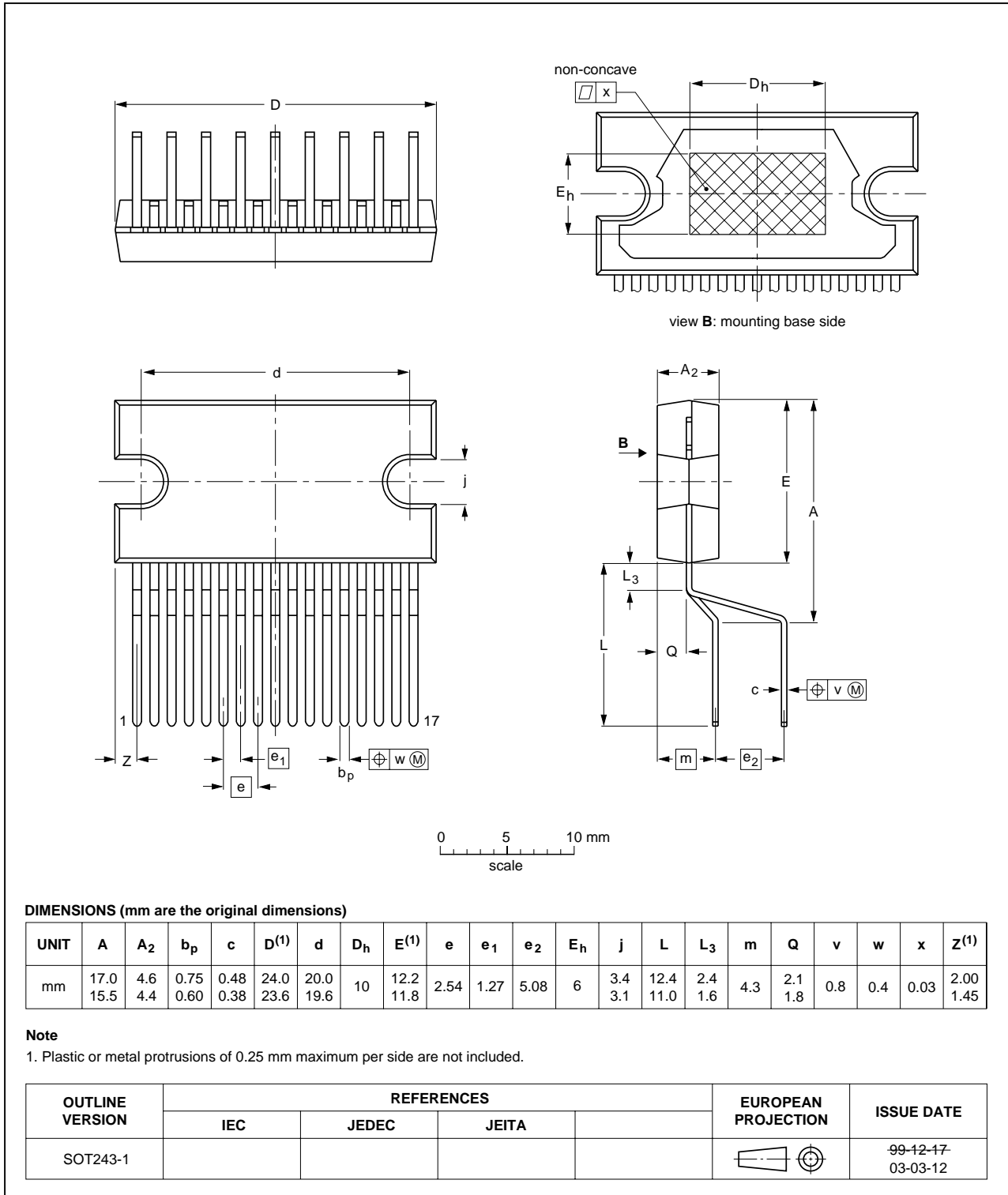

Fig 16. DBS17P package outline.



## 17. Soldering

### 17.1 Introduction to soldering through-hole mount packages

This text gives a brief insight to wave, dip and manual soldering. A more in-depth account of soldering ICs can be found in our *Data Handbook IC26; Integrated Circuit Packages* (document order number 9398 652 90011).

Wave soldering is the preferred method for mounting of through-hole mount IC packages on a printed-circuit board.

### 17.2 Soldering by dipping or by solder wave

Driven by legislation and environmental forces the worldwide use of lead-free solder pastes is increasing. Typical dwell time of the leads in the wave ranges from 3 to 4 seconds at 250 °C or 265 °C, depending on solder material applied, SnPb or Pb-free respectively.

The total contact time of successive solder waves must not exceed 5 seconds.

The device may be mounted up to the seating plane, but the temperature of the plastic body must not exceed the specified maximum storage temperature ( $T_{stg(max)}$ ). If the printed-circuit board has been pre-heated, forced cooling may be necessary immediately after soldering to keep the temperature within the permissible limit.

### 17.3 Manual soldering

Apply the soldering iron (24 V or less) to the lead(s) of the package, either below the seating plane or not more than 2 mm above it. If the temperature of the soldering iron bit is less than 300 °C it may remain in contact for up to 10 seconds. If the bit temperature is between 300 and 400 °C, contact may be up to 5 seconds.

### 17.4 Package related soldering information

**Table 10: Suitability of through-hole mount IC packages for dipping and wave soldering methods**

Package	Soldering method	
	Dipping	Wave
DBS, DIP, HDIP, RDBS, SDIP, SIL	suitable	suitable [1]
PMFP [2]	–	not suitable

[1] For SDIP packages, the longitudinal axis must be parallel to the transport direction of the printed-circuit board.

[2] For PMFP packages hot bar soldering or manual soldering is suitable.

## 18. Revision history

Table 11: Revision history

Rev	Date	CPCN	Description
02	000214	-	<p><b>Product specification; second version; supersedes initial version TDA8944J-01 of 14 April 1999 (9397 750 04881). Modifications:</b></p> <ul style="list-style-type: none"> <li>• <b>Table 1 on page 1:</b> SVRR; Typ value 65 dB → added</li> <li>• <b>Figure 1 on page 2:</b> Block diagram; pin numbers changed OUT2- → 14 and OUT2+ → 17</li> <li>• <b>Figure 2 on page 3:</b> Pin configuration; pin numbers changed OUT2- → 14 and OUT2+ → 17</li> <li>• <b>Section 8 “Functional description”:</b> <ul style="list-style-type: none"> <li>– <b>Section 8.1 “Input configuration” on page 4</b> → added.</li> <li>– <b>Section 8.2 “Power amplifier” on page 5:</b> ....., capable of delivering a peak output current of 1.5 A → changed to 2 A.</li> <li>– <b>Section 8.2.1 “Output power measurement” on page 5</b> → added</li> <li>– <b>Section 8.2.2 “Headroom” on page 5</b> → added</li> </ul> </li> <li>• <b>Section 8.3 “Mode selection”:</b> <ul style="list-style-type: none"> <li>– Standby mode: <math>V_{\text{MODE}} &gt; (V_{\text{CC}} - 0.5 \text{ V})</math> → changed to <math>(V_{\text{CC}} - 0.5 \text{ V}) &lt; V_{\text{MODE}} &lt; V_{\text{CC}}</math>; The power consumption of the TDA8944J will be reduced to <math>&lt; 0.18 \text{ mW}</math> → added.</li> <li>– Mute mode: the DC level of the input and output pins remain on half the supply voltage → added;</li> <li>– <math>2.5 \text{ V} &lt; V_{\text{MODE}} &lt; (V_{\text{CC}} - 1.5 \text{ V})</math> → changed to <math>3 \text{ V} &lt; V_{\text{MODE}} &lt; (V_{\text{CC}} - 1.5 \text{ V})</math></li> <li>– <b>Section 8.3.1 “Switch-on and switch-off” on page 6</b></li> </ul> </li> <li>• <b>Section 8.4 “Supply Voltage Ripple Rejection (SVRR)” on page 6</b> → added</li> <li>• <b>Section 8.5 “Built-in protection circuits” on page 6</b> → added</li> <li>• <b>Table 5 on page 7:</b> <ul style="list-style-type: none"> <li>– <math>P_{\text{tot}}</math> value added 18 W</li> <li>– <math>V_{\text{CC(sc)}}</math> value added 15 V</li> </ul> </li> <li>• <b>Table 6 on page 7:</b> <ul style="list-style-type: none"> <li>– <math>R_{\text{th(j-a)}}</math> value added 40 K/W</li> <li>– <math>R_{\text{th(j-c)}}</math> value 10 → changed to 6.9 K/W; condition ‘in free air’ → changed to ‘both channels driven’</li> </ul> </li> <li>• <b>Table 7 on page 7:</b> <math>V_{\text{MODE}}</math> - mute mode - value Min 2.5 → changed to 3 V</li> <li>• <b>Table 8 on page 8:</b> <ul style="list-style-type: none"> <li>– SVRR; Typ values 65 and 60 dB → added</li> <li>– <math>\alpha_{\text{CS}}</math>; Typ value 75 dB → added</li> </ul> </li> <li>• <b>Figure 3 to 13:</b> figures added</li> <li>• <b>Section 13 “Internal circuitry” on page 12:</b> → added</li> <li>• <b>Figure 14:</b> figure adjusted</li> <li>• <b>Section 14.1 “Printed-circuit board (PCB)” on page 13:</b> → added</li> <li>• <b>Figure 15:</b> figure added</li> <li>• <b>Section 14.2 “Thermal behaviour and heatsink calculation” on page 15:</b> → added</li> <li>• <b>Section 15.2 “Test conditions” on page 15:</b> → added</li> </ul>
01	990414	-	<b>Preliminary specification; initial version.</b>

## 19. Data sheet status

Document status <sup>[1][2]</sup>	Product status <sup>[3]</sup>	Definition
Objective [short] data sheet	Development	This document contains data from the objective specification for product development.
Preliminary [short] data sheet	Qualification	This document contains data from the preliminary specification.
Product [short] data sheet	Production	This document contains the product specification.

[1] Please consult the most recently issued document before initiating or completing a design.

[2] The term 'short data sheet' is explained in section "Definitions".

[3] The product status of device(s) described in this document may have changed since this document was published and may differ in case of multiple devices. The latest product status information is available on the Internet at URL <http://www.nxp.com>.

## 20. Definitions

**Draft** — The document is a draft version only. The content is still under internal review and subject to formal approval, which may result in modifications or additions. NXP Semiconductors does not give any representations or warranties as to the accuracy or completeness of information included herein and shall have no liability for the consequences of use of such information.

**Short data sheet** — A short data sheet is an extract from a full data sheet with the same product type number(s) and title. A short data sheet is intended for quick reference only and should not be relied upon to contain detailed and full information. For detailed and full information see the relevant full data sheet, which is available on request via the local NXP Semiconductors sales office. In case of any inconsistency or conflict with the short data sheet, the full data sheet shall prevail.

**Product specification** — The information and data provided in a Product data sheet shall define the specification of the product as agreed between NXP Semiconductors and its customer, unless NXP Semiconductors and customer have explicitly agreed otherwise in writing. In no event however, shall an agreement be valid in which the NXP Semiconductors product is deemed to offer functions and qualities beyond those described in the Product data sheet.

## 21. Disclaimers

**Limited warranty and liability** — Information in this document is believed to be accurate and reliable. However, NXP Semiconductors does not give any representations or warranties, expressed or implied, as to the accuracy or completeness of such information and shall have no liability for the consequences of use of such information.

In no event shall NXP Semiconductors be liable for any indirect, incidental, punitive, special or consequential damages (including - without limitation - lost profits, lost savings, business interruption, costs related to the removal or replacement of any products or rework charges) whether or not such damages are based on tort (including negligence), warranty, breach of contract or any other legal theory.

Notwithstanding any damages that customer might incur for any reason whatsoever, NXP Semiconductors' aggregate and cumulative liability towards customer for the products described herein shall be limited in accordance with the *Terms and conditions of commercial sale* of NXP Semiconductors.

**Right to make changes** — NXP Semiconductors reserves the right to make changes to information published in this document, including without limitation specifications and product descriptions, at any time and without notice. This document supersedes and replaces all information supplied prior to the publication hereof.

**Suitability for use** — NXP Semiconductors products are not designed, authorized or warranted to be suitable for use in life support, life-critical or safety-critical systems or equipment, nor in applications where failure or malfunction of an NXP Semiconductors product can reasonably be expected

to result in personal injury, death or severe property or environmental damage. NXP Semiconductors accepts no liability for inclusion and/or use of NXP Semiconductors products in such equipment or applications and therefore such inclusion and/or use is at the customer's own risk.

**Applications** — Applications that are described herein for any of these products are for illustrative purposes only. NXP Semiconductors makes no representation or warranty that such applications will be suitable for the specified use without further testing or modification.

Customers are responsible for the design and operation of their applications and products using NXP Semiconductors products, and NXP Semiconductors accepts no liability for any assistance with applications or customer product design. It is customer's sole responsibility to determine whether the NXP Semiconductors product is suitable and fit for the customer's applications and products planned, as well as for the planned application and use of customer's third party customer(s). Customers should provide appropriate design and operating safeguards to minimize the risks associated with their applications and products.

NXP Semiconductors does not accept any liability related to any default, damage, costs or problem which is based on any weakness or default in the customer's applications or products, or the application or use by customer's third party customer(s). Customer is responsible for doing all necessary testing for the customer's applications and products using NXP Semiconductors products in order to avoid a default of the applications and the products or of the application or use by customer's third party customer(s). NXP does not accept any liability in this respect.

**Limiting values** — Stress above one or more limiting values (as defined in the Absolute Maximum Ratings System of IEC 60134) will cause permanent damage to the device. Limiting values are stress ratings only and (proper) operation of the device at these or any other conditions above those given in the Recommended operating conditions section (if present) or the Characteristics sections of this document is not warranted. Constant or repeated exposure to limiting values will permanently and irreversibly affect the quality and reliability of the device.

**Terms and conditions of commercial sale** — NXP Semiconductors products are sold subject to the general terms and conditions of commercial sale, as published at <http://www.nxp.com/profile/terms>, unless otherwise agreed in a valid written individual agreement. In case an individual agreement is concluded only the terms and conditions of the respective agreement shall apply. NXP Semiconductors hereby expressly objects to applying the customer's general terms and conditions with regard to the purchase of NXP Semiconductors products by customer.

**No offer to sell or license** — Nothing in this document may be interpreted or construed as an offer to sell products that is open for acceptance or the grant, conveyance or implication of any license under any copyrights, patents or other industrial or intellectual property rights.

**Export control** — This document as well as the item(s) described herein may be subject to export control regulations. Export might require a prior authorization from national authorities.

**Quick reference data** — The Quick reference data is an extract of the product data given in the Limiting values and Characteristics sections of this document, and as such is not complete, exhaustive or legally binding.

**Non-automotive qualified products** — Unless this data sheet expressly states that this specific NXP Semiconductors product is automotive qualified, the product is not suitable for automotive use. It is neither qualified nor tested in accordance with automotive testing or application requirements. NXP Semiconductors accepts no liability for inclusion and/or use of non-automotive qualified products in automotive equipment or applications.

In the event that customer uses the product for design-in and use in automotive applications to automotive specifications and standards, customer (a) shall use the product without NXP Semiconductors' warranty of

the product for such automotive applications, use and specifications, and (b) whenever customer uses the product for automotive applications beyond NXP Semiconductors' specifications such use shall be solely at customer's own risk, and (c) customer fully indemnifies NXP Semiconductors for any liability, damages or failed product claims resulting from customer design and use of the product for automotive applications beyond NXP Semiconductors' standard warranty and NXP Semiconductors' product specifications.

## NXP Semiconductors

*provides High Performance Mixed Signal and Standard Product solutions that leverage its leading RF, Analog, Power Management, Interface, Security and Digital Processing expertise*

### Customer notification

This data sheet was changed to reflect the new company name NXP Semiconductors, including new legal definitions and disclaimers. No changes were made to the technical content, except for package outline drawings which were updated to the latest version.

### Contact information

For more information, please visit: <http://www.nxp.com>

For sales office addresses, please send an email to: [salesaddresses@nxp.com](mailto:salesaddresses@nxp.com)

## Contents

<b>1</b>	<b>General description</b> . . . . .	<b>1</b>
<b>2</b>	<b>Features</b> . . . . .	<b>1</b>
<b>3</b>	<b>Applications</b> . . . . .	<b>1</b>
<b>4</b>	<b>Quick reference data</b> . . . . .	<b>1</b>
<b>5</b>	<b>Ordering information</b> . . . . .	<b>2</b>
<b>6</b>	<b>Block diagram</b> . . . . .	<b>2</b>
<b>7</b>	<b>Pinning information</b> . . . . .	<b>3</b>
7.1	Pinning . . . . .	3
7.2	Pin description . . . . .	3
<b>8</b>	<b>Functional description</b> . . . . .	<b>4</b>
8.1	Input configuration . . . . .	4
8.2	Power amplifier . . . . .	5
8.2.1	Output power measurement . . . . .	5
8.2.2	Headroom . . . . .	5
8.3	Mode selection . . . . .	5
8.3.1	Switch-on and switch-off . . . . .	6
8.4	Supply Voltage Ripple Rejection (SVRR) . . . . .	6
8.5	Built-in protection circuits . . . . .	6
8.5.1	Short-circuit protection . . . . .	6
8.5.2	Thermal shutdown protection . . . . .	6
<b>9</b>	<b>Limiting values</b> . . . . .	<b>7</b>
<b>10</b>	<b>Thermal characteristics</b> . . . . .	<b>7</b>
<b>11</b>	<b>Static characteristics</b> . . . . .	<b>7</b>
<b>12</b>	<b>Dynamic characteristics</b> . . . . .	<b>8</b>
<b>13</b>	<b>Internal circuitry</b> . . . . .	<b>12</b>
<b>14</b>	<b>Application information</b> . . . . .	<b>13</b>
14.1	Printed-circuit board (PCB) . . . . .	13
14.1.1	Layout and grounding . . . . .	13
14.1.2	Power supply decoupling . . . . .	14
14.2	Thermal behaviour and heatsink calculation . . . . .	15
<b>15</b>	<b>Test information</b> . . . . .	<b>15</b>
15.1	Quality information . . . . .	15
15.2	Test conditions . . . . .	15
<b>16</b>	<b>Package outline</b> . . . . .	<b>16</b>
<b>17</b>	<b>Soldering</b> . . . . .	<b>17</b>
17.1	Introduction to soldering through-hole mount packages . . . . .	17
17.2	Soldering by dipping or by solder wave . . . . .	17
17.3	Manual soldering . . . . .	17
17.4	Package related soldering information . . . . .	17
<b>18</b>	<b>Revision history</b> . . . . .	<b>18</b>
<b>19</b>	<b>Data sheet status</b> . . . . .	<b>19</b>
<b>20</b>	<b>Definitions</b> . . . . .	<b>19</b>
<b>21</b>	<b>Disclaimers</b> . . . . .	<b>19</b>