

# DATA SHEET

**TDA9151B**

**Programmable deflection controller**

Preliminary specification  
Supersedes data of June 1993  
File under Integrated Circuits, IC02

July 1994

**Philips Semiconductors**



**PHILIPS**

# Programmable deflection controller

# TDA9151B

## FEATURES

### General

- 6.75, 13.5 and 27 MHz clock frequency
- Few external components
- Synchronous logic
- I<sup>2</sup>C-bus controlled
- Easy interfacing
- Low power
- ESD protection
- Flash detection with restart
- Two-level sandcastle pulse.

### Vertical deflection

- 16-bit precision vertical scan
- Self adaptive or programmable fixed slope mode
- DC coupled deflection to prevent picture bounce
- Programmable fixed compression to 75%
- Programmable vertical expansion in the fixed slope mode
- S-correction can be preset
- S-correction setting independent of the field frequency
- Differential output for high DC stability
- Current source outputs for high EMC immunity
- Programmable de-interlace phase.

### East-West correction

- DC coupled EW correction to prevent picture bounce
- 2nd and 4th order geometry correction can be preset
- Trapezium correction
- Geometry correction settings are independent of field frequency
- Self adaptive Bult generator prevents ringing of the horizontal deflection
- Current source output for high EMC immunity.



### Horizontal deflection

- Phase 2 loop with low jitter
- Internal loop filter
- Dual slicer horizontal flyback input
- Soft start by I<sup>2</sup>C-bus
- Over voltage protection/detection with selection and status bit.

### EHT correction

- Input selection between aquadag or EHT bleeder
- Internal filter.

## GENERAL DESCRIPTION

The TDA9151B is a programmable deflection controller contained in a 20-pin DIP package and constructed using BIMOS technology. This high performance synchronization and DC deflection processor has been especially designed for use in both digital and analog based TV receivers and monitors, and serves horizontal and vertical deflection functions for all TV standards. The TDA9151B uses a line-locked clock at 6.75, 13.5 or 27 MHz, depending on the line frequency and application, and requires only a few external components. The device can be programmed in a self-adaptive mode or in a programmable fixed slope mode. Selection of these modes and a large number of other functions is fully programmable via the I<sup>2</sup>C-bus.

## ORDERING INFORMATION

TYPE NUMBER	PACKAGE			
	PINS	PIN POSITION	MATERIAL	CODE
TDA9151B	20	DIP	plastic	SOT146-1

## Programmable deflection controller

TDA9151B

## QUICK REFERENCE DATA

SYMBOL	PARAMETER	CONDITIONS	MIN.	TYP.	MAX.	UNIT
$V_{CC}$	supply voltage		7.2	8.0	8.8	V
$I_{CC}$	supply current	$f_{clk} = 6.75$ MHz	–	27	–	mA
$P_{tot}$	total power dissipation		–	220	–	mW
$T_{amb}$	operating ambient temperature		–25	–	+70	°C
<b>Inputs</b>						
$V_{14}$	line-locked clock (LLC) logic level		–	TTL	–	
$V_{13}$	horizontal sync ( $H_A$ ) logic level		–	TTL	–	
$V_{12}$	vertical sync ( $V_A$ ) logic level		–	TTL	–	
$V_5$	line-locked clock select (LLCS) logic level	note 1	–	CMOS 5 V	–	
$V_{18}$	serial clock (SCL) logic level		–	CMOS 5 V	–	
$V_{17}$	serial data input (SDA) logic level		–	CMOS 5 V	–	
$V_1$	horizontal flyback (HFB) phase slicing level	FBL = logic 0	–	3.9	–	V
		FBL = logic 1	–	1.3	–	V
$V_1$	horizontal flyback (HFB) blanking slicing level		–	100	–	mV
$V_3$	over voltage protection (PROT) level		–	3.9	–	V
$V_9$	EHT flash detection level		–	1.5	–	V
<b>Outputs</b>						
$V_{20}$	horizontal output (HOUT) voltage (open drain)	$I_{20} = 10$ mA	–	–	0.5	V
$I_{11}-I_{10(M)}$	vertical differential ( $VOUT_{A, B}$ ) output current (peak value)	vertical amplitude = 100%; $I_8 = -120$ $\mu$ A; note 2	440	475	510	$\mu$ A
$V_{10,11}$	vertical output voltage		0	–	3.9	V
$I_{6(M)}$	EW (EWOUT) total output current (peak value)	$I_8 = -120$ $\mu$ A	–	–	930	$\mu$ A
$V_6$	EW (EWOUT) output voltage		1.0	–	5.5	V
SANDCASTLE OUTPUT LEVELS (DSC)						
$V_2$	base voltage level		–	0.5	–	V
$V_2$	horizontal and vertical blanking voltage level		–	2.5	–	V
$V_2$	video clamping voltage level		–	4.5	–	V
HORIZONTAL OFF-CENTRE SHIFT (OFCS)						
$V_{19}$	output voltage	$I_{19} = 2$ mA	0	–	$V_{CC}$	V

## Notes

1. Hard wired to ground or  $V_{CC}$  is highly recommended.
2. DAC values: vertical amplitude = 31; EHT = 0; SHIFT = 3; SCOR = 0.

Programmable deflection controller

TDA9151B

BLOCK DIAGRAM

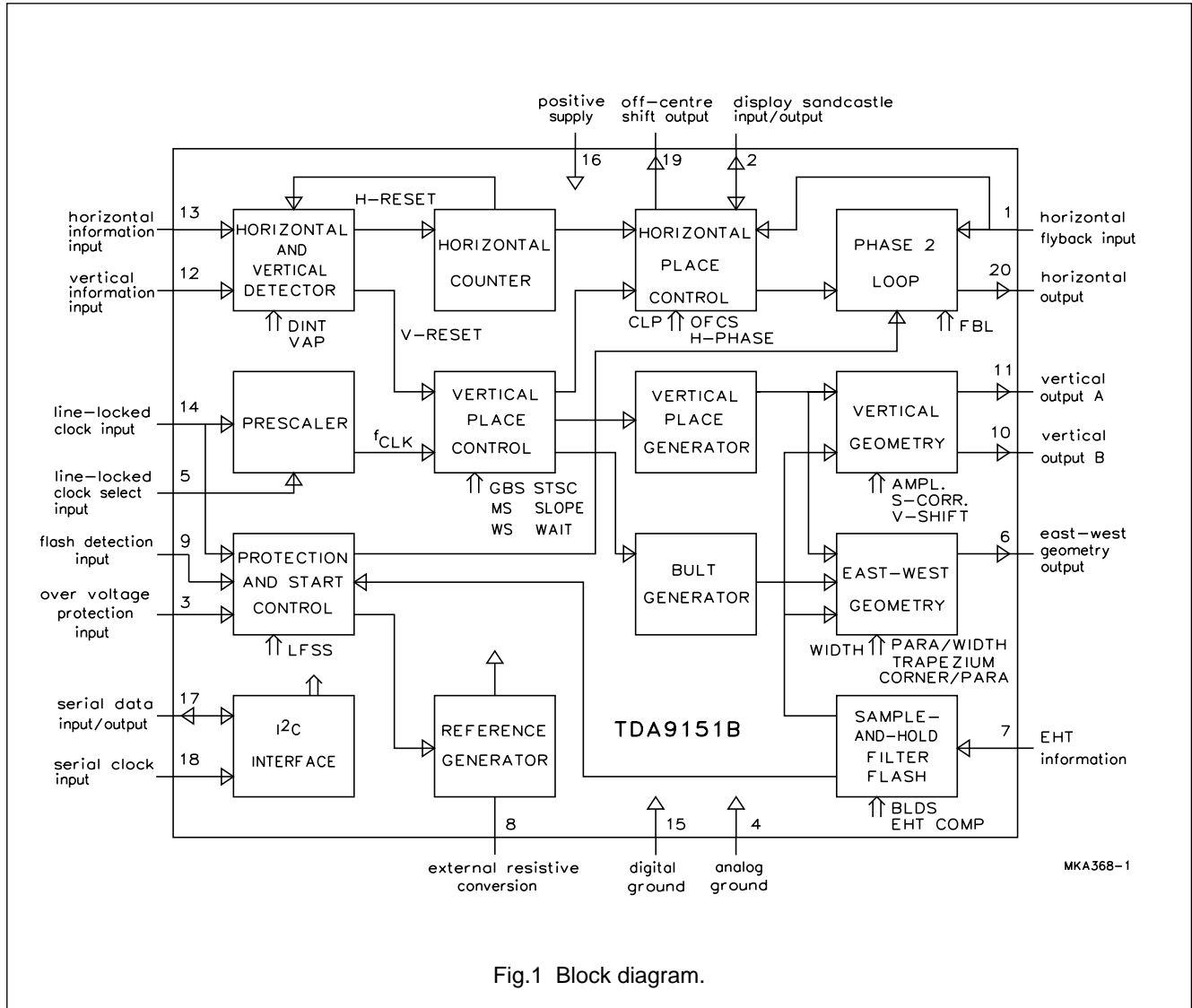

Fig.1 Block diagram.

MKA368-1

## Programmable deflection controller

## TDA9151B

## PINNING

SYMBOL	PIN	DESCRIPTION
HFB	1	horizontal flyback input
DSC	2	display sandcastle input/output
PROT	3	over voltage protection input
AGND	4	analog ground
LLCS	5	line-locked clock selection input
EWOUT	6	east-west geometry output
EHT	7	EHT compensation
R <sub>CONV</sub>	8	external resistive conversion
FLASH	9	flash detection input
VOU <sub>TB</sub>	10	vertical output B
VOU <sub>TA</sub>	11	vertical output A
V <sub>A</sub>	12	vertical information input
H <sub>A</sub>	13	horizontal information input
LLC	14	line-locked clock input
DGND	15	digital ground
V <sub>CC</sub>	16	supply input (+8 V)
SDA	17	serial data input/output
SCL	18	serial clock input
OFCS	19	off-centre shift output
HOUT	20	horizontal output

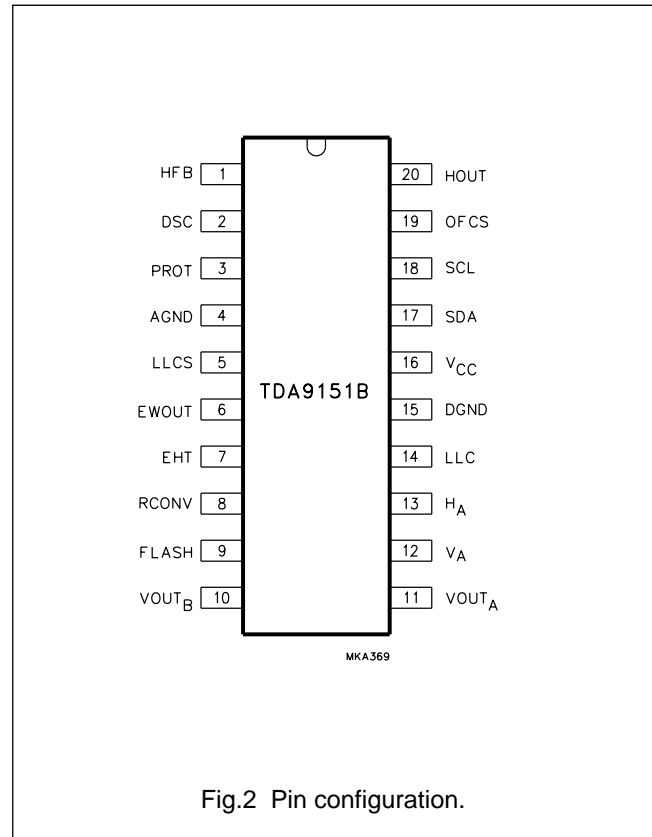

Fig.2 Pin configuration.

## FUNCTIONAL DESCRIPTION

## Input signals (pins 12, 13, 14, 17 and 18)

The TDA9151B requires three signals for minimum operation (apart from the supply). These signals are the line-locked clock (LLC) and the two I<sup>2</sup>C-bus signals (SDA and SCL). Without the LLC the device will not operate because the internal synchronous logic uses the LLC as the system clock.

I<sup>2</sup>C-bus transmissions are required to enable the device to perform its required tasks. Once started the IC will use the H<sub>A</sub> and/or V<sub>A</sub> inputs for synchronization. If the LLC is not

present the outputs will be switched off and all operations discarded (if the LLC is not present the line drive will be inhibited within 2 μs, the EW output current will drop to zero and the vertical output current will drop to 20% of the adjusted value within 100 μs). The SDA and SCL inputs meet the I<sup>2</sup>C-bus specification, the other three inputs are TTL compatible.

The LLC frequency can be divided-by-two internally by connecting LLCS (pin 5) to ground thereby enabling the prescaler.

The LLC timing is given in the Chapter "Characteristics".

## Programmable deflection controller

## TDA9151B

**I<sup>2</sup>C-bus commands**Slave address: **8C HEX = 1000110X BIN**

## READ MODE

The format of the status byte is: PON PROT 0 0 0 0 0 0

Where:

PON is the status bit for power-on reset (POR) and after power failure:

- Logic 1:
  - after the first POR and after power failure; also set to 1 after a severe voltage dip that may have disturbed the various settings
  - POR 1 to 0 transition,  $V_{CC} = 6.25\text{ V}$  (typ.)
  - POR 0 to 1 transition,  $V_{CC} = 5.75\text{ V}$  (typ.)

- Logic 0:
  - after a successful read of the status byte.

PROT is the over voltage detection for the scaled EHT input:

- Logic 1:
  - if the scaled EHT rises above the reference value of 3.9 V
- Logic 0:
  - after a successful read of the status byte and EHT < 3.9 V.

**Remark:** a read action is considered successful when an End Of Data signal has been detected (i.e. no master acknowledge).

**Table 1** Write mode with auto increment; subaddress and data byte format.

FUNCTION	SUBADDRESS	DATA BYTE							
		D7	D6	D5	D4	D3	D2	D1	D0
Vertical amplitude	00	X <sup>(1)</sup>	X	A5	A4	A3	A2	A1	A0
Vertical S-correction	01	X	X	A5	A4	A3	A2	A1	A0
Vertical start scan	02	X	X	A5	A4	A3	A2	A1	A0
Vertical off-centre shift	03	X	note 2	note 2	note 2	X	A2	A1	A0
EW trapezium correction	03	X	A6	A5	A4	X	note 2	note 2	note 2
EW width/width ratio	04	X	X	A5	A4	A3	A2	A1	A0
EW parabola/width ratio	05	X	X	A5	A4	A3	A2	A1	A0
EW corner/parabola ratio	06	X	X	A5	A4	A3	A2	A1	A0
EHT compensation	07	X	X	A5	A4	A3	A2	A1	A0
Horizontal phase	08	X	X	A5	A4	A3	A2	A1	A0
Horizontal off-centre shift	09	X	X	A5	A4	A3	A2	A1	A0
Clamp shift	0A	X	X	X	X	X	A2	A1	A0
Control 1	0B	MS	WS	FBL	VAP	BLDS	LFSS	DINT	GBS
Vertical slope MSB	0C	A7	A6	A5	A4	A3	A2	A1	A0
Vertical slope LSB	0D	A7	A6	A5	A4	A3	A2	A1	A0
Vertical wait	0E	A7	A6	A5	A4	A3	A2	A1	A0
Control 2	0F	X	X	X	VPR	CPR	DIP	PRD	CSU

**Notes**

1. X = don't care.
2. Data bit used in another function.

## Programmable deflection controller

TDA9151B

Table 2 Control bits.

CONTROL BIT	LOGIC	FUNCTION
LFSS	0	Line stop: EW output current becomes zero and the vertical output current is reduced to 20% of the adjusted value. LFSS becomes logic 0 after a HIGH on PON.
	1	Line start enabled: the soft start mechanism is now activated.
DINT	0	De-interlace on: the $V_A$ pulse is sampled at a position selected with control bit DIP.
	1	De-interlace off: the $V_A$ pulse is sampled with the system clock and the detected rising edge is used as vertical reset.
BLDS	0	Aquadag selected.
	1	Bleeder selected.
GBS	0	Becomes logic 0 after power-on.
	1	Guard band 48/12 lines.
VAP	0	Positive $V_A$ edge detection.
	1	Negative $V_A$ edge detection.
FBL	0	Horizontal flyback slicing level = 3.9 V.
	1	Horizontal flyback slicing level = 1.3 V.
WS	0	No wait state.
	1	Programmable wait state (only in constant slope mode; MS = logic 1).
MS	0	Adaptive mode with guardband amplitude control.
	1	Constant slope mode (programmable).
CSU	0	No clamping suppression, standard mode of operation.
	1	Clamping suppression in wait, stop and protection modes (used in systems with e.g. TDA4680/81).
PRD	0	No defeat of HOUT, the over voltage information is only written in the PROT status bit.
	1	HOUT is defeated and status bit PROT is set when over voltage is detected.
DIP	0	$V_A$ is sampled 42 clock pulses after the leading edge of $H_A$ .
	1	$V_A$ is sampled 258 clock pulses after the leading edge of $H_A$ .
CPR	0	Nominal amplitude.
	1	Compression to 75% of adjusted amplitude, used for display of 16 : 9 standard pictures on 4 : 3 displays.
VPR	0	Nominal amplitude (100%) during wait, stop and clipping.
	1	Amplitude reduced to 20% during wait, stop and clipping.

## Programmable deflection controller

## TDA9151B

**Table 3** Explanation of control bits shown in Table 2.

CONTROL BITS	DESCRIPTION
LFSS	line frame start/stop
DINT	de-interlace
BLDS	bleeder mode selection
GBS	guard band selection
VAP	polarity of $V_A$ edge detection
FBL	flyback slicing level
WS	wait state on/off
MS	mode select
CSU	clamping suppression mode
PRD	protection/detection mode
DIP	de-interlace phase
CPR	compression on/off
VPR	vertical power reduction mode

**Table 4** Clock frequency control bit (pin 5; note 1).

CONTROL BIT	LOGIC	FUNCTION
LLCS	0	prescaler on: the internal clock frequency $f_{clk} = \frac{1}{2}f_{LLC}$
	1	prescaler off (default by internal pull-up resistor): the internal clock frequency $f_{clk} = f_{LLC}$

**Note**

- Switching of the prescaler is only allowed when LFSS is LOW. It is highly recommended to hard wire LLCS to ground or  $V_{CC}$ . Active switching may damage the output power transistor due to the changing HOUT pulse. This may cause very high currents and large flyback pulses. The permitted combinations of LLC and the prescaler are shown in Table 5.

**Table 5** Line duration with prescaler.

LLC (MHz)	ON ( $\mu$ s)	OFF ( $\mu$ s)
6.75	note 1	64
13.5	64	32
27	32	note 1

**Note**

- Combination not allowed.



Programmable deflection controller

TDA9151B

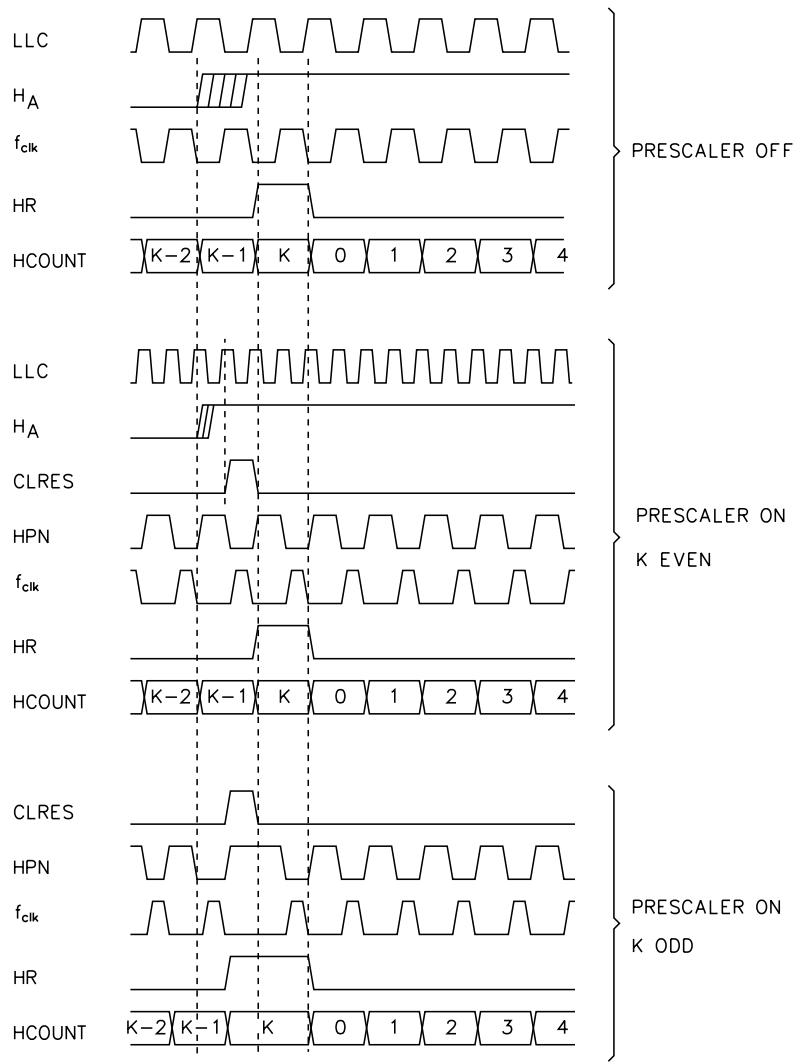

RESET INTERNAL LINE COUNTER WITH  $H_A$

MKA715

Fig.3 Timing relations between LLC,  $H_A$  and line counter.

## Programmable deflection controller

## TDA9151B

### Horizontal part (pins 1, 2, 13, 19 and 20)

#### SYNCHRONIZATION PULSE

The  $H_A$  input (pin 13) is a TTL-compatible CMOS input. Pulses on this input have to fulfil the timing requirements as illustrated in Fig.6. For correct detection the minimum pulse width for both the HIGH and LOW periods is 2 internal clock periods.

#### FLYBACK INPUT PULSE

The HFB input (pin 1) is a CMOS input. The delay of the centre of the flyback pulse to the leading edge of the  $H_A$  pulse can be set via the I<sup>2</sup>C-bus with the horizontal phase byte (subaddress 08), as illustrated in Fig.7. The resolution is 6-bit.

#### OUTPUT PULSE

The HOUT pulse (pin 20) is an open-drain NMOS output. The duty factor for this output is typically  $52/48$  (conducting/non-conducting) during normal operation. A soft start causes the duty factor to increase linearly from 5 to 52% over a minimum period of 2000 lines in 2000 steps.

#### OFF-CENTRE SHIFT

The OFCS output (pin 19) is a push-pull CMOS output which is driven by a pulse-width modulated DAC.

By using a suitable interface, the output signal can be used for off-centre shift correction in the horizontal output stage. This correction is required for HDTV tubes with a  $16 \times 9$  aspect ratio and is useful for high performance flat square tubes to obtain the required horizontal linearity. For applications where off-centre correction is not required, the output can be used as an auxiliary DAC. The OFCS signal is phase-locked with the line frequency. The off-centre shift can be set via the I<sup>2</sup>C-bus, subaddress 09, with a 6-bit resolution as illustrated in Fig.8.

#### SANDCASTLE

The DSC input/output (pin 2) acts as a sandcastle generating output and a guard sensing input. As an output it provides 2 levels (apart from the base level), one for the horizontal and vertical blanking and the other for the video clamping. As an input it acts as a current sensor during the vertical blanking interval for guard detection.

#### CLAMPING PULSE

The clamping pulse width is 21 internal clock periods. The shift, with respect to  $H_A$  can be varied from 35 to 49 clock periods in 7 steps via the I<sup>2</sup>C-bus, clamp shift byte subaddress 0A, as illustrated in Fig.9. It is possible to suppress the clamping pulse during wait, stop and protection modes with control bit CSU. This will avoid unwanted reset of the TDA4680/81 (only used in those circuits).

#### HORIZONTAL BLANKING

The start of the horizontal blanking pulse is minimum 38 and maximum 41 clock periods before the centre of the flyback pulse, depending on the  $f_{\text{clk}}/f_{\text{H}}$  ratio K in accordance with  $41 - (432 - K)$ .

Stop of the horizontal blanking pulse is determined by the trailing edge of the HFB pulse at the horizontal blanking slicing level crossing as illustrated in Fig.10.

#### VERTICAL BLANKING

The vertical blanking pulse starts two internal clock pulses after the rising edge of the  $V_A$  pulse. During this interval a small guard pulse, generated during flyback by the vertical power output stage, must be inserted. Stop vertical blanking is effected at the end of the blanking interval only when the guard pulse is present (see Section "Vertical guard").

The start scan setting determines the end of vertical blanking with a 6-bit resolution in steps of one line via the I<sup>2</sup>C-bus subaddress 02 (see Figs 11, 12 and 13).

#### VERTICAL GUARD

In the vertical blanking interval a small unblanking pulse is inserted. This pulse must be filled-in by a blanking pulse or guard pulse from the vertical power output stage which was generated during the flyback period. In this condition the sandcastle output acts as guard detection input and requires a minimum 800  $\mu\text{A}$  input current. This current is sensed during the unblanking period. Vertical blanking is only stopped at the end of the blanking interval when the inserted pulse is present. In this way the picture tube is protected against damage in the event of missing or malfunctioning vertical deflection (see Figs 11, 12 and 13).

## Programmable deflection controller

TDA9151B

### Vertical part (pins 6, 8, 10, 11 and 12)

#### SYNCHRONIZATION PULSE

The  $V_A$  input (pin 12) is a TTL-compatible CMOS input. Pulses at this input have to fulfil the timing requirements as illustrated in Fig.6. For correct detection the minimum pulse width for both the HIGH and LOW period is 2 internal clock periods. For further requirements on minimum pulse width see also Section "De-interlace".

#### VERTICAL PLACE GENERATOR

An overview of the various modes of operation of the vertical place generator is illustrated in Fig.13.

With control bit CPR a compress to 75% of the adjusted values is possible in all modes of operation. This control bit is used to display 16 : 9 standard pictures on 4 : 3 displays. No new adjustment of other corrections, such as corner and S-correction, is required.

With control bit VPR a reduction of the current during clipping, wait and stop modes to 20% of the nominal value can be selected, which will reduce the dissipation in the vertical drive circuits.

#### *Vertical place generator in adaptive mode (MS = logic 0)*

The vertical start-scan data (subaddress 02) determines the vertical placement in the total range of  $64 \times 432$  clock periods in 63 steps. The maximum number of synchronized lines per scan is 910 with an equivalent field frequency of 17.2 or 34.4 Hz for  $f_H = 15625$  or  $31250$  Hz respectively.

The minimum number of synchronized lines per scan is 200 with an equivalent field frequency of 78 or 156 Hz for  $f_H = 15625$  or  $31250$  Hz respectively.

If the  $V_A$  pulse is not present, the number of lines per scan will increase to 910.2. If the LLC is not present the vertical blanking will start within 2  $\mu$ s.

Amplitude control is automatic, with a settling time of 1 to 2 new fields and an accuracy of either 16/12 or 48/12 lines depending on the value of the GBS bit.

Differences in the number of lines per field, as can occur in TXT or in multi-head VTR, will not affect the amplitude setting providing the differences are less than the value selected with GBS. This is called amplitude control guardband. The difference sequence and the difference sequence length are not important.

#### *Vertical place generator in constant slope mode (MS = logic 1)*

In this mode the slope can be programmed directly with a two byte value on subaddress 0C (MSB) and 0D (LSB). When the actual number of lines is greater than the programmed number of lines, the circuit will enter the stop state in which the differential vertical output current remains 100% or drops to 20% (programmable with control bit VPR). The programmed value for the slope is the required number of lines multiplied by 72. The programming limits are; minimum  $200 \times 72$  and maximum  $910 \times 72$ .

A vertical expansion is obtained with a combination of slope data and a programmable wait status, at subaddress 0E. The wait status is selected with control bit MS and can only be activated in the constant slope mode. The wait state is an 8-bit value, programmable from 0 to 255. The actual wait state is one line longer than the programmed value. If blanking is applied during stop and wait status the differential output current will be the same with VPR selected value (20 or 100%).

#### DE-INTERLACE

With de-interlace on (DINT = logic 0), the  $V_A$  pulse is sampled with LLC at a position supplied by control bit DIP (de-interlace phase).

When DIP = logic 0 sampling takes place 42 clock pulses after the leading edge of  $H_A$  ( $T = T_{line} \times 42/432$ ).

When DIP = logic 1 sampling takes place 258 clock pulses after the leading edge of  $H_A$  ( $T = T_{line} \times 258/432$ ).

The distance between the two selectable sampling points is  $(T_{line} \times (258 - 42)/432)$  which is exactly half a line, thus de-interlace is possible in two directions.

The duration of the  $V_A$  pulse must, therefore, be sufficient to enable the  $H_A$  pulse to be caught, in this event an active time of minimum of half a line (see Fig.14 which has an integration time of  $T_{line} \times 1/4$  for the  $V_A$  pulse).

With de-interlace off, the  $V_A$  pulse is sampled with the system clock. The leading edge is detected and used as the vertical reset. Selection of the positive or negative leading edge is achieved by the control bit VAP.

## Programmable deflection controller

TDA9151B

### VERTICAL GEOMETRY PROCESSING

The vertical geometry processing is DC-coupled and therefore independent of field frequency. The external resistive conversion ( $R_{CONV}$ ) at pin 8 sets the reference current for both the vertical and EW geometry processing. A useful range is 100 to 150  $\mu$ A, the recommended value is 120  $\mu$ A.

### VERTICAL OUTPUTS

The vertical outputs  $VOUT_A$  and  $VOUT_B$  on pins 10 and 11 together form a differential current output. The vertical amplitude can be varied over the range 80 to 120% in 63 steps via the I<sup>2</sup>C-bus (subaddress 00). Vertical S-correction is also applied to these outputs and can be set from 0 to 16% by subaddress 01 with a 6-bit resolution.

The vertical off-centre shift (OFCS) shifts the vertical deflection current zero crossing with respect to the EW parabola bottom. The control range is  $-1.5$  to  $+1.5\%$  ( $\pm \frac{1}{8} \times I_8$ ) in 7 steps set by the least significant nibble at subaddress 03.

### EW GEOMETRY PROCESSING

The EW geometry processing is DC coupled and therefore independent of field frequency.  $R_{CONV}$  sets the reference current for both the vertical and EW geometry processing.

The EW output is an ESD-protected single-ended current output.

The EW width/width ratio can be set from 100 to 80% in 63 steps via subaddress 04 and the EW parabola/width ratio from 0 to 20% via subaddress 05. The EW corner/EW parabola ratio has a control range of  $-40$  to 0% in 63 steps via subaddress 06.

The EW trapezium correction can be set from  $-1.5$  to  $+1.5\%$  in 7 steps via the most significant nibble at subaddress 03.

### BULT GENERATOR

The Bult generator makes the EW waveform continuous (see Fig.21).

### Protection input (pin 3)

The protection input (PROT) is a CMOS input.

The input voltage must be EHT scaled and has the following characteristics:

Two modes of protection are available with the aid of control bit PRD.

- With PRD = logic 1 the protection mode is selected, HOUT will be defeated and the PROT bit in the status word is set if the input voltage is above 3.9 V. Thus the deflection stops and EW output current is zero, while the vertical output current is reduced to 20% of the adjusted value. A new start of the circuit is I<sup>2</sup>C-bus controlled with the user software.
- With PRD = logic 0 the detection mode is selected, HOUT will not be defeated and the over voltage information is only written in the PROT status bit and can be read by the I<sup>2</sup>C-bus.

All further actions, such as a write of the LFSS bit, are achieved by the I<sup>2</sup>C-bus. They depend on the configuration used and are defined by user software.

### Flash detection/protection input (pin 9)

The FLASH input is a CMOS input with an internal pull-up current of approximately 8  $\mu$ A.

When a negative-going edge crosses the 0.75 V level a restart will be executed with a soft start of approximately 2000 lines, such as in the soft-start mode. When the function is not used pin 9 can be connected to ground,  $V_{CC}$  or left open-circuit, the internal pull-up current source will prevent any problems. However a hard wired connection to  $V_{CC}$  or ground is recommended when the function is not used.

### EHT compensation (pin 7)

The EHT input is a CMOS input.

The EHT compensation input permits scan amplitude modulation should the EHT supply not be perfect. For correct tracking of the vertical and horizontal deflection the gain of the EW output stage, provided by the ratio  $R_{CONV-EW}/R_{CONV}$ , must be  $\frac{1}{16}V_{scan} \times V_{ref}$  (see Fig.15).

The input for EHT compensation can be derived from an EHT bleeder or from the picture tubes aquadag (subaddress 0B, bit BLDS).

EHT compensation can be set via subaddress 07 in 63 steps allowing a scan modulation range from  $-10$  to  $+9.7\%$ .

# Programmable deflection controller

# TDA9151B

## INTERNAL CIRCUITRY

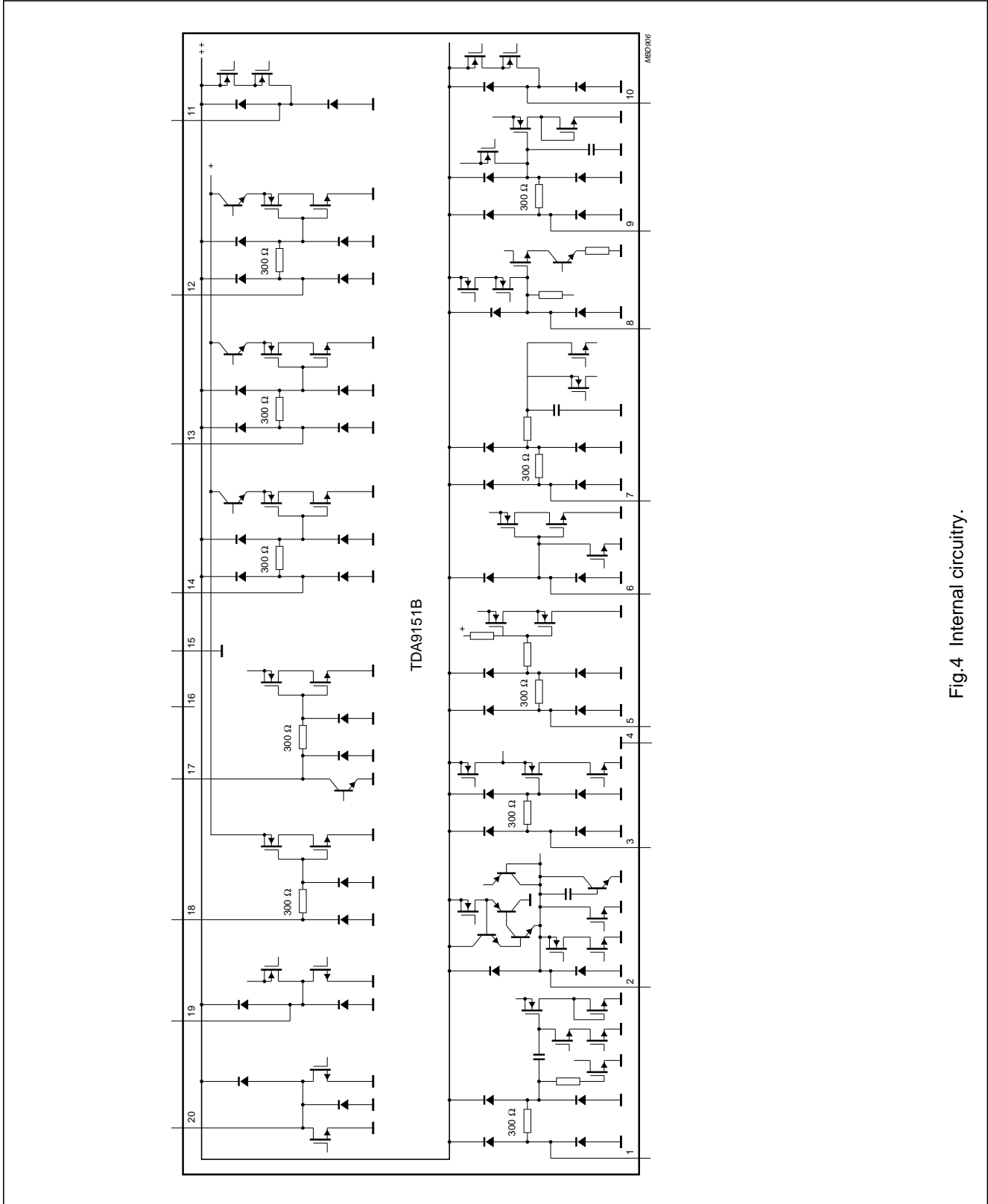

Fig.4 Internal circuitry.



Programmable deflection controller

TDA9151B

TIMING DIAGRAMS

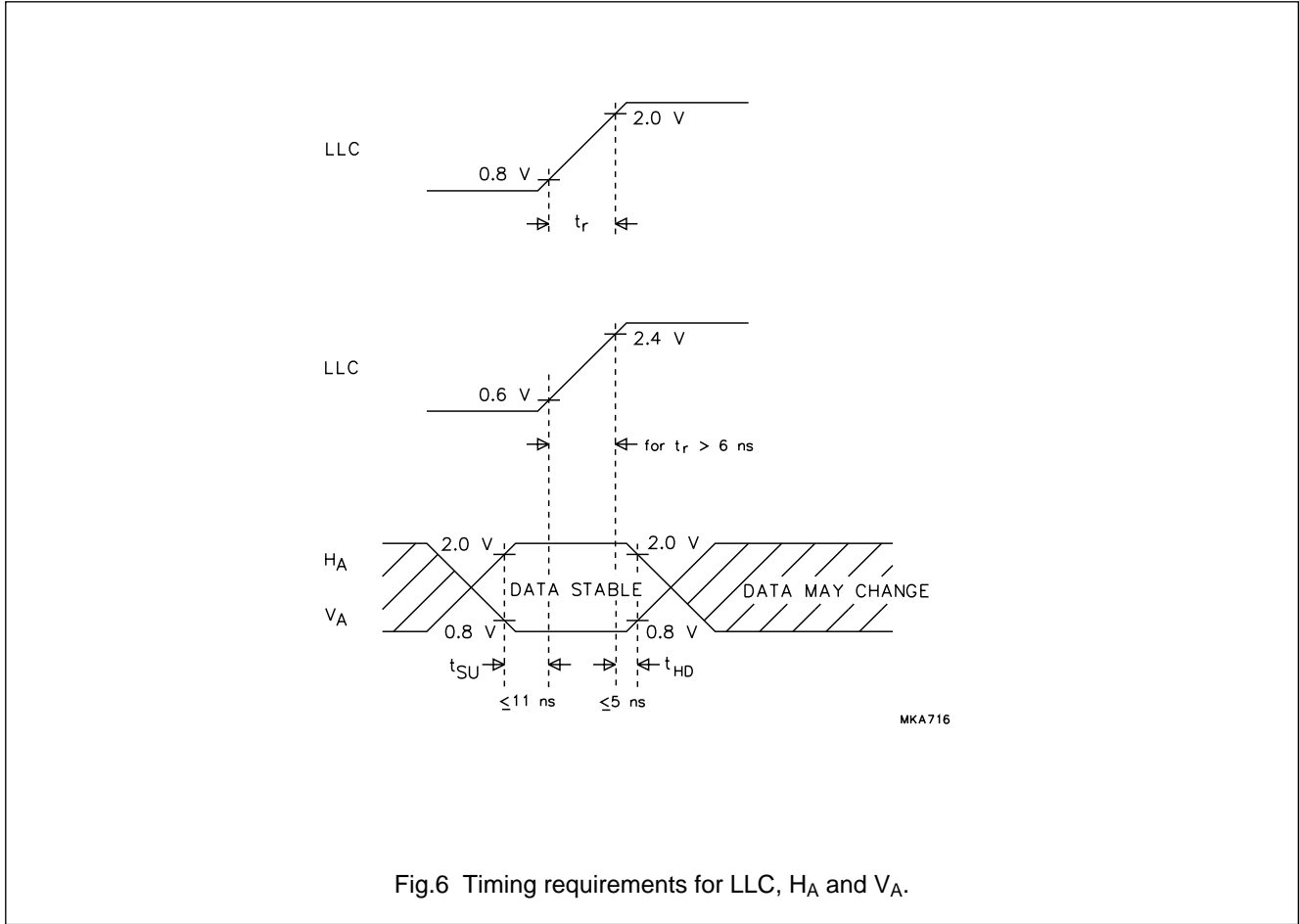

Fig.6 Timing requirements for LLC, HA and VA.

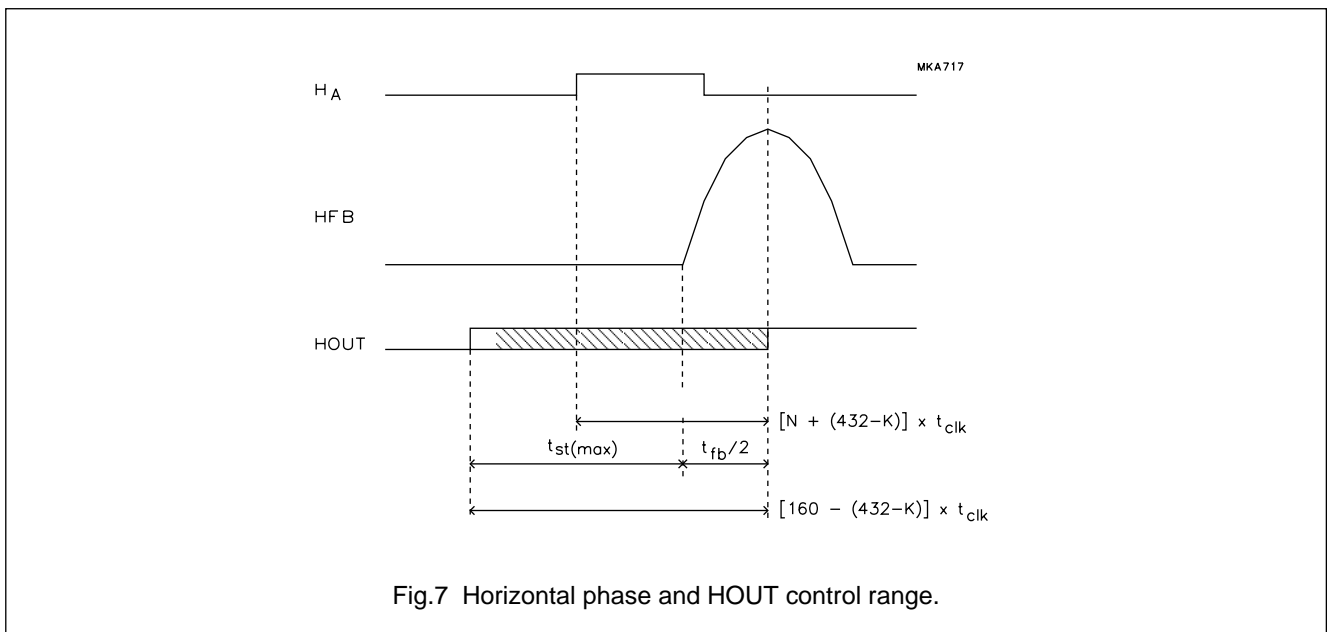

Fig.7 Horizontal phase and HOUT control range.

Programmable deflection controller

TDA9151B

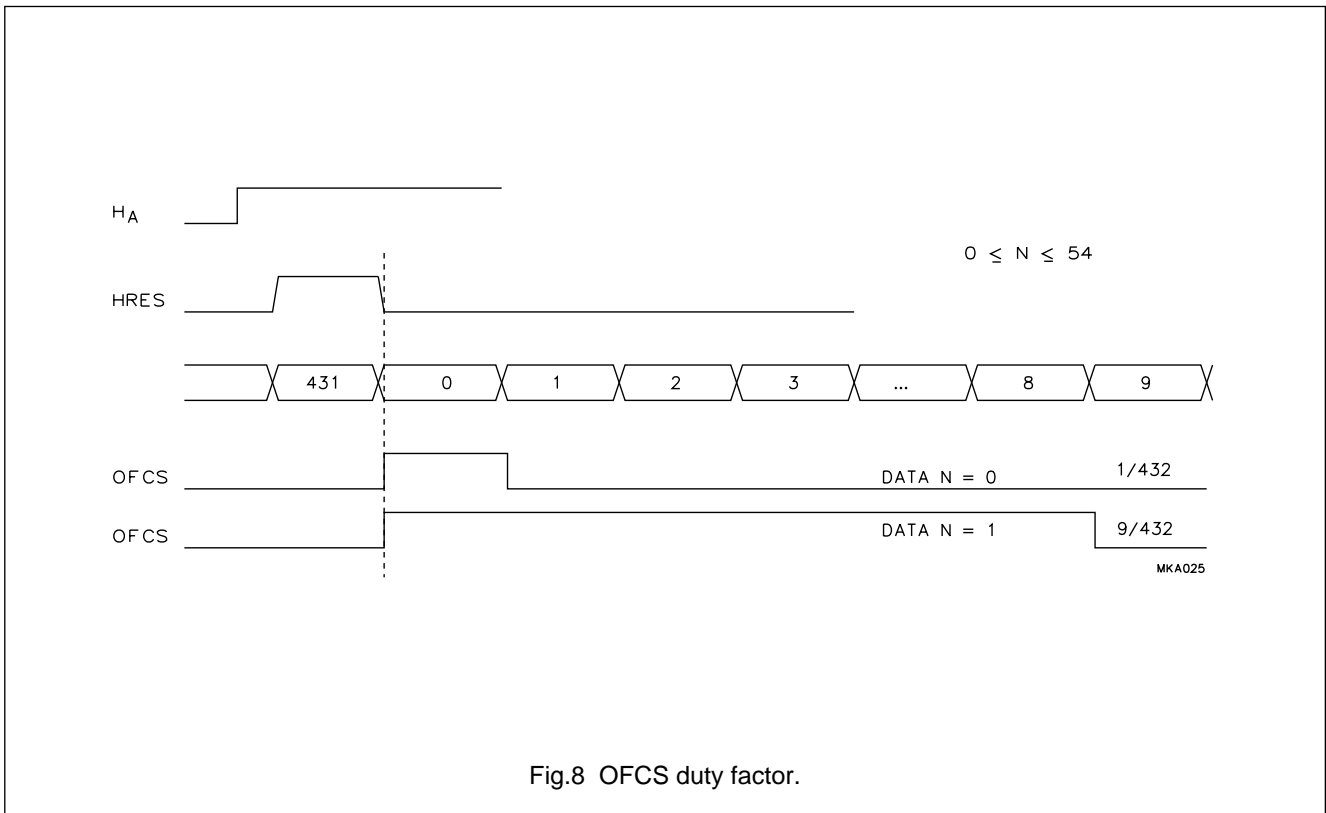

Fig.8 OFCS duty factor.

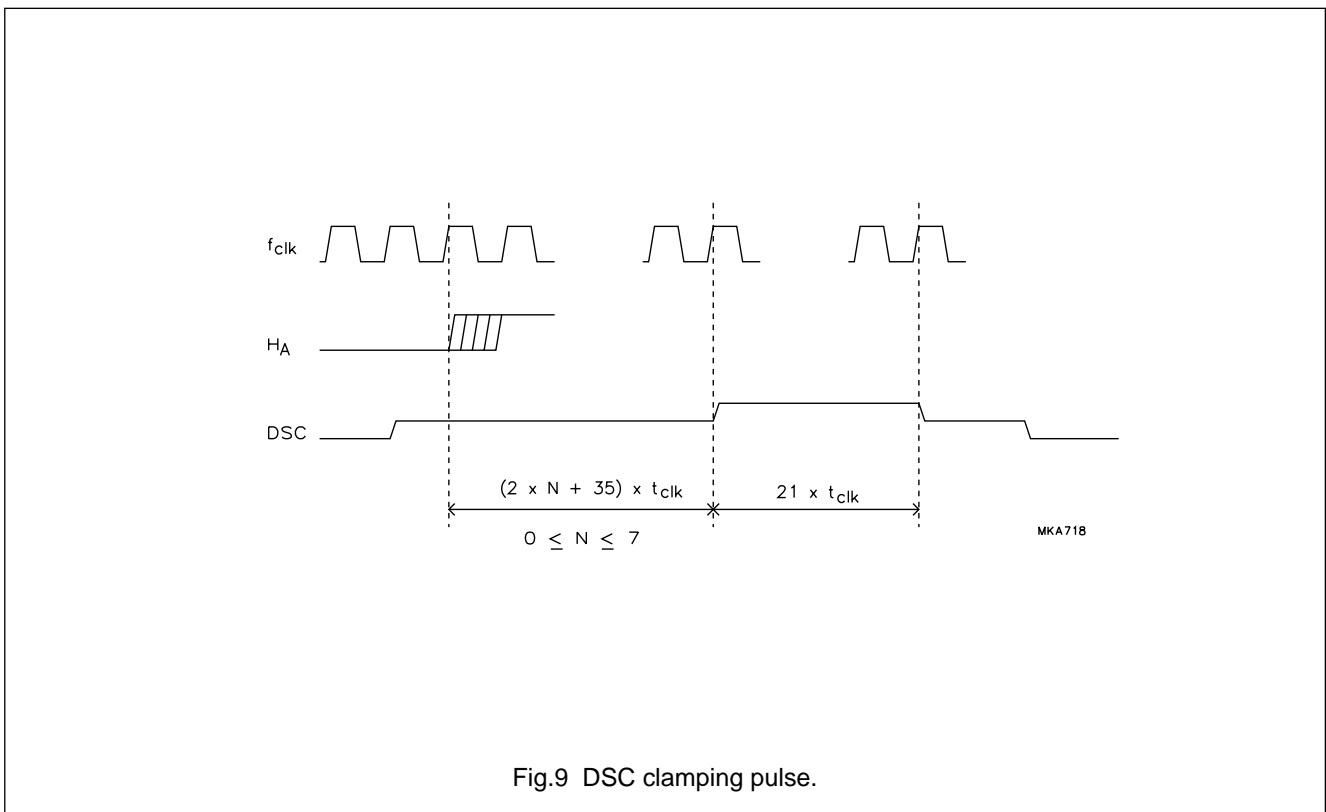

Fig.9 DSC clamping pulse.



Programmable deflection controller

TDA9151B

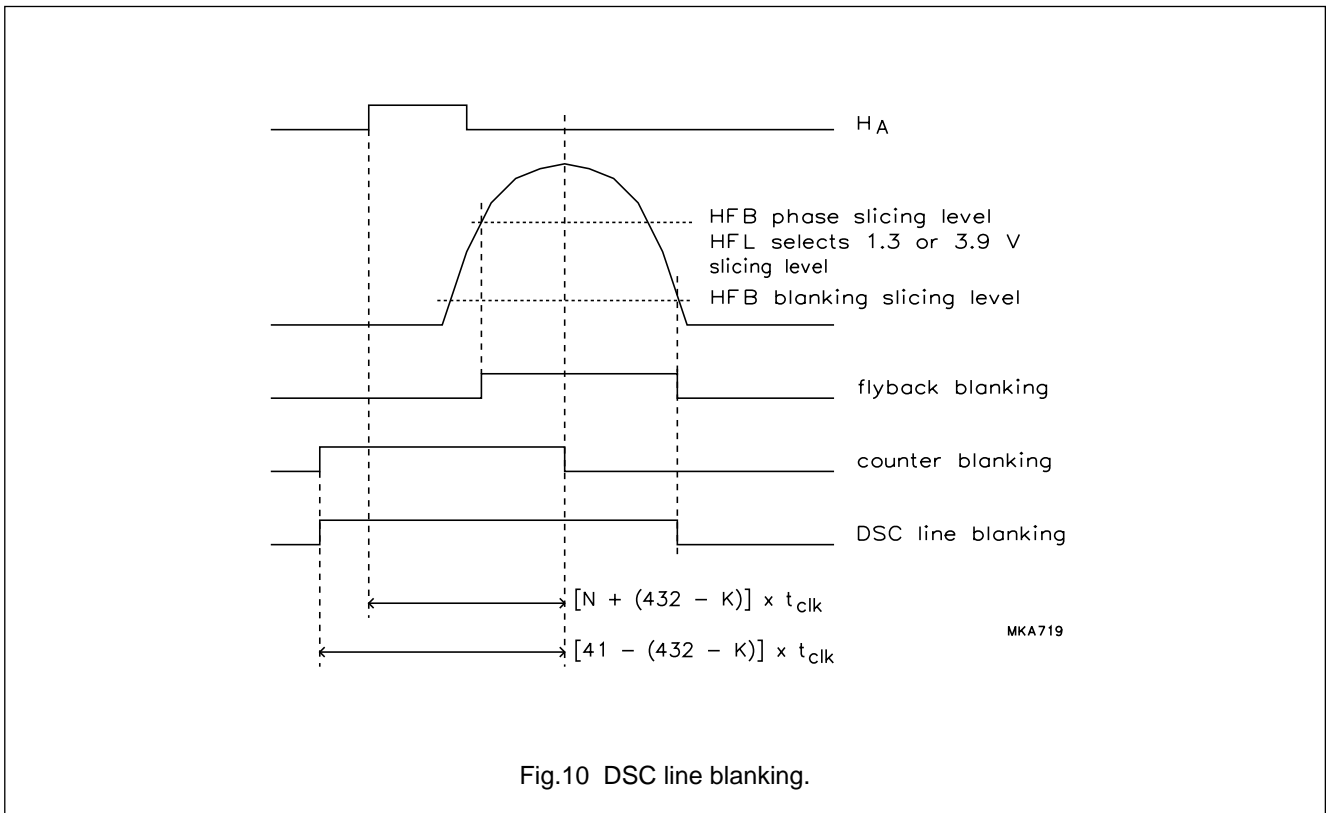

Fig.10 DSC line blanking.

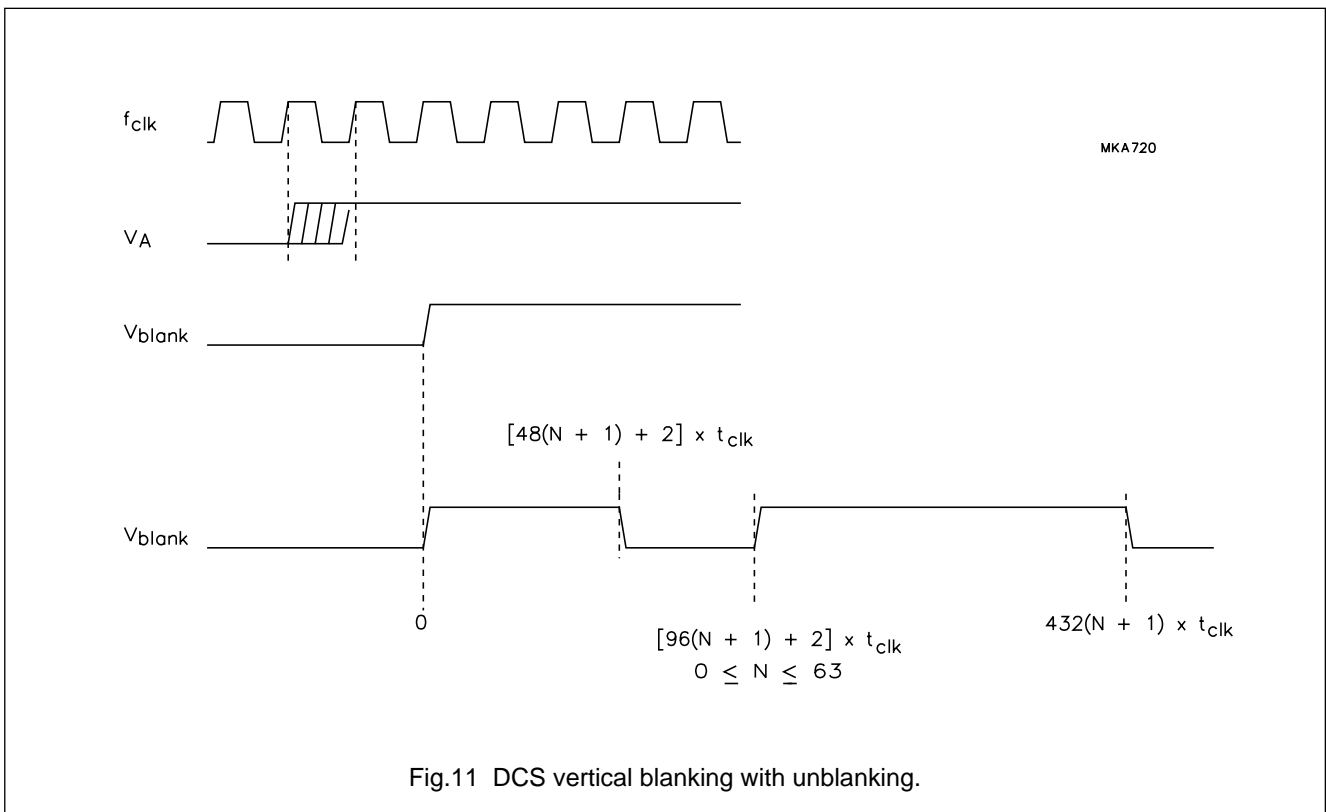
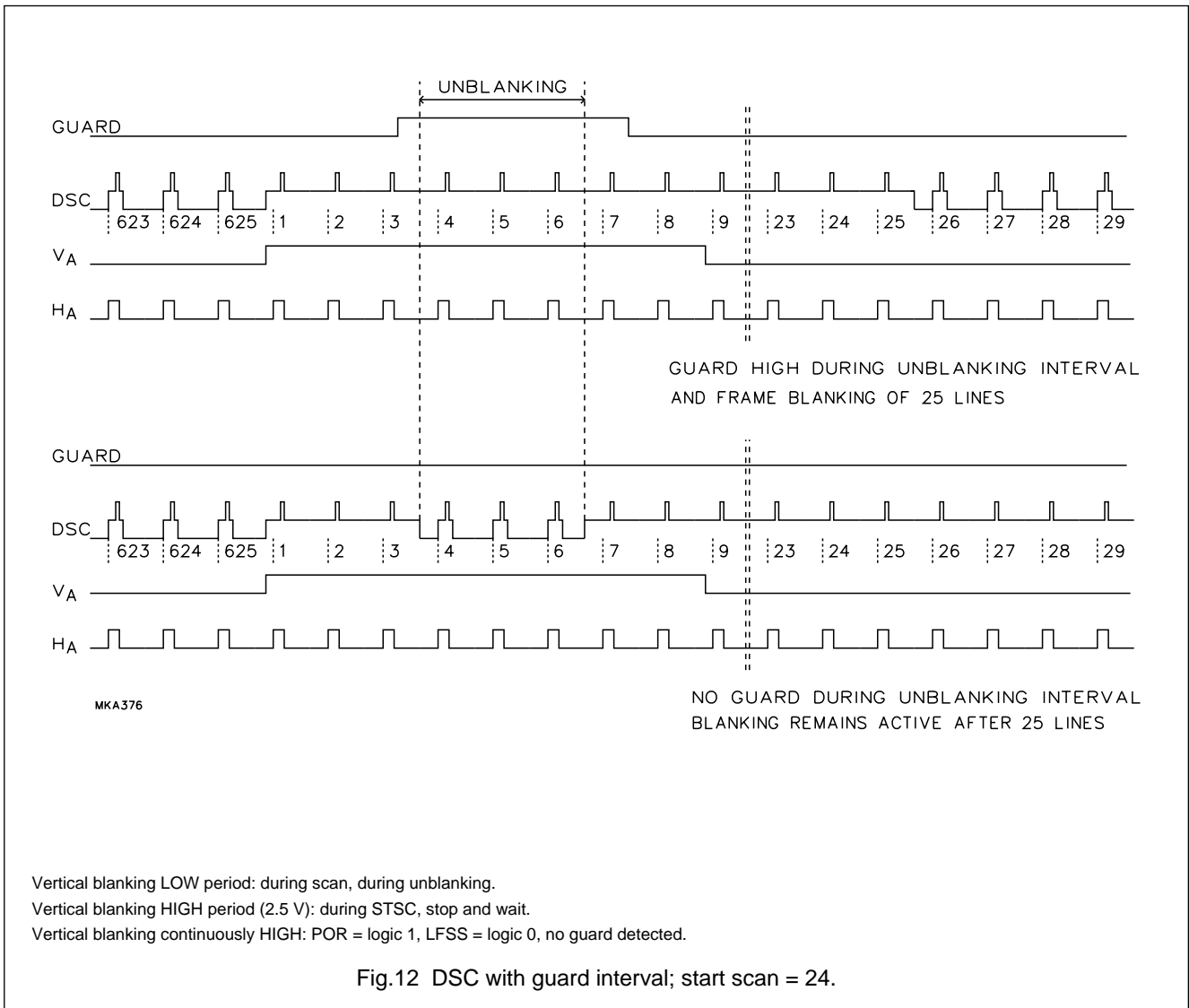

Fig.11 DCS vertical blanking with unblanking.

Programmable deflection controller

TDA9151B



Programmable deflection controller

TDA9151B

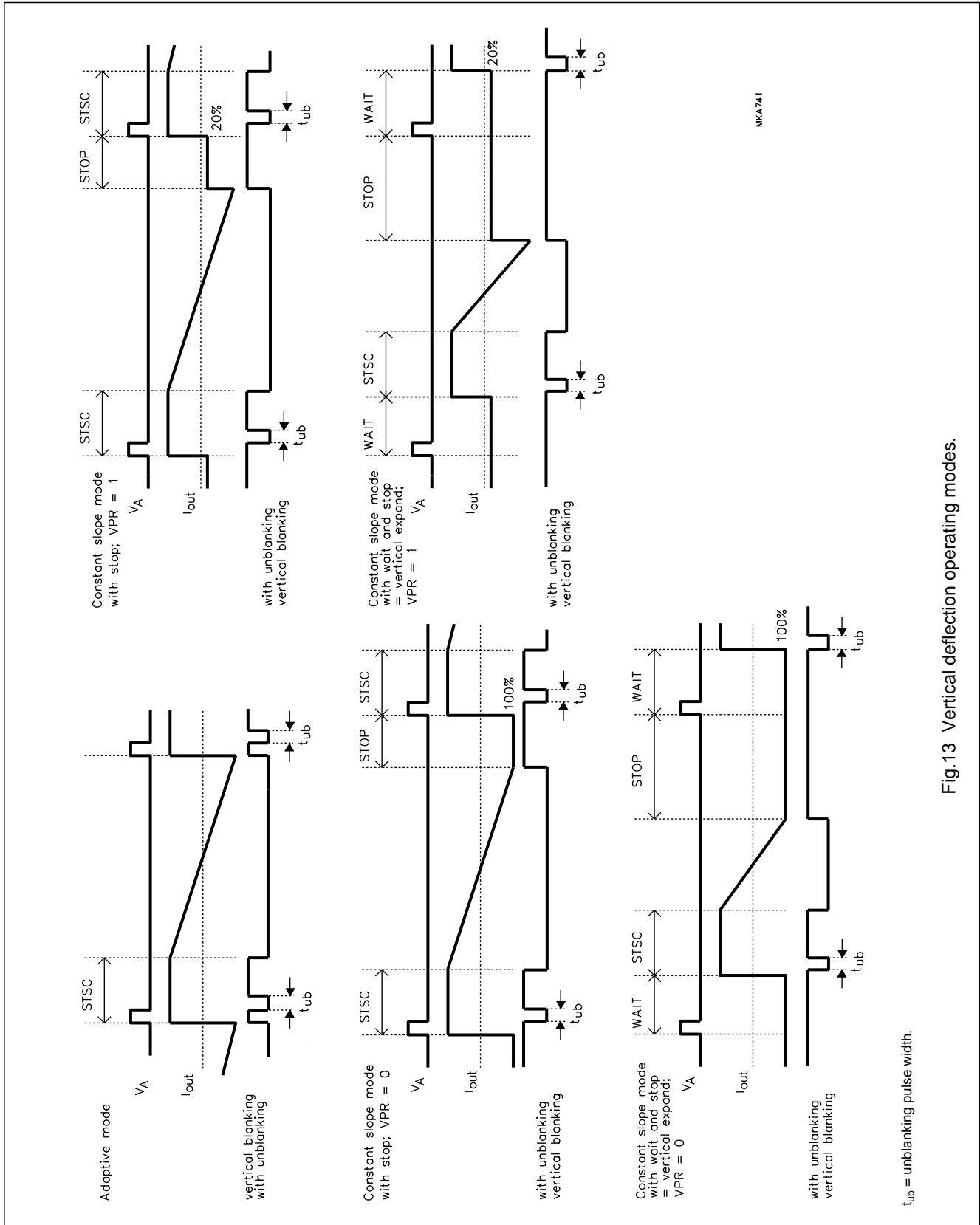
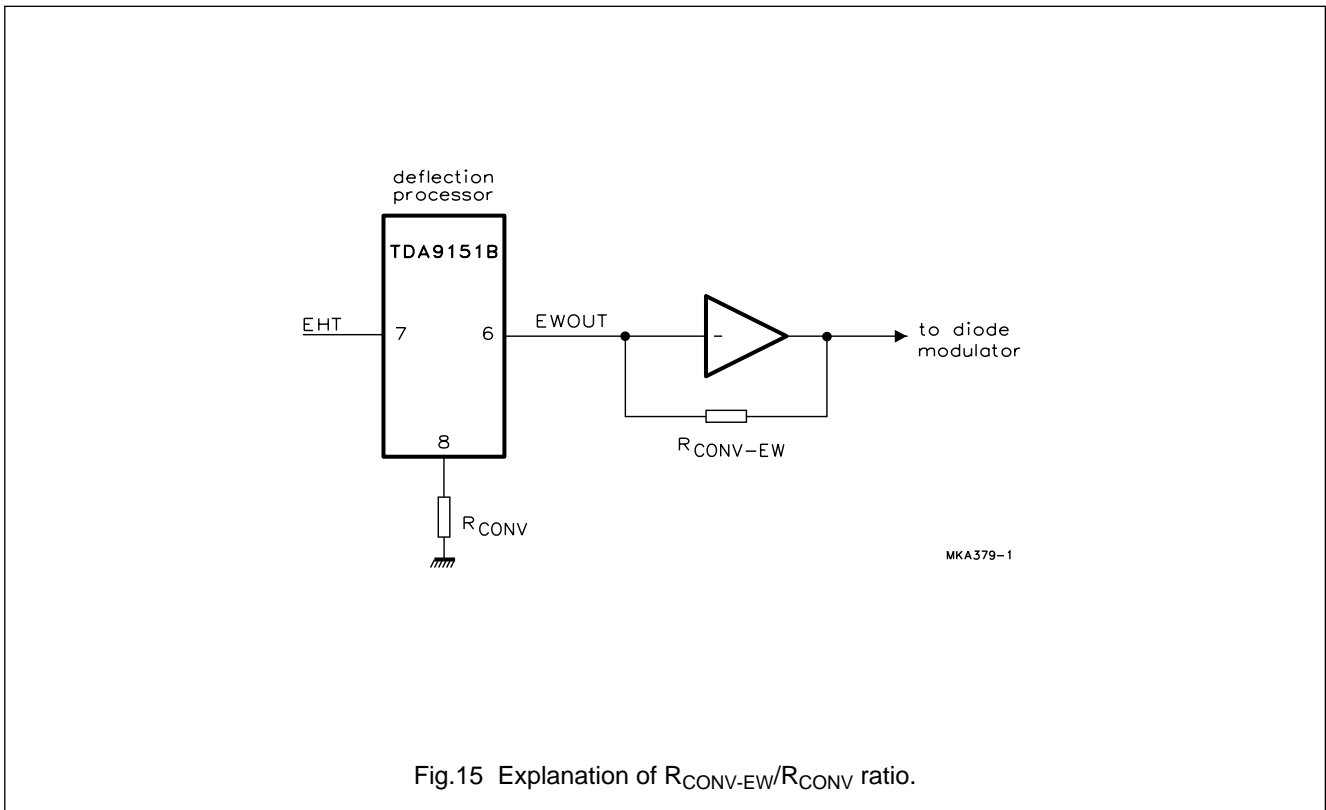
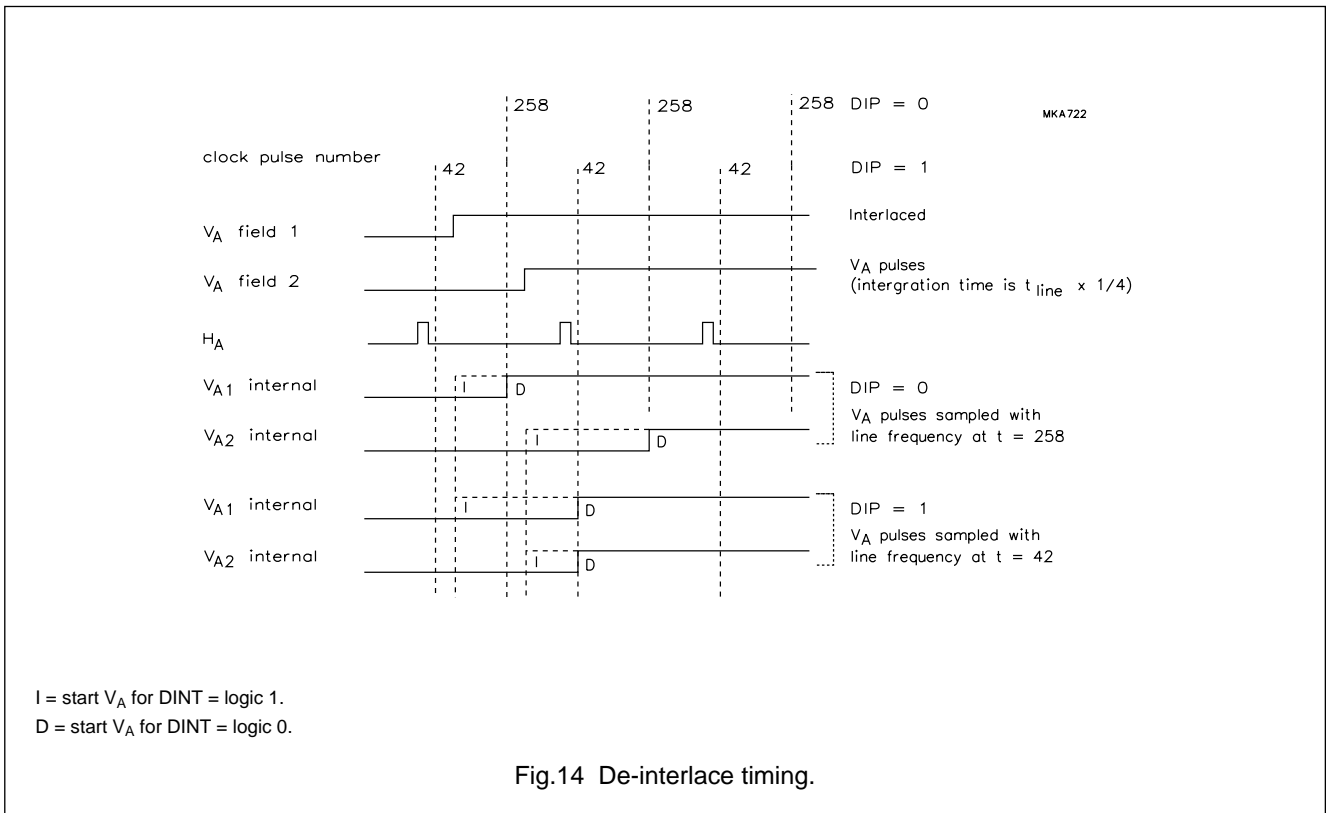

Fig.13 Vertical deflection operating modes.

$t_{ub}$  = unblanking pulse width.

Programmable deflection controller

TDA9151B



## Programmable deflection controller

TDA9151B

**LIMITING VALUES**

In accordance with the Absolute Maximum Rating System (IEC134).

SYMBOL	PARAMETER	MIN.	MAX.	UNIT
$V_{CC}$	supply voltage	-0.5	8.8	V
$I_{CC}$	supply current	-10	+50	mA
$P_{tot}$	total power dissipation	-	500	mW
$T_{stg}$	storage temperature	-65	+150	°C
$T_{amb}$	operating ambient temperature	-25	+70	°C
$V_{supply}$	voltage supplied to pins 1 to 3, 5 to 14 and 17 to 20	-0.5	$V_{CC} + 0.5$	V
$I_{I/O}$	current in or out of any pin except pins 4, 15 and 16	-20	+20	mA
$V_{ESD}$	electrostatic handling for all pins (note 1)	-	±2000	V

**Note**

1. Equivalent to discharging a 100 pF capacitor via a 1.5 kΩ series resistor.

**THERMAL CHARACTERISTICS**

SYMBOL	PARAMETER	VALUE	UNIT
$R_{th\ j-a}$	thermal resistance from junction to ambient in free air	70	K/W

## Programmable deflection controller

## TDA9151B

**CHARACTERISTICS**

$V_{CC} = 8\text{ V}$ ;  $T_{amb} = 25\text{ °C}$ ;  $DGND = AGND = 0\text{ V}$ ; unless otherwise specified.

SYMBOL	PARAMETER	CONDITIONS	MIN.	TYP.	MAX.	UNIT
<b>Supply</b>						
$V_{CC}$	supply voltage		7.2	8.0	8.8	V
$I_{CC}$	supply current	note 1; $f_{clk} = 6.75\text{ MHz}$	–	27	–	mA
$P_{tot}$	total power dissipation		–	220	–	mW
$V_{por}$	power-on reset	POR 1-to-0 transition	–	6.25	7.0	V
		POR 0-to-1 transition	5.0	5.75	–	V
<b>SDA and SCL (pins 17 and 18)</b>						
$V_{17}$	SDA input voltage		0	–	5.5	V
$V_{IL}$	LOW level input voltage (pin 17)		–	–	1.5	V
$V_{IH}$	HIGH level input voltage (pin 17)		3.5	–	–	V
$I_{IL}$	LOW level input current (pin 17)	$V_{17} = V_{SSD}$	–	–	–10	$\mu\text{A}$
$I_{IH}$	HIGH level input current (pin 17)	$V_{17} = V_{CC}$	–	–	10	$\mu\text{A}$
$V_{OL}$	LOW level output voltage (pin 17)	$I_{IL} = 3\text{ mA}$	–	–	0.4	V
$V_{18}$	SCL input voltage		0	–	5.5	V
$V_{IL}$	LOW level input voltage (pin 18)		–	–	1.5	V
$V_{IH}$	HIGH level input voltage (pin 18)		3.5	–	–	V
$I_{IL}$	LOW level input current (pin 18)	$V_{18} = V_{SSD}$	–	–	–10	$\mu\text{A}$
$I_{IH}$	HIGH level input current (pin 18)	$V_{18} = V_{CC}$	–	–	10	$\mu\text{A}$
<b>Line-locked clock and line-locked clock select (pins 14 and 5)</b>						
$V_{IL}$	LOW level input voltage (pin 14)		–	–	0.8	V
$V_{IH}$	HIGH level input voltage (pin 14)		2.0	–	–	V
$I_{14}$	input current	$V_{14} = <5.5\text{ V}$	–10	–	+10	$\mu\text{A}$
$t_r$	rise time		0	–	$\frac{1}{2}t_{LLC}$	
$t_f$	fall time		0	–	$\frac{1}{2}t_{LLC}$	
$\delta_0$	duty factor	LLCS = logic 0; at 1.4 V; note 2	40	50	60	%
$\delta_1$	duty factor	LLCS = logic 1; at 1.4 V; note 2	25	50	75	%
<b>TIMING (PRESCALER ON; <math>f_{clk} = \frac{1}{2}f_{LLC}</math> WHERE <math>f_{clk}</math> = INTERNAL CLOCK)</b>						
$f_{LLC}$	line-locked clock frequency		12.4	–	29.2	MHz
K	line-locked clock frequency ratio between $f_{LLC}$ and $f_H$	H locked	856	864	865	
		H unlocked	–	866	–	
	line-locked clock frequency ratio between $f_{clk}$ and $f_H$	H locked	428	432	432.5	
		H unlocked	–	433	–	

## Programmable deflection controller

## TDA9151B

SYMBOL	PARAMETER	CONDITIONS	MIN.	TYP.	MAX.	UNIT
TIMING (PRESCALER OFF; $f_{clk} = f_{LLC}$ WHERE $f_{clk}$ = INTERNAL CLOCK)						
$f_{LLC}$	line-locked clock frequency		6.2	–	15.5	MHz
K	line-locked clock frequency ratio between $f_{LLC}$ and $f_H$	H locked	428	432	432	
		H unlocked	–	433	–	
	line-locked clock frequency ratio between $f_{clk}$ and $f_H$	H locked	428	432	432	
		H unlocked	–	433	–	
$V_5$	LLCS input voltage		0	–	8.8	V
$V_{IL}$	LOW level input voltage (pin 5)		–	–	1.5	V
$V_{IH}$	HIGH level input voltage (pin 5)		3.5	–	–	V
$I_{IL}$	LOW level input current (pin 5)	$V_5 = V_{SSD}$	–	–	–150	$\mu A$
$I_{IH}$	HIGH level input current (pin 5)	$V_5 = V_{CC}$	–	–	100	$\mu A$
<b>Horizontal part</b>						
INPUT SIGNALS						
<i>H<sub>A</sub> (pin 13)</i>						
$V_{IL}$	LOW level input voltage		–	–	0.8	V
$V_{IH}$	HIGH level input voltage		2.0	–	–	V
$I_{13}$	input current	$V_{13} = 5.5 V$	–10	–	+10	$\mu A$
$t_r$	rise time		0	–	$\frac{1}{2}t_{LLC}$	ns
$t_f$	fall time		0	–	$\frac{1}{2}t_{LLC}$	ns
$t_{WH}$	pulse width HIGH		$2 \times t_{clk}$	–	–	
$t_{WL}$	pulse width LOW		$2 \times t_{clk}$	–	–	
<i>HFB (pin 1)</i>						
$V_{PSL}$	phase slicing level;	FBL = logic 0	3.7	3.9	4.1	V
		FBL = logic 1	1.1	1.3	1.5	V
$V_{blank}$	blanking slicing level		0	0.1	0.2	V
$I_1$	input current		–10	–	+10	$\mu A$
<i>Horizontal phase (delay centre flyback pulse to leading edge of H<sub>A</sub>; where N = horizontal phase data)</i>						
CR	control range		0	$N \times t_{clk}$	$N + (432 - K)$	
	number of steps		–	63	–	
OUTPUT SIGNALS						
<i>HOUT (pin 20)</i>						
$V_{20}$	output voltage	$I_{20} = 0$	0	–	$V_{CC}$	V
$V_{OL}$	LOW level output voltage	$I_{20} = 10 mA$	–	–	0.5	V
$I_{20}$	input current	output off	–10	–	+10	$\mu A$
$\delta$	duty factor	normal operation	51	52	53	%

## Programmable deflection controller

## TDA9151B

SYMBOL	PARAMETER	CONDITIONS	MIN.	TYP.	MAX.	UNIT
<i>Soft start (duty factor controlled line drive)</i>						
$t_W$	initial pulse width soft start		–	–	5	%
CR	control range		5	–	53	%
$t_{ss}$	soft start time		1500	–	3000	lines
<i>Switch-off time to the centre of the flyback pulse</i>						
CR	control range	note 3	0	–	$160 - (432 - K) \times t_{clk}$	
$\Phi$	control sensitivity (loop gain)		400	1000	–	$\mu s/\mu s$
k	correction factor	note 4	–	0.5	–	
$\sigma$	sigma value of phase jitter	note 5	–	750	–	ps
PSRR	power supply rejection ratio		–	–	10	ns/V
<i>Horizontal off-centre shift (pin 19; N = off-centre shift data)</i>						
$V_{19}$	output voltage		0	–	$V_{CC}$	V
$V_{OL}$	LOW level output voltage	$I_{19} = 2 \text{ mA}$	–	–	0.5	V
$V_{OH}$	HIGH level output voltage	$I_{19} = -2 \text{ mA}$	$V_{CC} - 0.5$	–	–	V
$\delta_{(max)}$	maximum duty factor	$N < 54$	1/K	$(8N+1)/K$	425/K	%
$\delta$	duty factor	$N \geq 54$	–	1	–	%
	number of steps		–	54	–	
SANDCASTLE (PIN 2)						
<i>DSC output voltage</i>						
$V_{clamp}$	video clamping voltage		4.0	4.5	5.0	V
$V_{blank}$	horizontal and vertical blanking voltage level		2.0	2.5	3.0	V
$V_{base}$	base voltage level		0	0.5	1.0	V
$I_2$	output current	guard not detected	–1.0	–	+0.35	mA
		guard detected	0.8	–	2.5	mA
$t_r$	rise time		–	60	–	ns
$t_f$	fall time		–	60	–	ns
<i>Clamping pulse (N = clamp pulse shift data)</i>						
$t_W$	clamping pulse width		–	$21 \times t_{clk}$	–	
$t_{clamp}$	clamp pulse shift w.r.t $H_A$		35	$(2N + 35) \times t_{clk}$	49	
	number of steps		–	7	–	
$t_{start}$	start of horizontal blanking before middle of flyback pulse		38	$41 - (432 - K) \times t_{clk}$	41	



## Programmable deflection controller

## TDA9151B

SYMBOL	PARAMETER	CONDITIONS	MIN.	TYP.	MAX.	UNIT
<i>Vertical blanking width (N = vertical start-scan data)</i>						
CR	control range		$1 \times 432t_{\text{clk}}$	$(N + 1) \times 432t_{\text{clk}}$	$64 \times 432t_{\text{clk}}$	
		K = 432	1	–	64	lines
	number of steps		–	63	–	
<i>Guard detection (N = vertical start-scan data)</i>						
t <sub>start</sub>	start interval w.r.t V <sub>A</sub>	no wait	$\{48(N+1) + 2\} \times t_{\text{clk}}$	–	–	
t <sub>stop</sub>	stop interval w.r.t V <sub>A</sub>	no wait	$\{96(N+1) + 2\} \times t_{\text{clk}}$	–	–	
<b>Vertical section</b>						
INPUT SIGNALS (PIN 12; V <sub>A</sub> )						
V <sub>IL</sub>	LOW level input voltage		–	–	0.8	V
V <sub>IH</sub>	HIGH level input voltage		2.0	–	–	V
I <sub>12</sub>	input current	V <sub>12</sub> < 5.5 V	–10	–	+10	μA
t <sub>r</sub>	rise time		0	–	$\frac{1}{2}t_{\text{LLC}}$	ns
t <sub>f</sub>	fall time		0	–	$\frac{1}{2}t_{\text{LLC}}$	ns
t <sub>WH</sub>	pulse width HIGH		$2 \times t_{\text{clk}}$	–	–	
t <sub>WL</sub>	pulse width LOW		$2 \times t_{\text{clk}}$	–	–	
t <sub>WH</sub>	pulse width HIGH	de-interlace mode	$0.5 \times t_{\text{line}}$	–	–	
t <sub>WL</sub>	pulse width LOW	de-interlace mode	$0.5 \times t_{\text{line}}$	–	–	
<i>Vertical place generator in adaptive mode (N = vertical start-scan data)</i>						
CR	control range		$1 \times 432t_{\text{clk}}$	$(N + 1) \times 432t_{\text{clk}}$	$64 \times 432t_{\text{clk}}$	
		K = 432	1	–	64	lines
	number of steps		–	63	–	
L <sub>max</sub>	maximum number of synchronized lines per scan		–	910	–	lines/scan
f <sub>eq</sub>	equivalent field frequency at 910 lines/scan	f <sub>H</sub> = 15625 Hz	–	17.2	–	Hz
		f <sub>H</sub> = 31250 Hz	–	34.4	–	Hz
L <sub>min</sub>	minimum number of synchronized lines per scan		–	200	–	lines/scan
f <sub>eq</sub>	equivalent field frequency at 200 lines/scan	f <sub>H</sub> = 15625 Hz	–	78	–	Hz
		f <sub>H</sub> = 31250 Hz	–	156	–	Hz
CA	amplitude control		–	automatic	–	
CA <sub>g</sub>	amplitude control guardband	GBS = logic 0	–	16/12	–	lines
		GBS = logic 1	–	48/12	–	lines
	settling time		1	1.5	2	new fields

## Programmable deflection controller

## TDA9151B

SYMBOL	PARAMETER	CONDITIONS	MIN.	TYP.	MAX.	UNIT
<i>Vertical place generator in constant slope mode (N = vertical wait data)</i>						
CR	control range		$1 \times 432t_{\text{clk}}$	$(N + 1) \times 432t_{\text{clk}}$	$64 \times 432t_{\text{clk}}$	
		K = 432	1	–	64	lines
	number of steps		–	255	–	
	programmable slope		200	–	910	lines/ scan
	programmable slope data (number of lines $\times$ 72)	2-byte instruction;	$200 \times 72$	–	$910 \times 72$	lines
<i>Vertical geometry processing</i>						
$\Delta I_{(M)}$	vertical differential output current between VOUT <sub>A</sub> and VOUT <sub>B</sub> (peak value)	V <sub>A</sub> = 100%; note 6; I <sub>8</sub> = –120 $\mu$ A	440	475	510	$\mu$ A
D/ $\Delta$ T	drift over temperature range		–	–	$10^{-4}$	K <sup>-1</sup>
	amplitude error due to S-correction setting		–	–	2	%
$\frac{1}{2}(I_{10}+I_{11})$	vertical output signal bias current	I <sub>8</sub> = –120 $\mu$ A	275	325	375	$\mu$ A
I <sub>os</sub>	vertical output offset current	note 7	–	–	1	%
OS/ $\Delta$ T	offset over temperature range		–	–	$10^{-4}$	K <sup>-1</sup>
V <sub>10</sub>	vertical output voltage (pin 10)		0	–	3.9	V
V <sub>11</sub>	vertical output voltage (pin 11)		0	–	3.9	V
CMRR	common mode rejection ratio		–	–	1	%/V
LE	linearity error	adjacent blocks; note 8	–	–	2.0	%
		non-adjacent blocks; note 8	–	–	3.0	%
<i>Vertical amplitude (N = vertical amplitude data)</i>						
CR	control range	note 9	81	–	119	%
			–	63	–	
	number of steps		–	63	–	
<i>Vertical S-correction (N = S-correction data)</i>						
CR	control range	note 9	0	–	15	%
			–	63	–	
	number of steps		–	63	–	
<i>Vertical shift</i>						
CR	control range		$-\frac{1}{8}I_8$	–	$+\frac{1}{8}I_8$	$\mu$ A
			–	7	–	
	number of steps		–	7	–	
<b>EW output (pin 6)</b>						
V <sub>6</sub>	output voltage	note 10	1.0	–	5.5	V
I <sub>6</sub>	output current	I <sub>8</sub> = –120 $\mu$ A; note 11	15	–	930	$\mu$ A
RR	output ripple rejection		–	0.15	1	%/V
D/ $\Delta$ T	output drift over temperature range		–	–	$5.10^{-4}$	K <sup>-1</sup>

## Programmable deflection controller

## TDA9151B

SYMBOL	PARAMETER	CONDITIONS	MIN.	TYP.	MAX.	UNIT
<b>EW WIDTH/WIDTH RATIO</b>						
CR	control range	note 9	100	–	81	%
$I_{eq(typ)}$	typical equivalent output current	$V_6 = 3\text{ V}$	15	–	440	$\mu\text{A}$
	number of steps		–	63	–	
<b>EW PARABOLA/WIDTH RATIO</b>						
CR	control range	note 9	1	–	19	%
$I_{eq(typ)}$	typical equivalent output current	width = 100%	10	–	430	$\mu\text{A}$
		width = 80%	10	–	345	$\mu\text{A}$
	number of steps		–	63	–	
<b>EW CORNER/EW PARABOLA RATIO</b>						
CR	control range	notes 9 and 12	40	–	0	%
$I_{eq(typ)}$	typical equivalent output current	width = 100%	0	–	200	$\mu\text{A}$
		width = 80%	0	–	160	$\mu\text{A}$
	number of steps		–	63	–	
<b>EW TRAPEZIUM CORRECTION</b>						
	EW trapezium/width ratio	note 9	–1.5	–	+1.5	%
	number of steps		–	7	–	
<b>EHT input (pin 7)</b>						
$V_{ref}$	reference voltage	BLDS = logic 1	–	3.9	–	V
		BLDS = logic 0	–	$V_{CC}$	–	V
$V_I$	input voltage w.r.t $V_{ref}$	BLDS = logic 1	–20	0	+20	%
$V_I$	input voltage w.r.t $V_{CC}$	BLDS = logic 0	0	–	$-2V_{ref}$	V
$m_{scan}$	scan modulation		–10	0	+9.7	%
$m_{GC}$	modulation gain control		0	–	1	
	number of steps		–	63	–	
$I_I$	input current		–100	–	+100	nA
<b>R<sub>CONV</sub> input (pin 8)</b>						
$V_O$	output voltage	$I_8 = -120\ \mu\text{A}$	3.7	3.9	4.1	V
$I_8$	current range		–100	–120	–150	$\mu\text{A}$
<b>PROT input (pin 3)</b>						
$V_I$	input voltage		0	–	$V_{CC}$	V
$V_3$	voltage detection level		3.7	3.9	4.1	V
$I_I$	input current		–10	–	+10	$\mu\text{A}$
<b>FLASH detection input (pin 9)</b>						
$V_I$	input voltage		0	–	$V_{CC}$	V
$V_9$	voltage detection level	falling edge	0.5	0.75	1.0	V
H	detection level hysteresis		0.3	0.5	0.8	V
$I_9$	detection pull-up current		–4	–8	–16	$\mu\text{A}$

## Programmable deflection controller

TDA9151B

### Notes to the characteristics

- For all other frequencies the expected supply current will be as shown in Table 6 ( $f_{clk}$  is the internal clock frequency,  $f_{LLC}$  is the internal clock frequency applied to pin 14).
- When the prescaler is on, one in two LLC HIGH periods is omitted.
- For 16 kHz operation the minimum value of the control range is 5.7  $\mu$ s. With  $\frac{1}{2}t_{FB} = 5.7 \mu$ s the minimum storage time is 0 and the maximum is 18  $\mu$ s.  
For 32 kHz operation the minimum value of the control range is 0  $\mu$ s. With  $\frac{1}{2}t_{FB} = 2.85 \mu$ s the minimum storage time is 0 and the maximum is 9  $\mu$ s.
- The k factor is defined as the amount of correction of a phase step. Thus with  $k = 0.5$  a 50% correction of the error takes place each line. The resulting step response now becomes  $k^n$ , with n the line number after the step.
- The sigma value ( $\sigma$ ) of the jitter with respect to LLC ( $H_A$ ) at  $f_H = 32$  kHz and a storage time of 5  $\mu$ s.  
Measurement of  $\sigma$  is carried out during 200 lines in the active scan, the resulting peak-to-peak value is approximately  $6\sigma$ . The visible jitter on the screen will be higher than the peak-to-peak jitter, depending on the deflection stage.
- DAC values: vertical amplitude = 31; EHT = 0; SHIFT = 3; SCOR = 0.
- Value is a percentage of  $I_{10} - I_{11}$ .
- The linearity error is measured without S-correction and based on the same measurement principle as used for the screen. Measuring method: divide the output signal  $I_{10} - I_{11}$  into 22 equal parts, ranging from 1 to 22 inclusive. Measure the value of two succeeding parts called one block starting with part 2 and 3 (block 1) and ending with part 20 and 21 (block 10). Thus part 1 and 22 are unused.

$$\text{Linearity error for adjacent blocks} = \frac{a_k - a_{(k+1)}}{a_{avg}}$$

$$\text{Linearity error for non-adjacent blocks} = \frac{a_{max} - a_{min}}{a_{avg}}$$

Where a = amplitude,  $a_k$  = amplitude block k and  $a_{avg}$  = average amplitude.

- Minimum available range.
- Selection of test mode.  
When the EW output is pulled above  $V_{CC} - 0.5$  V a special test mode is entered in which the prescaler and the clock detector are disabled.
- DAC values: vertical amplitude = 31; EHT = 0.
- The value of -40% (typically 46%) corresponds with data 3F (hexadecimal) and implies maximum 4th order compensation.

**Table 6** Supply current with prescaler on/off.

LLC (MHz)	ON (mA)	OFF (mA)
6.75	note 1	27
13.5	27	38
27	42	note 1

### Note

- Combination not allowed.

Programmable deflection controller

TDA9151B

TEST AND APPLICATION INFORMATION

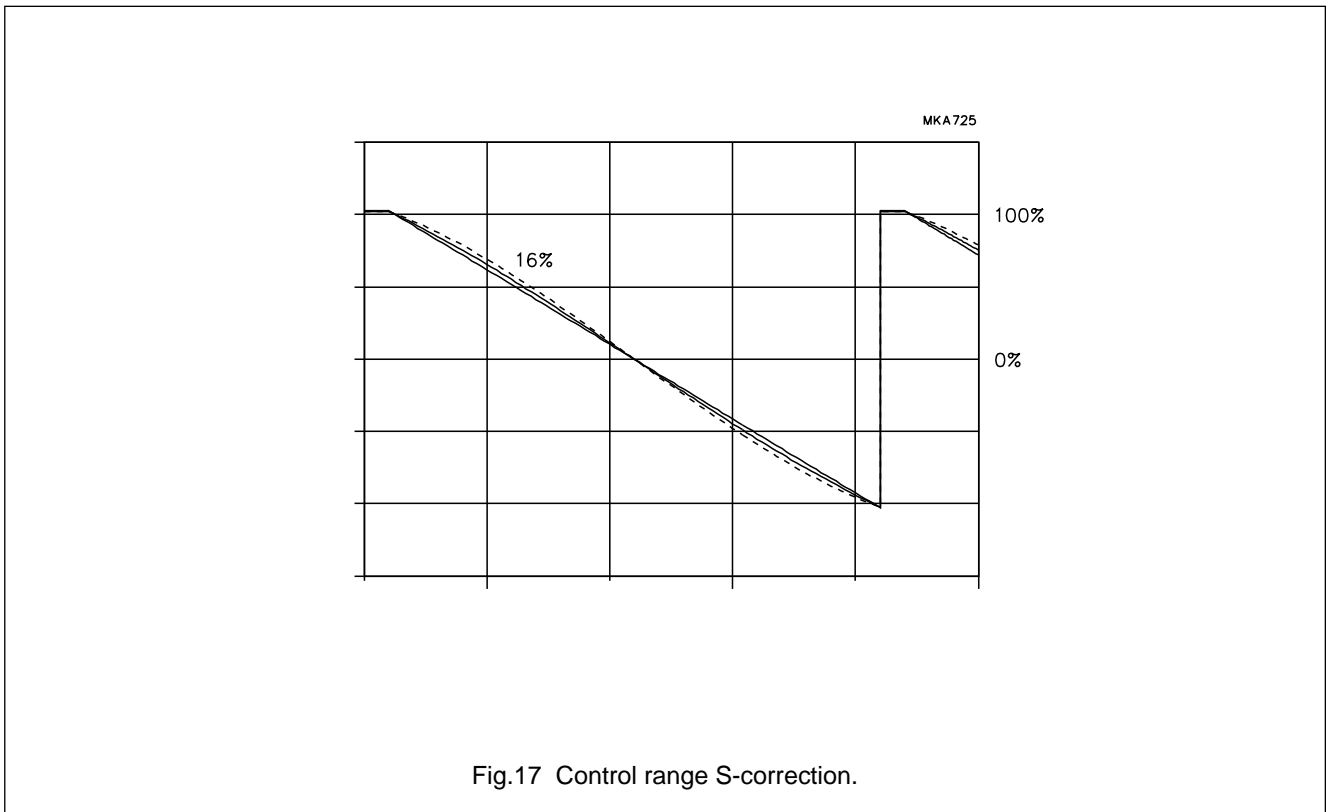
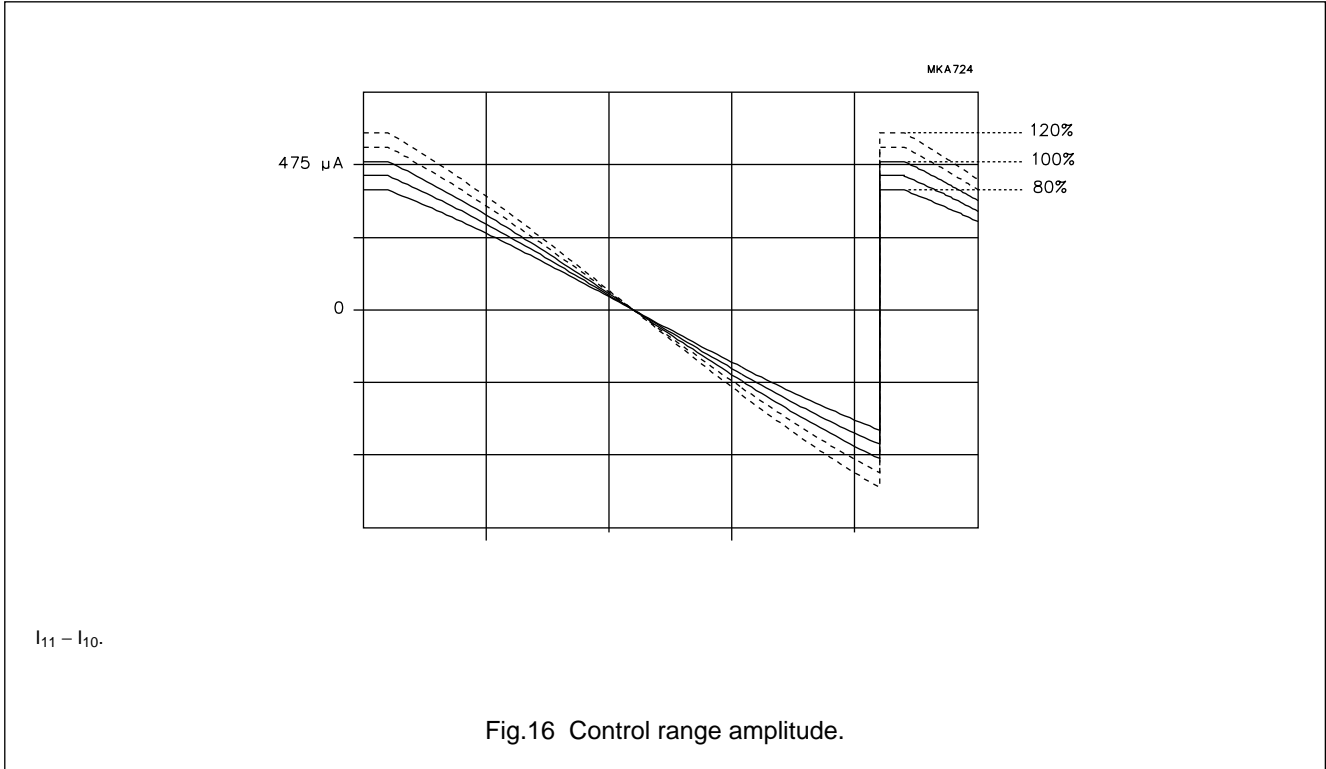

Programmable deflection controller

TDA9151B

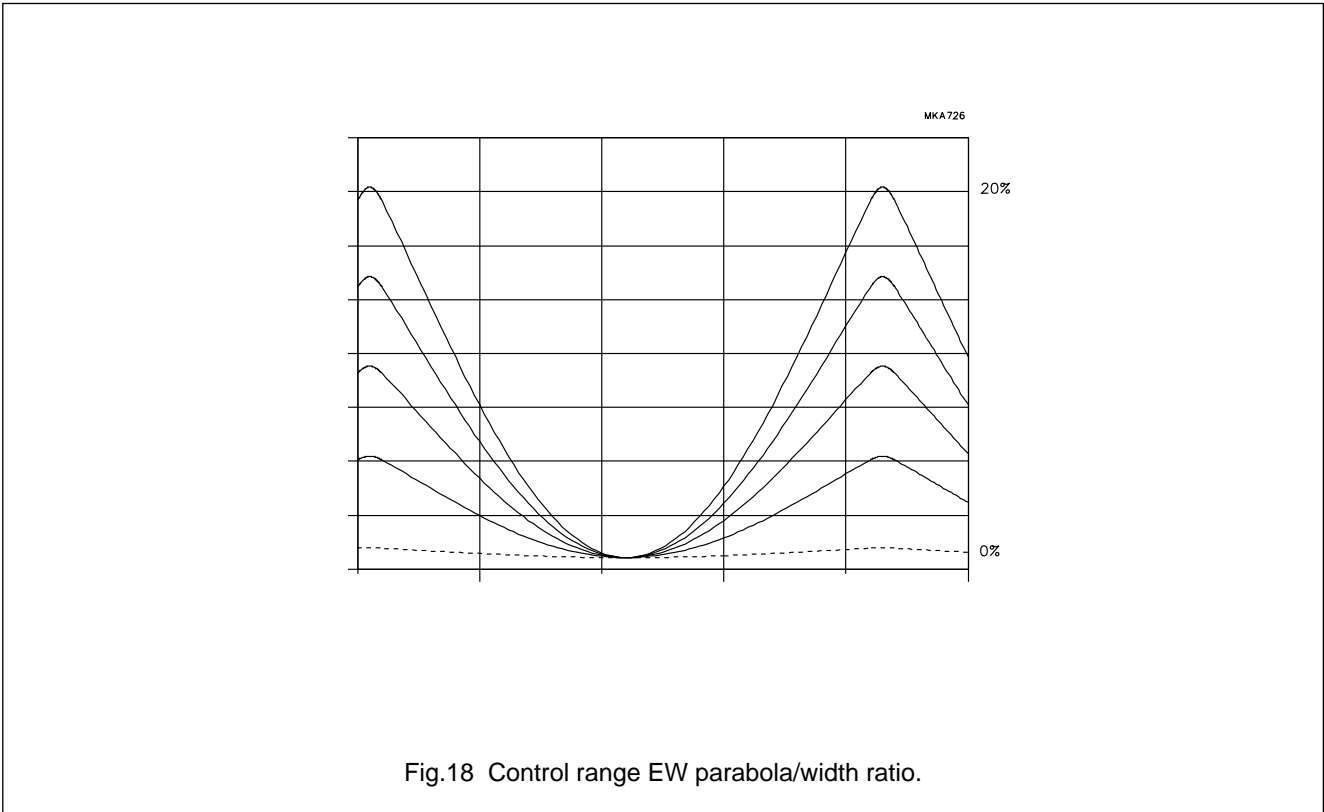

Fig.18 Control range EW parabola/width ratio.

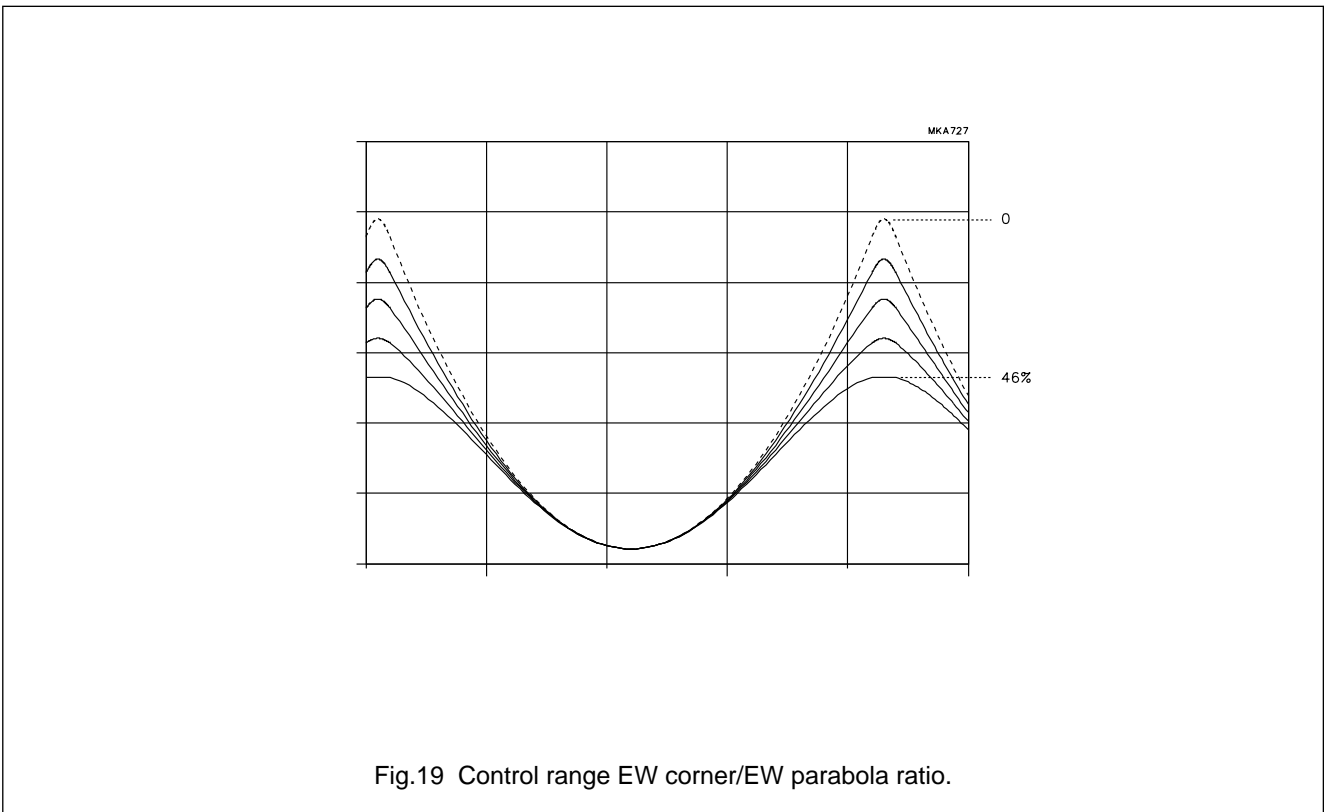

Fig.19 Control range EW corner/EW parabola ratio.

Programmable deflection controller

TDA9151B

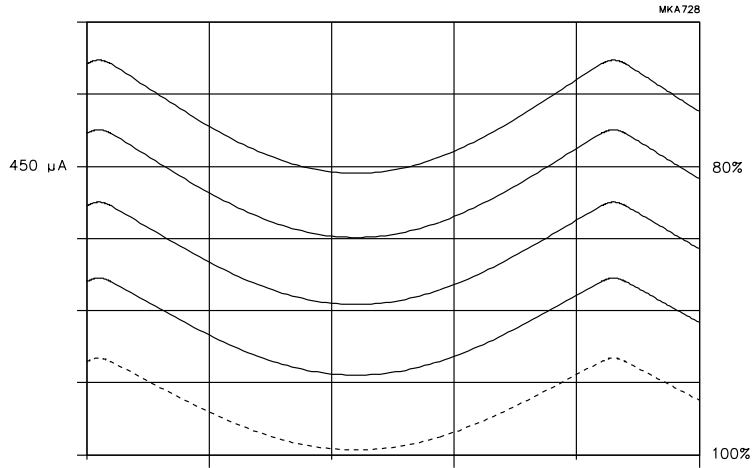

Fig.20 Control range EW width.

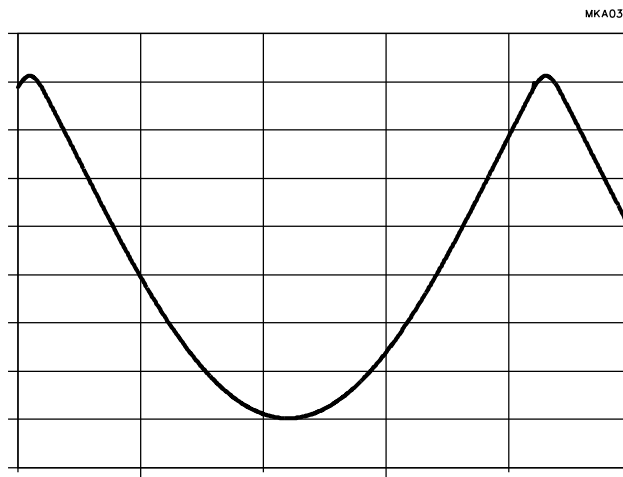
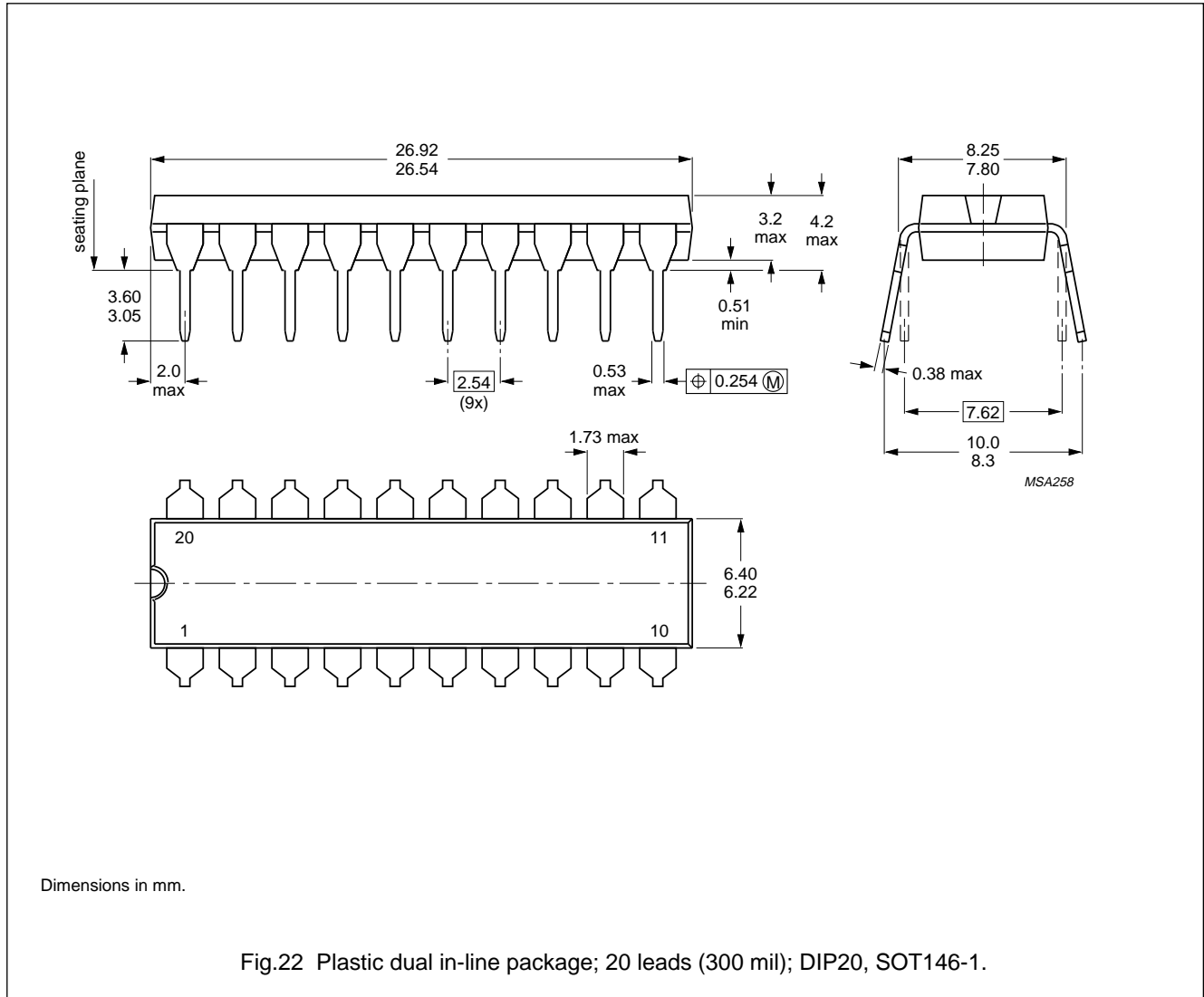

Fig.21 The BULT makes the EW waveform continuous.

Programmable deflection controller

TDA9151B

PACKAGE OUTLINE



**SOLDERING**

**Plastic dual in-line packages**

BY DIP OR WAVE

The maximum permissible temperature of the solder is 260 °C; this temperature must not be in contact with the joint for more than 5 s. The total contact time of successive solder waves must not exceed 5 s.

The device may be mounted up to the seating plane, but the temperature of the plastic body must not exceed the

specified storage maximum. If the printed-circuit board has been pre-heated, forced cooling may be necessary immediately after soldering to keep the temperature within the permissible limit.

**REPAIRING SOLDERED JOINTS**

Apply a low voltage soldering iron below the seating plane (or not more than 2 mm above it). If its temperature is below 300 °C, it must not be in contact for more than 10 s; if between 300 and 400 °C, for not more than 5 s.



## Programmable deflection controller

TDA9151B

### DEFINITIONS

<b>Data sheet status</b>	
Objective specification	This data sheet contains target or goal specifications for product development.
Preliminary specification	This data sheet contains preliminary data; supplementary data may be published later.
Product specification	This data sheet contains final product specifications.
<b>Limiting values</b>	
Limiting values given are in accordance with the Absolute Maximum Rating System (IEC 134). Stress above one or more of the limiting values may cause permanent damage to the device. These are stress ratings only and operation of the device at these or at any other conditions above those given in the Characteristics sections of the specification is not implied. Exposure to limiting values for extended periods may affect device reliability.	
<b>Application information</b>	
Where application information is given, it is advisory and does not form part of the specification.	

### LIFE SUPPORT APPLICATIONS

These products are not designed for use in life support appliances, devices, or systems where malfunction of these products can reasonably be expected to result in personal injury. Philips customers using or selling these products for use in such applications do so at their own risk and agree to fully indemnify Philips for any damages resulting from such improper use or sale.

### PURCHASE OF PHILIPS I<sup>2</sup>C COMPONENTS



Purchase of Philips I<sup>2</sup>C components conveys a license under the Philips' I<sup>2</sup>C patent to use the components in the I<sup>2</sup>C system provided the system conforms to the I<sup>2</sup>C specification defined by Philips. This specification can be ordered using the code 9398 393 40011.

Programmable deflection controller

TDA9151B

---

NOTES

Programmable deflection controller

TDA9151B

---

NOTES

## Philips Semiconductors – a worldwide company

**Argentina:** IEROD, Av. Juramento 1992 - 14.b, (1428)  
BUENOS AIRES, Tel. (541)786 7633, Fax. (541)786 9367

**Australia:** 34 Waterloo Road, NORTH RYDE, NSW 2113,  
Tel. (02)805 4455, Fax. (02)805 4466

**Austria:** Triester Str. 64, A-1101 WIEN, P.O. Box 213,  
Tel. (01)60 101-1236, Fax. (01)60 101-1211

**Belgium:** Postbus 90050, 5600 PB EINDHOVEN, The Netherlands,  
Tel. (31)40 783 749, Fax. (31)40 788 399

**Brazil:** Rua do Rocio 220 - 5<sup>th</sup> floor, Suite 51,  
CEP: 04552-903-SÃO PAULO-SP, Brazil.  
P.O. Box 7383 (01064-970).

Tel. (011)821-2333, Fax. (011)829-1849

**Canada:** PHILIPS SEMICONDUCTORS/COMPONENTS:  
Tel. (800) 234-7381, Fax. (708) 296-8556

**Chile:** Av. Santa Maria 0760, SANTIAGO,  
Tel. (02)773 816, Fax. (02)777 6730

**Colombia:** IPRELENZO LTDA, Carrera 21 No. 56-17,  
77621 BOGOTA, Tel. (571)249 7624/(571)217 4609,  
Fax. (571)217 4549

**Denmark:** Prags Boulevard 80, PB 1919, DK-2300 COPENHAGEN S,  
Tel. (032)88 2636, Fax. (031)57 1949

**Finland:** Sinikalliontie 3, FIN-02630 ESPOO,  
Tel. (9)0-50261, Fax. (9)0-520971

**France:** 4 Rue du Port-aux-Vins, BP317,  
92156 SURESNES Cedex,  
Tel. (01)4099 6161, Fax. (01)4099 6427

**Germany:** PHILIPS COMPONENTS UB der Philips G.m.b.H.,  
P.O. Box 10 63 23, 20043 HAMBURG,  
Tel. (040)3296-0, Fax. (040)3296 213.

**Greece:** No. 15, 25<sup>th</sup> March Street, GR 17778 TAVROS,  
Tel. (01)4894 339/4894 911, Fax. (01)4814 240

**Hong Kong:** PHILIPS HONG KONG Ltd., Components Div.,  
6/F Philips Ind. Bldg., 24-28 Kung Yip St., KWAI CHUNG, N.T.,  
Tel. (852)424 5121, Fax. (852)428 6729

**India:** Philips INDIA Ltd, Components Dept,  
Shivsagar Estate, A Block,  
Dr. Annie Besant Rd. Worli, Bombay 400 018  
Tel. (022)4938 541, Fax. (022)4938 722

**Indonesia:** Philips House, Jalan H.R. Rasuna Said Kav. 3-4,  
P.O. Box 4252, JAKARTA 12950,  
Tel. (021)5201 122, Fax. (021)5205 189

**Ireland:** Newstead, Clonskeagh, DUBLIN 14,  
Tel. (01)640 000, Fax. (01)640 200

**Italy:** PHILIPS COMPONENTS S.r.l.,  
Viale F. Testi, 327, 20162 MILANO,  
Tel. (02)6752.3302, Fax. (02)6752 3300.

**Japan:** Philips Bldg 13-37, Kohnan2-chome, Minato-ku, TOKYO 108,  
Tel. (03)3740 5028, Fax. (03)3740 0580

**Korea:** (Republic of) Philips House, 260-199 Itaewon-dong,  
Yongsan-ku, SEOUL, Tel. (02)794-5011, Fax. (02)798-8022

**Malaysia:** No. 76 Jalan Universiti, 46200 PETALING JAYA,  
SELANGOR, Tel. (03)750 5214, Fax. (03)757 4880

**Mexico:** Philips Components, 5900 Gateway East, Suite 200,  
EL PASO, TX 79905, Tel. 9-5(800)234-7381, Fax. (708)296-8556

**Netherlands:** Postbus 90050, 5600 PB EINDHOVEN, Bldg. VB  
Tel. (040)783749, Fax. (040)788399

**New Zealand:** 2 Wagener Place, C.P.O. Box 1041, AUCKLAND,  
Tel. (09)849-4160, Fax. (09)849-7811

**Norway:** Box 1, Manglerud 0612, OSLO,  
Tel. (022)74 8000, Fax. (022)74 8341

**Pakistan:** Philips Electrical Industries of Pakistan Ltd.,  
Exchange Bldg. ST-2/A, Block 9, KDA Scheme 5, Clifton,  
KARACHI 75600, Tel. (021)587 4641-49,  
Fax. (021)577035/5874546.

**Philippines:** PHILIPS SEMICONDUCTORS PHILIPPINES Inc,  
106 Valero St. Salcedo Village, P.O. Box 2108 MCC, MAKATI,  
Metro MANILA, Tel. (02)810 0161, Fax. (02)817 3474

**Portugal:** PHILIPS PORTUGUESA, S.A.,  
Rua dr. António Loureiro Borges 5, Arquiparque - Miraflores,  
Apartado 300, 2795 LINDA-A-VELHA,  
Tel. (01)14163160/4163333, Fax. (01)14163174/4163366.

**Singapore:** Lorong 1, Toa Payoh, SINGAPORE 1231,  
Tel. (65)350 2000, Fax. (65)251 6500

**South Africa:** S.A. PHILIPS Pty Ltd., Components Division,  
195-215 Main Road Martindale, 2092 JOHANNESBURG,  
P.O. Box 7430 Johannesburg 2000,  
Tel. (011)470-5911, Fax. (011)470-5494.

**Spain:** Balmes 22, 08007 BARCELONA,  
Tel. (03)301 6312, Fax. (03)301 42 43

**Sweden:** Kottbygatan 7, Akalla. S-164 85 STOCKHOLM,  
Tel. (0)8-632 2000, Fax. (0)8-632 2745

**Switzerland:** Allmendstrasse 140, CH-8027 ZÜRICH,  
Tel. (01)488 2211, Fax. (01)481 77 30

**Taiwan:** PHILIPS TAIWAN Ltd., 23-30F, 66, Chung Hsiao West  
Road, Sec. 1. Taipei, Taiwan ROC, P.O. Box 22978,  
TAIPEI 100, Tel. (02)388 7666, Fax. (02)382 4382.

**Thailand:** PHILIPS ELECTRONICS (THAILAND) Ltd.,  
209/2 Sanpavuth-Bangna Road Prakanong,  
Bangkok 10260, THAILAND,  
Tel. (662)398-0141, Fax. (662)398-3319.

**Turkey:** Talatpasa Cad. No. 5, 80640 GÜLTEPE/ISTANBUL,  
Tel. (0212)279 2770, Fax. (0212)269 3094

**United Kingdom:** Philips Semiconductors LTD.,  
276 Bath road, Hayes, MIDDLESEX UB3 5BX,  
Tel. (081)73050000, Fax. (081)7548421

**United States:** 811 East Arques Avenue, SUNNYVALE,  
CA 94088-3409, Tel. (800)234-7381, Fax. (708)296-8556

**Uruguay:** Coronel Mora 433, MONTEVIDEO,  
Tel. (02)70-4044, Fax. (02)92 0601

**For all other countries apply to:** Philips Semiconductors,  
International Marketing and Sales, Building BE-p,  
P.O. Box 218, 5600 MD, EINDHOVEN, The Netherlands,  
Telex 35000 phtcnl, Fax. +31-40-724825

SCD33 © Philips Electronics N.V. 1994

All rights are reserved. Reproduction in whole or in part is prohibited without the prior written consent of the copyright owner.

The information presented in this document does not form part of any quotation or contract, is believed to be accurate and reliable and may be changed without notice. No liability will be accepted by the publisher for any consequence of its use. Publication thereof does not convey nor imply any license under patent- or other industrial or intellectual property rights.

Printed in The Netherlands

533061/1500/02/pp36  
Document order number:

Date of release: July 1994  
9397 737 90011

# Philips Semiconductors



# PHILIPS