

**APPLICATIONS**

- High Power Inverters And Choppers
- UPS
- Railway Traction
- Induction Heating
- AC Motor Drives
- Cycloconverters

**KEY PARAMETERS**

$V_{DRM}$	<b>1400V</b>
$I_{T(RMS)}$	<b>700A</b>
$I_{TSM}$	<b>9000A</b>
$dV/dt$	<b>300V/<math>\mu</math>s</b>
$dl/dt$	<b>500A/<math>\mu</math>s</b>
$t_q$	<b>20<math>\mu</math>s</b>

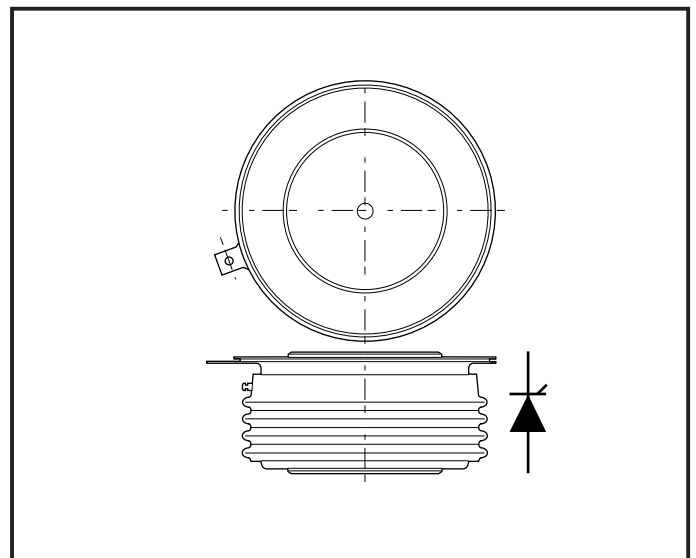
**FEATURES**

- Double Side Cooling
- High Surge Capability
- High Voltage

**VOLTAGE RATINGS**

Type Number	Repetitive Peak Voltages		Conditions
	$V_{DRM}$	$V_{RRM}$	
TF666 14A	1400		$V_{RSM} = V_{RRM} + 100V$  $I_{DRM} = I_{RRM} = 35mA$  at $V_{RRM}$ or $V_{DRM}$ & $T_{vj}$
TF666 12A	1200		
TF666 10A	1000		
TF666 08A	800		
TF666 06A	600		

Lower voltage grades available.



Outline type code: MU171.

See Package Details for further information.

**CURRENT RATINGS**

Symbol	Parameter	Conditions	Max.	Units
$I_{T(AV)}$	Mean on-state current	Half sinewave, 50Hz, $T_{case} = 80^{\circ}C$	446	A
$I_{T(RMS)}$	RMS value	Half sinewave, 50Hz, $T_{case} = 80^{\circ}C$	700	A

# TF666..A

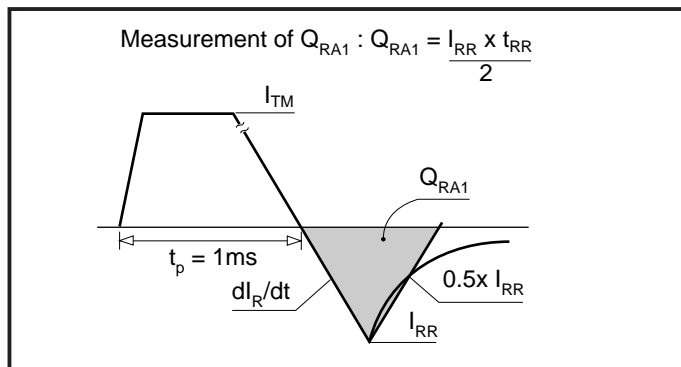
## SURGE RATINGS

Symbol	Parameter	Conditions	Max.	Units
$I_{TSM}$	Surge (non-repetitive) on-state current	10ms half sine; $V_R = 0\% V_{RRM}$ , $T_j = 125^\circ\text{C}$	9.0	kA
$I^2t$	$I^2t$ for fusing	10ms half sine; $V_R = 0\% V_{RRM}$ , $T_j = 125^\circ\text{C}$	$405.0 \times 10^3$	$\text{A}^2\text{s}$

## THERMAL AND MECHANICAL DATA

Symbol	Parameter	Conditions		Min.	Max.	Units
$R_{th(j-c)}$	Thermal resistance - junction to case	Double side cooled	dc	-	0.05	$^\circ\text{C/W}$
		Single side cooled	Anode dc	-	0.095	$^\circ\text{C/W}$
			Cathode dc	-	0.11	$^\circ\text{C/W}$
$R_{th(c-h)}$	Thermal resistance - case to heatsink	Clamping force 10.0kN with mounting compound		-	0.01	$^\circ\text{C/W}$
				-	0.02	$^\circ\text{C/W}$
$T_{vj}$	Virtual junction temperature	On-state (conducting)		-	125	$^\circ\text{C}$
		Reverse (blocking)		-	125	$^\circ\text{C}$
$T_{stg}$	Storage temperature range			-40	150	$^\circ\text{C}$
-	Clamping force			9.5	10.5	kN

## MEASUREMENT OF RECOVERED CHARGE - $Q_{RA1}$



## DYNAMIC CHARACTERISTICS

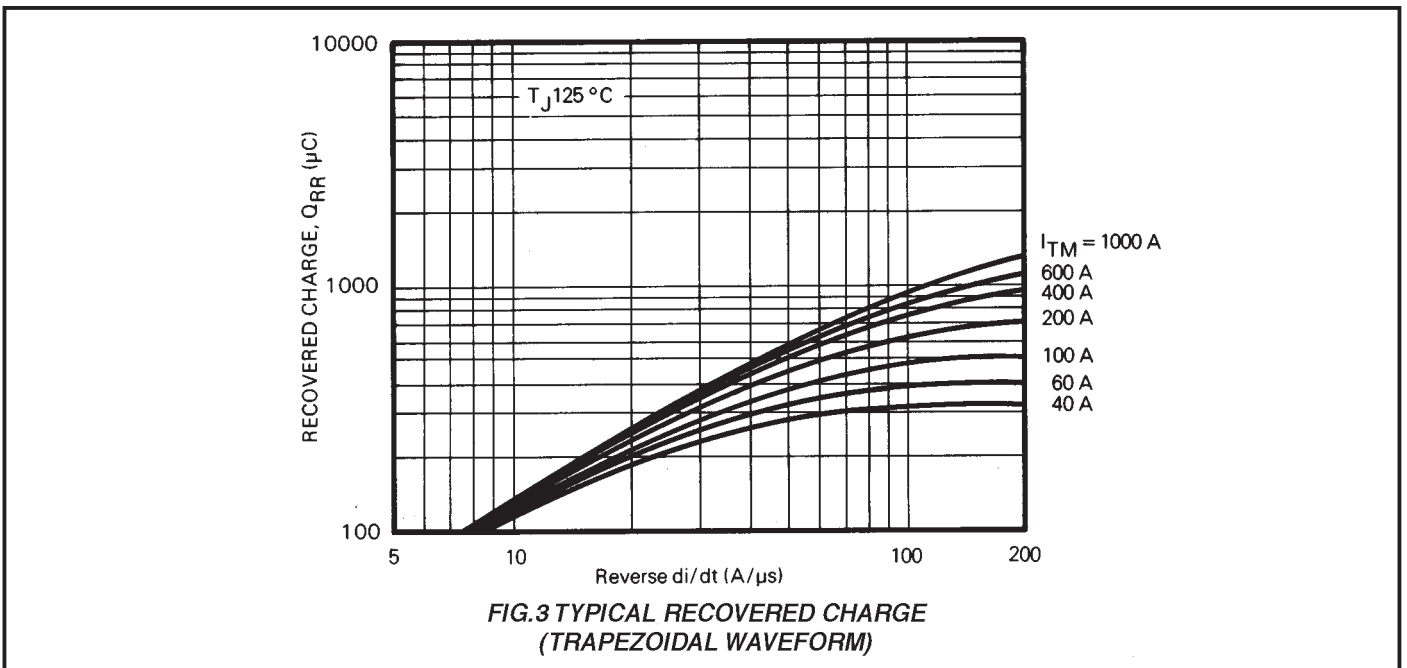
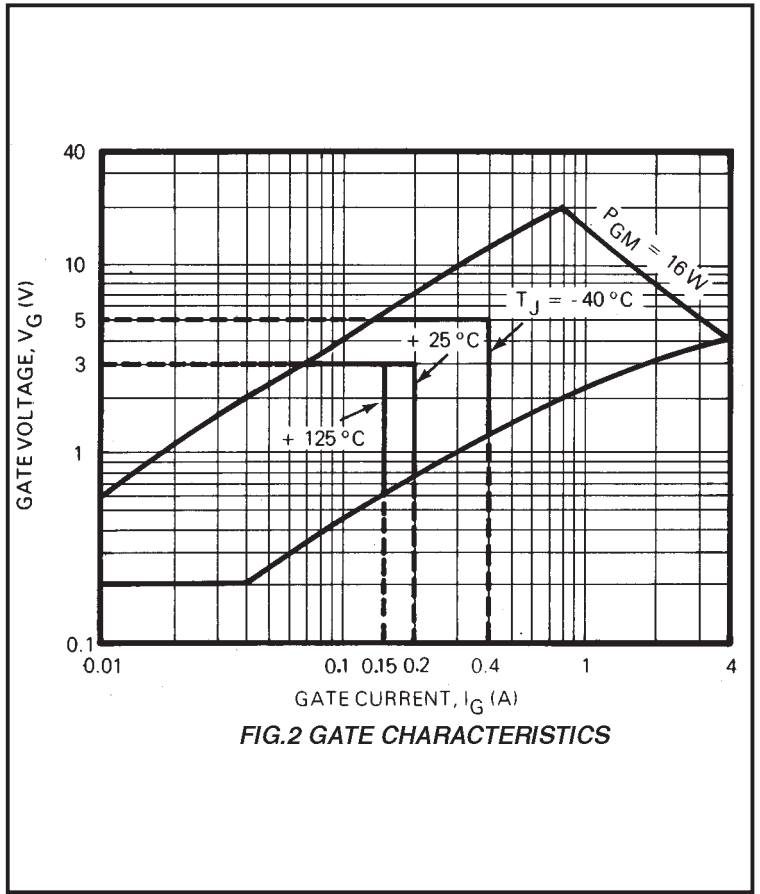
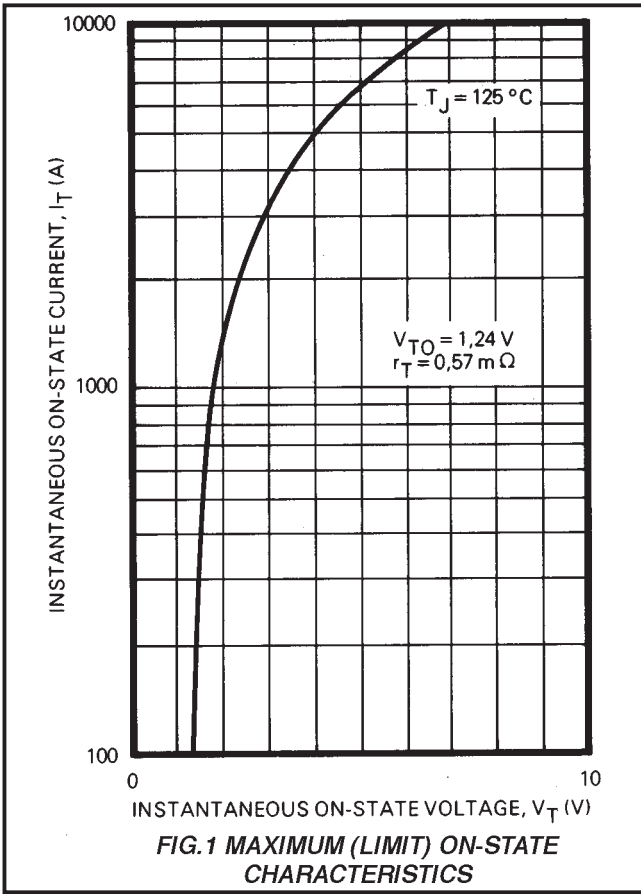
Symbol	Parameter	Conditions	Min.	Max.	Units	
$V_{TM}$	Maximum on-state voltage	At 1500A peak, $T_{case} = 25^{\circ}C$	-	2.1	V	
$I_{RRM}/I_{DRM}$	Peak reverse and off-state current	At $V_{RRM}/V_{DRM}$ , $T_{case} = 125^{\circ}C$	-	35	mA	
dV/dt	Maximum linear rate of rise of off-state voltage	Linear to 60% $V_{DRM}$ , $T_j = 125^{\circ}C$ , Gate open circuit	-	300	V/ $\mu$ s	
dI/dt	Rate of rise of on-state current	Gate source 20V, 20 $\Omega$	Repetitive 50Hz	-	500	A/ $\mu$ s
		$t_r \leq 0.5\mu$ s, $T_j = 125^{\circ}C$	Non-repetitive	-	800	A/ $\mu$ s
$V_{T(TO)}$	Threshold voltage	At $T_{vj} = 125^{\circ}C$	-	1.24	V	
$r_T$	On-state slope resistance	At $T_{vj} = 125^{\circ}C$	-	0.57	m $\Omega$	
$t_{gd}$	Delay time	$T_j = 25^{\circ}C$ , $I_T = 50A$ , $V_D = 300V$ , $I_G = 1A$ , $dI/dt = 50A/\mu$ s, $dI_G/dt = 1A/\mu$ s	-	1.5*	$\mu$ s	
$t_{(ON)TOT}$	Total turn-on time		-	3*	$\mu$ s	
$I_H$	Holding current	$T_j = 25^{\circ}C$ , $I_{TM} = 1A$ , $V_D = 12V$	-	80*	mA	
$I_L$	Latching current	$T_j = 25^{\circ}C$ , $I_G = 0.5A$ , $V_D = 12V$	-	500*	mA	
$t_q$	Turn-off time	$T_j = 125^{\circ}C$ , $I_T = 250A$ , $V_R = 50V$ , $dV/dt = 20V/\mu$ s (Linear to 60% $V_{DRM}$ ), $dI_R/dt = 50A/\mu$ s, Gate open circuit	$t_q$ code: A	-	20	$\mu$ s

\*Typical value.

## GATE TRIGGER CHARACTERISTICS AND RATINGS

Symbol	Parameter	Conditions	Typ.	Max.	Units
$V_{GT}$	Gate trigger voltage	$V_{DRM} = 12V$ , $T_{case} = 25^{\circ}C$ , $R_L = 6\Omega$	-	3.0	V
$I_{GT}$	Gate trigger current	$V_{DRM} = 12V$ , $T_{case} = 25^{\circ}C$ , $R_L = 6\Omega$	-	200	mA
$V_{GD}$	Gate non-trigger voltage	At $V_{DRM}$ , $T_{case} = 125^{\circ}C$ , $R_L = 1k\Omega$	-	0.2	V
$V_{RGM}$	Peak reverse gate voltage		-	5.0	V
$I_{FGM}$	Peak forward gate current	Anode positive with respect to cathode	-	4	A
$P_{GM}$	Peak gate power		-	16	W
$P_{G(AV)}$	Mean gate power		-	3	W

CURVES



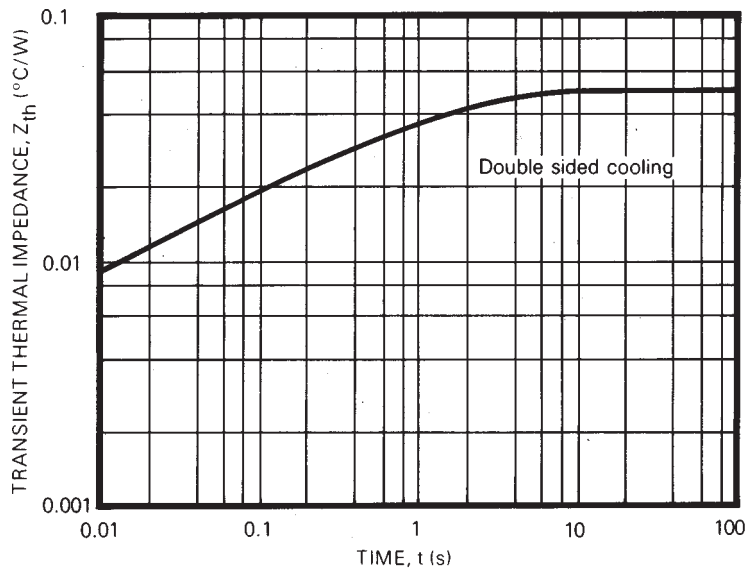


FIG. 4 TRANSIENT THERMAL IMPEDANCE - JUNCTION TO CASE

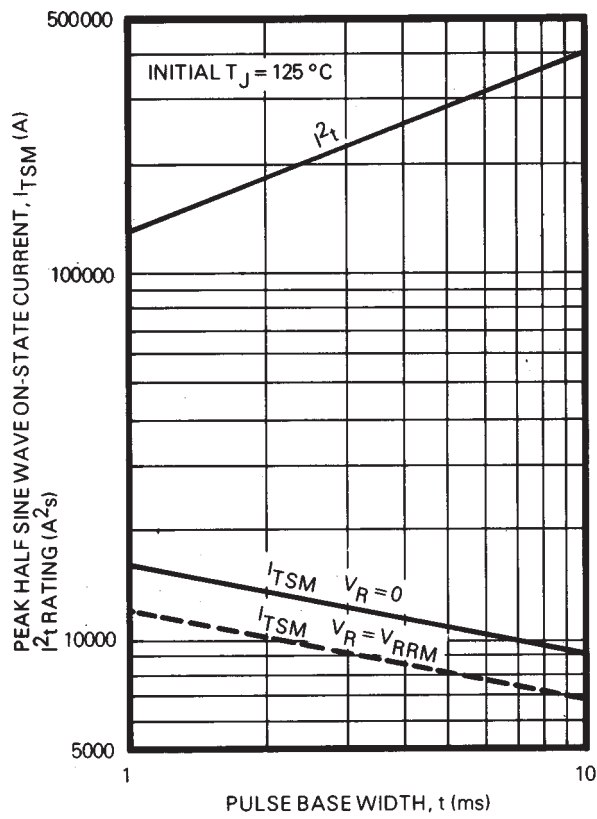
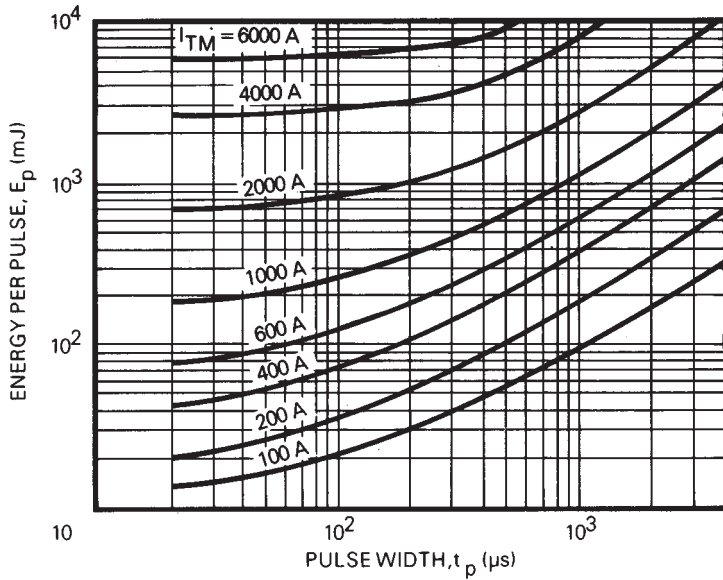
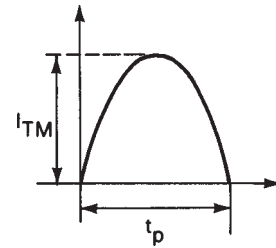


FIG. 5 NON-REPETITIVE SUB-CYCLE SURGE ON-STATE CURRENT AND  $I^2t$  RATING

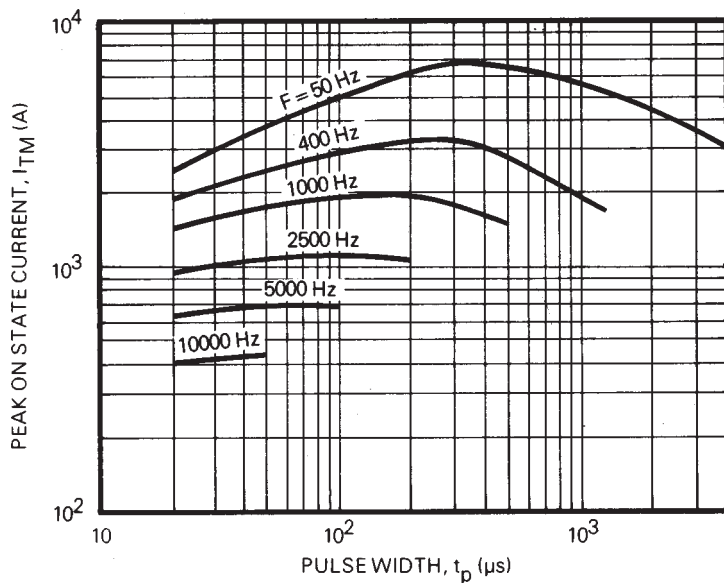


**NOTES:**

1.  $V_D \leq 600V$ .
2.  $V_R \leq 10V$ .
3. R.C Snubber,  $C = 0.22\mu F$ ,  $R = 4.7\Omega$

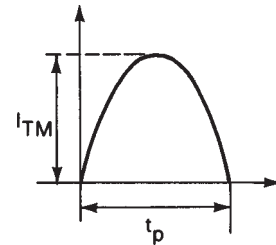


**FIG.6 ENERGY PER PULSE FOR SINUSOIDAL PULSES**

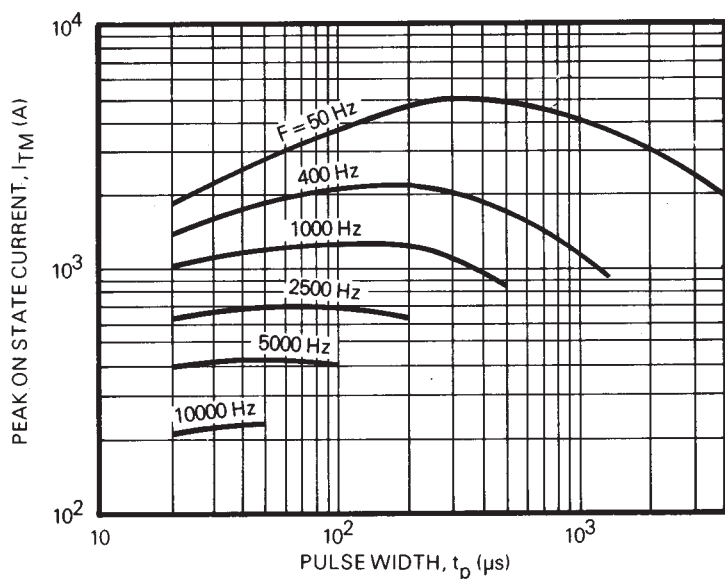


**NOTES:**

1.  $V_D \leq 600V$ .
2.  $V_R \leq 10V$ .
3. R.C Snubber,  $C = 0.22\mu F$ ,  $R = 4.7\Omega$

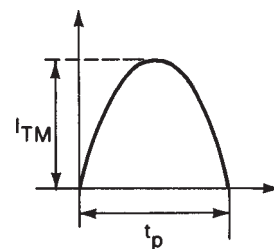


**FIG.7 MAXIMUM ALLOWABLE PEAK ON-STATE CURRENT vs PULSE WIDTH FOR  $T_c = 65^\circ C$**

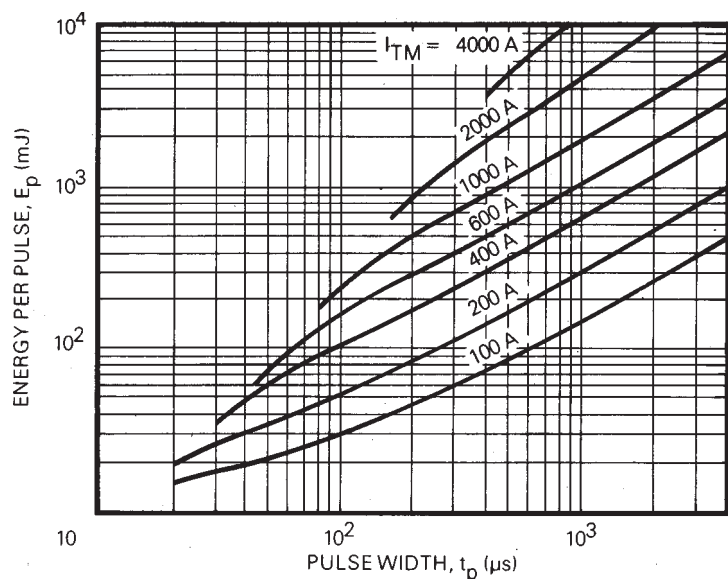


**NOTES:**

1.  $V_D \leq 600V$ .
2.  $V_R \leq 10V$ .
3. R.C Snubber,  $C = 0.22\mu F$ ,  $R = 4.7\Omega$

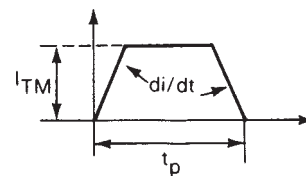


**FIG.8 MAXIMUM ALLOWABLE PEAK ON-STATE CURRENT vs PULSE WIDTH FOR  $T_c = 90^\circ C$**



**NOTES:**

1.  $di/dt = 25A/\mu s$
2.  $V_D \leq 600V$ .
3.  $V_R \leq 10V$ .
4. R.C Snubber,  $C = 0.22\mu F$ ,  $R = 4.7\Omega$



**FIG.9 ENERGY PER PULSE FOR TRAPEZOIDAL PULSES**

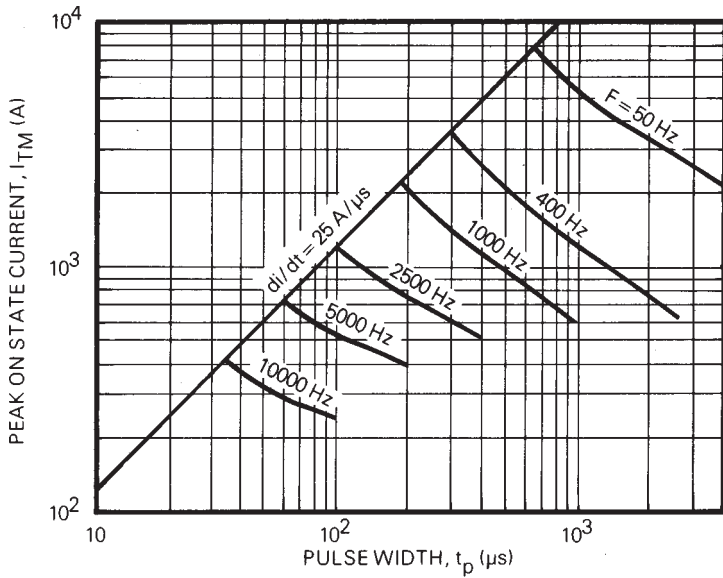


FIG.10 MAXIMUM ALLOWABLE PEAK ON-STATE CURRENT vs PULSE WIDTH FOR  $T_c = 65^\circ\text{C}$

**NOTES:**

1.  $di/dt = 25\text{A}/\mu\text{s}$
2.  $V_D \leq 600\text{V}$ .
3.  $V_R \leq 10\text{V}$ .
4. R.C Snubber,  $C = 0.22\mu\text{F}$ ,  $R = 4.7\Omega$

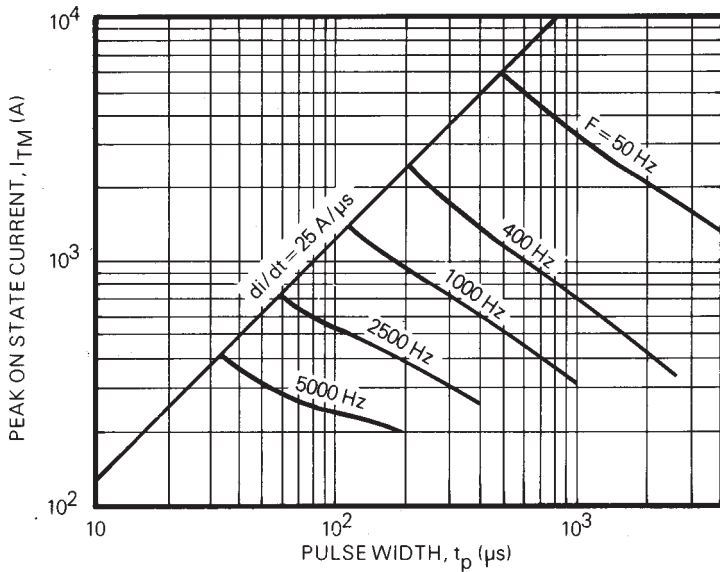
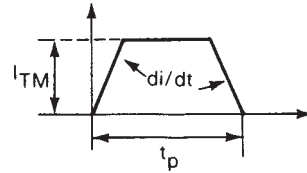
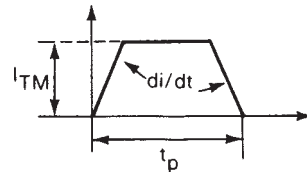


FIG.11 MAXIMUM ALLOWABLE PEAK ON-STATE CURRENT vs PULSE WIDTH FOR  $T_c = 90^\circ\text{C}$

**NOTES:**

1.  $di/dt = 25\text{A}/\mu\text{s}$
2.  $V_D \leq 600\text{V}$ .
3.  $V_R \leq 10\text{V}$ .
4. R.C Snubber,  $C = 0.22\mu\text{F}$ ,  $R = 4.7\Omega$





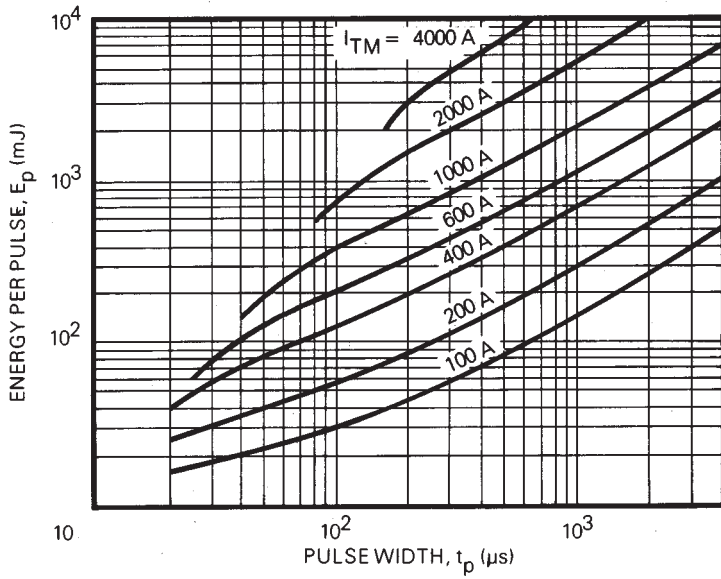


FIG.12 ENERGY PER PULSE FOR TRAPEZOIDAL PULSES

**NOTES:**

1.  $di/dt = 50A/\mu s$
2.  $V_D \leq 600V$ .
3.  $V_R \leq 10V$ .
4. R.C Snubber,  $C = 0.22\mu F$ ,  $R = 4.7\Omega$

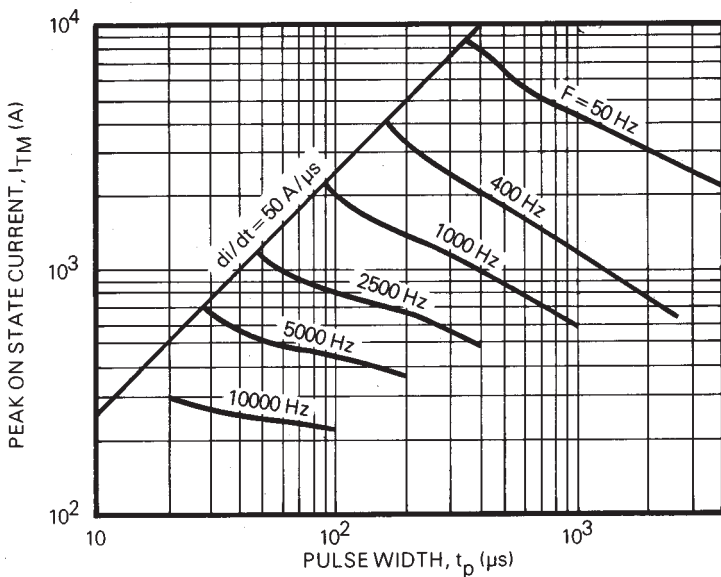
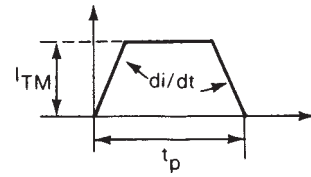
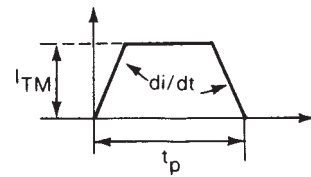


FIG.13 MAXIMUM ALLOWABLE PEAK ON-STATE CURRENT vs PULSE WIDTH FOR  $T_c = 65^\circ C$

**NOTES:**

1.  $di/dt = 50A/\mu s$
2.  $V_D \leq 600V$ .
3.  $V_R \leq 10V$ .
4. R.C Snubber,  $C = 0.22\mu F$ ,  $R = 4.7\Omega$



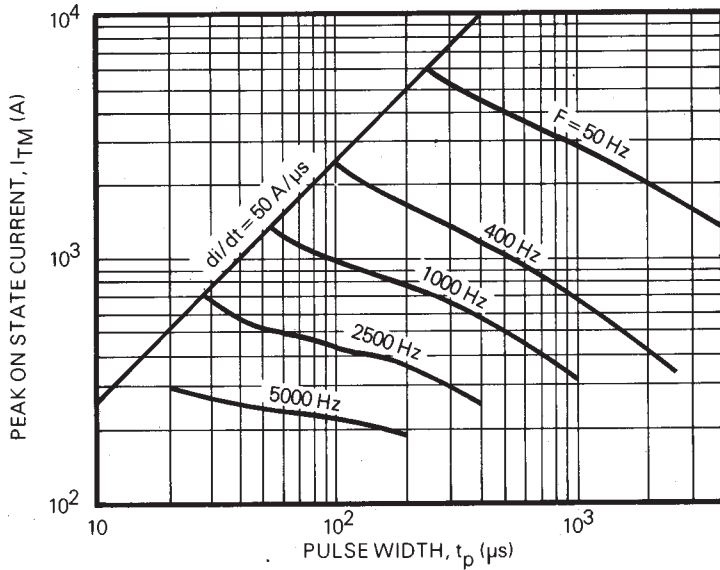


FIG. 14 MAXIMUM ALLOWABLE PEAK ON-STATE CURRENT vs PULSE WIDTH FOR  $T_c = 90^\circ C$

**NOTES:**

1.  $di/dt = 50 A/\mu s$
2.  $V_D \leq 600V$ .
3.  $V_R \leq 10V$ .
4. R.C Snubber,  $C = 0.22\mu F$ ,  $R = 4.7\Omega$

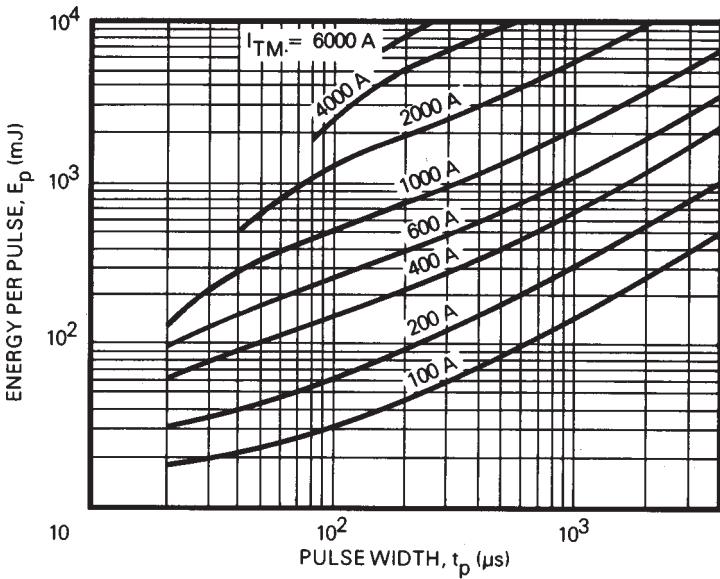
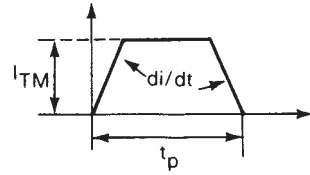
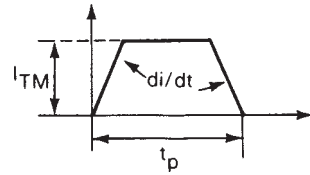


FIG. 15 ENERGY PER PULSE FOR TRAPEZOIDAL PULSES

**NOTES:**

1.  $di/dt = 100 A/\mu s$
2.  $V_D \leq 600V$ .
3.  $V_R \leq 10V$ .
4. R.C Snubber,  $C = 0.22\mu F$ ,  $R = 4.7\Omega$



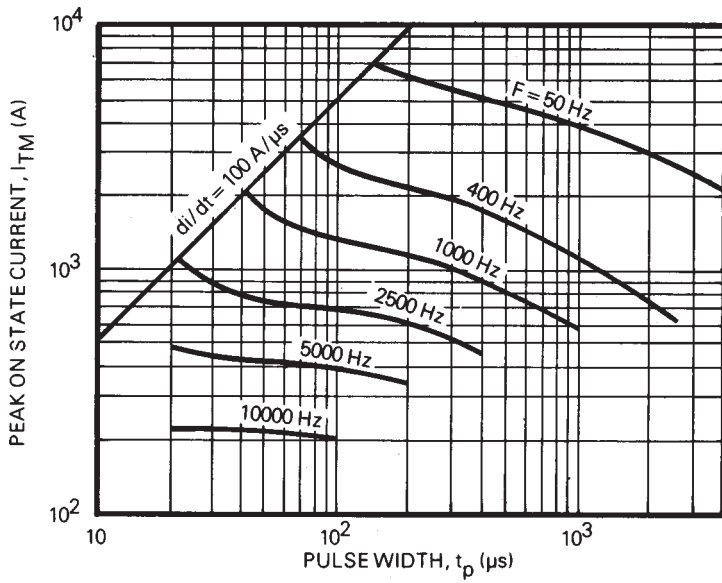


FIG.16 MAXIMUM ALLOWABLE PEAK ON-STATE CURRENT vs PULSE WIDTH FOR  $T_c = 65^\circ C$

**NOTES:**

1.  $di/dt = 100A/\mu s$
2.  $V_D \leq 600V$ .
3.  $V_R \leq 10V$ .
4. R.C Snubber,  $C = 0.22\mu F$ ,  $R = 4.7\Omega$

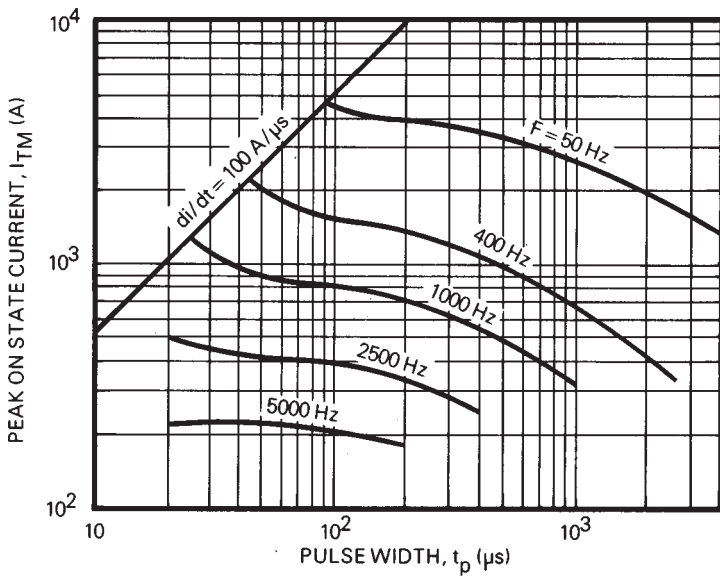
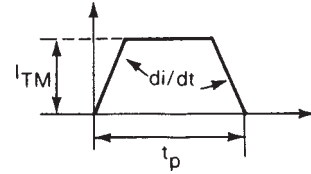
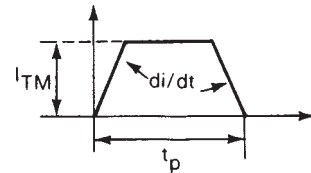


FIG.17 MAXIMUM ALLOWABLE PEAK ON-STATE CURRENT vs PULSE WIDTH FOR  $T_c = 90^\circ C$

**NOTES:**

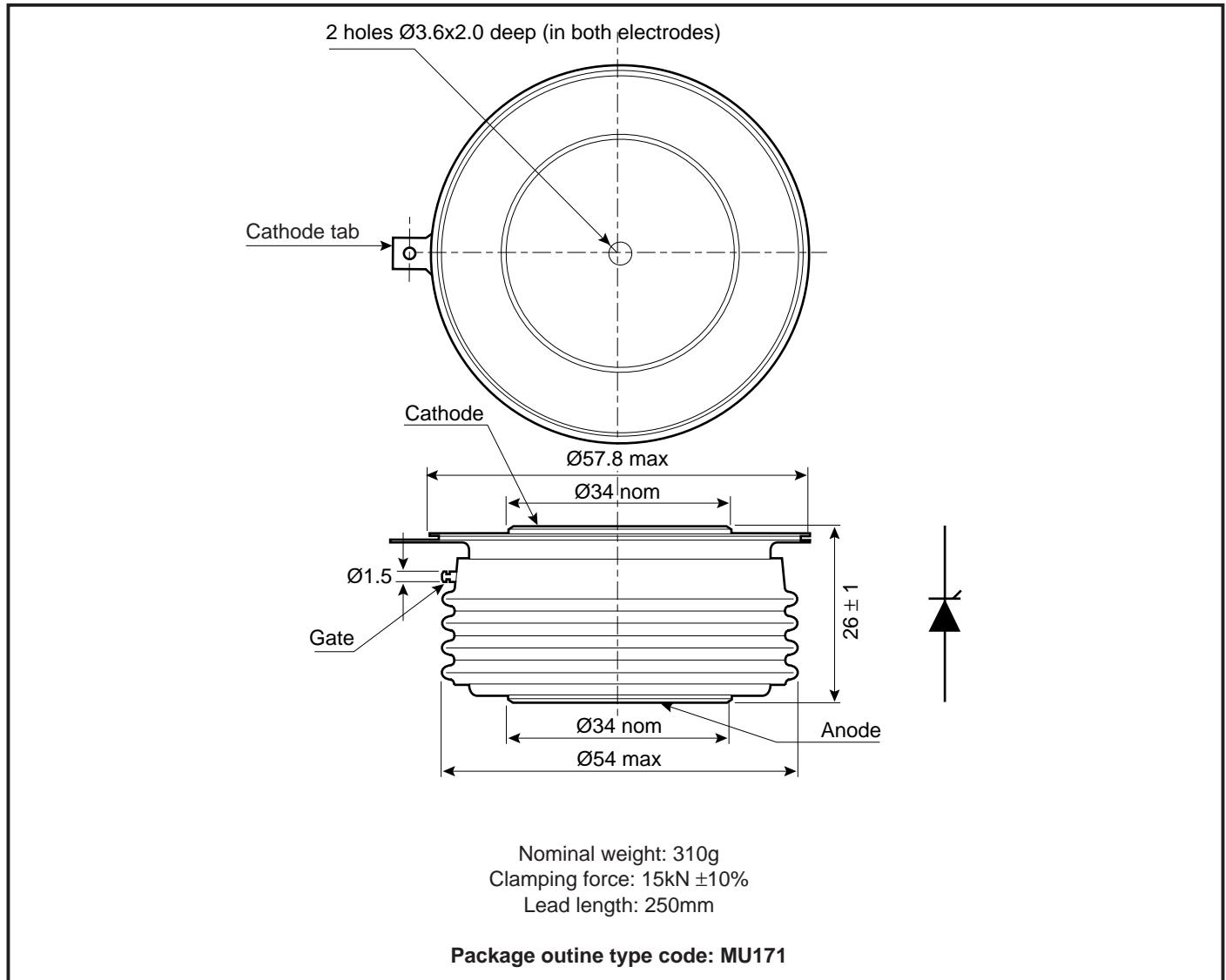
1.  $di/dt = 100A/\mu s$
2.  $V_D \leq 600V$ .
3.  $V_R \leq 10V$ .
4. R.C Snubber,  $C = 0.22\mu F$ ,  $R = 4.7\Omega$



## TF666..A

### PACKAGE DETAILS

For further package information, please contact your local Customer Service Centre. All dimensions in mm, unless stated otherwise. DO NOT SCALE.



### ASSOCIATED PUBLICATIONS

Title	Application Note Number
Calculating the junction temperature or power semiconductors	AN4506
Gate triggering and the use of gate characteristics	AN4840
Recommendations for clamping power semiconductors	AN4839
The effect of temperature on thyristor performance	AN4870
Thyristor and diode measurement with a multi-meter	AN4853
Turn-on performance of thyristors in parallel	AN4999
Use of $V_{TO}$ , $r_T$ on-state characteristic	AN5001

## POWER ASSEMBLY CAPABILITY

The Power Assembly group was set up to provide a support service for those customers requiring more than the basic semiconductor, and has developed a flexible range of heatsink / clamping systems in line with advances in device types and the voltage and current capability of our semiconductors.

We offer an extensive range of air and liquid cooled assemblies covering the full range of circuit designs in general use today. The Assembly group continues to offer high quality engineering support dedicated to designing new units to satisfy the growing needs of our customers.

Using the up to date CAD methods our team of design and applications engineers aim to provide the Power Assembly Complete solution (PACs).

## DEVICE CLAMPS

Disc devices require the correct clamping force to ensure their safe operation. The PACs range offers a varied selection of pre-loaded clamps to suit all of our manufactured devices. This include cube clamps for single side cooling of 'T' 22mm

Clamps are available for single or double side cooling, with high insulation versions for high voltage assemblies.

Please refer to our application note on device clamping, AN4839

## HEATSINKS

Power Assembly has it's own proprietary range of extruded aluminium heatsinks. They have been designed to optimise the performance of our semiconductors. Data with respect to air natural, forced air and liquid cooling (with flow rates) is available on request.

For further information on device clamps, heatsinks and assemblies, please contact your nearest Sales Representative or the factory.



<http://www.dynexsemi.com>

e-mail: [power\\_solutions@dynexsemi.com](mailto:power_solutions@dynexsemi.com)

HEADQUARTERS OPERATIONS  
**DYNEX SEMICONDUCTOR LTD**  
 Doddington Road, Lincoln.  
 Lincolnshire. LN6 3LF. United Kingdom.  
 Tel: 00-44-(0)1522-500500  
 Fax: 00-44-(0)1522-500550

**DYNEX POWER INC.**  
 Unit 7 - 58 Antares Drive,  
 Nepean, Ontario, Canada K2E 7W6.  
 Tel: 613.723.7035  
 Fax: 613.723.1518  
 Toll Free: 1.888.33.DYNEX (39639)

CUSTOMER SERVICE CENTRES  
**France, Benelux, Italy and Spain** Tel: +33 (0)1 69 18 90 00. Fax: +33 (0)1 64 46 54 50  
**North America** Tel: 011-800-5554-5554. Fax: 011-800-5444-5444  
**UK, Germany, Scandinavia & Rest Of World** Tel: +44 (0)1522 500500. Fax: +44 (0)1522 500020

SALES OFFICES  
**France, Benelux, Italy and Spain** Tel: +33 (0)1 69 18 90 00. Fax: +33 (0)1 64 46 54 50  
**Germany** Tel: 07351 827723  
**North America** Tel: (613) 723-7035. Fax: (613) 723-1518. Toll Free: 1.888.33.DYNEX (39639) /  
 Tel: (831) 440-1988. Fax: (831) 440-1989 / Tel: (949) 733-3005. Fax: (949) 733-2986.  
**UK, Germany, Scandinavia & Rest Of World** Tel: +44 (0)1522 500500. Fax: +44 (0)1522 500020  
 These offices are supported by Representatives and Distributors in many countries world-wide.  
 © Dynex Semiconductor 2000 Publication No. DS4274-3 Issue No. 3.0 January 2000  
 TECHNICAL DOCUMENTATION – NOT FOR RESALE. PRINTED IN UNITED KINGDOM

### Datasheet Annotations:

Dynex Semiconductor annotate datasheets in the top right hand corner of the front page, to indicate product status. The annotations are as follows:-

**Target Information:** This is the most tentative form of information and represents a very preliminary specification. No actual design work on the product has been started.

**Preliminary Information:** The product is in design and development. The datasheet represents the product as it is understood but details may change.

**Advance Information:** The product design is complete and final characterisation for volume production is well in hand.

**No Annotation:** The product parameters are fixed and the product is available to datasheet specification.

This publication is issued to provide information only which (unless agreed by the Company in writing) may not be used, applied or reproduced for any purpose nor form part of any order or contract nor to be regarded as a representation relating to the products or services concerned. No warranty or guarantee express or implied is made regarding the capability, performance or suitability of any product or service. The Company reserves the right to alter without prior notice the specification, design or price of any product or service. Information concerning possible methods of use is provided as a guide only and does not constitute any guarantee that such methods of use will be satisfactory in a specific piece of equipment. It is the user's responsibility to fully determine the performance and suitability of any equipment using such information and to ensure that any publication or data used is up to date and has not been superseded. These products are not suitable for use in any medical products whose failure to perform may result in significant injury or death to the user. All products and materials are sold and services provided subject to the Company's conditions of sale, which are available on request.

All brand names and product names used in this publication are trademarks, registered trademarks or trade names of their respective owners.