

## 2 - 6 GHz Gain Block Amplifier

## TGA8226-SCC

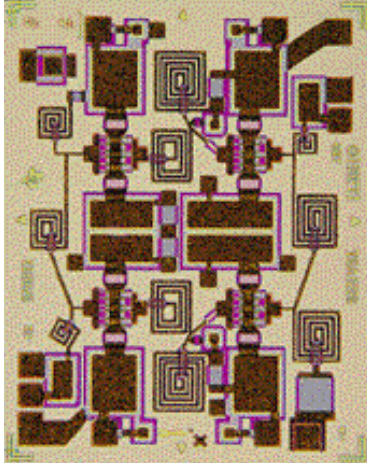

### Key Features and Performance

- 2 to 6 GHz Frequency Range
- 13.5 dB Gain
- 17 dBm Output Power at 1 dB Gain Compression
- 5.5 dB Noise Figure
- Operates from Single 15V Supply
- 1.47 x 1.85 x 0.15 mm (0.058 x 0.073 x 0.006 in.)

### Description

The TriQuint TGA8226-SCC is a self biased distributed amplifier and operates from a single 15 V supply. Four 457  $\mu$ m FETs produce a typical gain greater than 13.5 dB, with input and output SWRs less than 2:1. Direct cascading without additional components is possible by using the on-chip blocking capacitors. Ground is provided to the circuitry through vias to the backside metallization.

Bond pad and backside metallization is gold plated for compatibility with eutectic alloy attachment methods as well as thermocompression and thermosonic wire-bonding processes. The TGA8226-SCC is available in chip form and is readily assembled using automated equipment.

**TYPICAL  
SMALL-SIGNAL  
POWER GAIN**

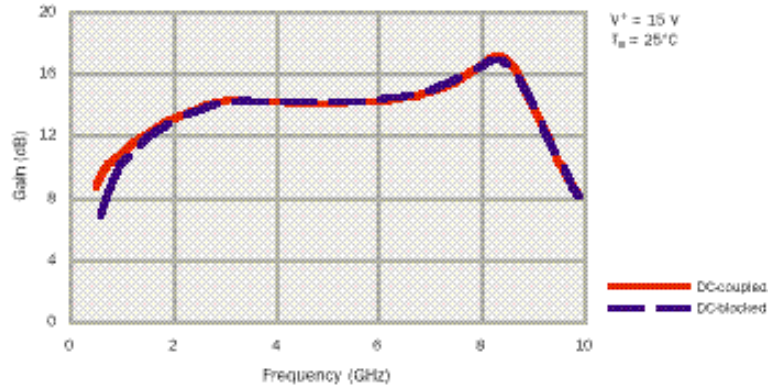

**TYPICAL  
NOISE FIGURE**

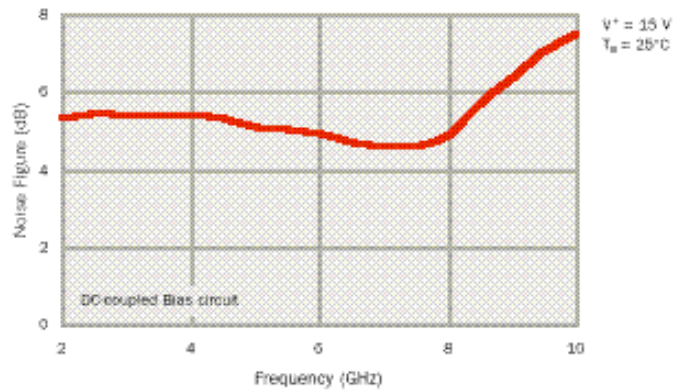

**TYPICAL  
OUTPUT POWER  
 $P_{1dB}$**

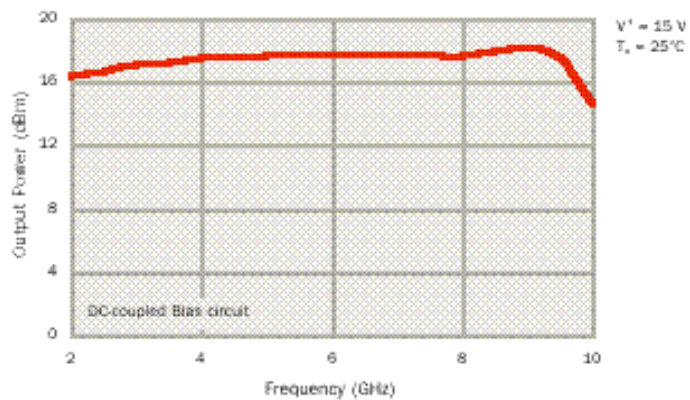

**TYPICAL  
INPUT RETURN LOSS**

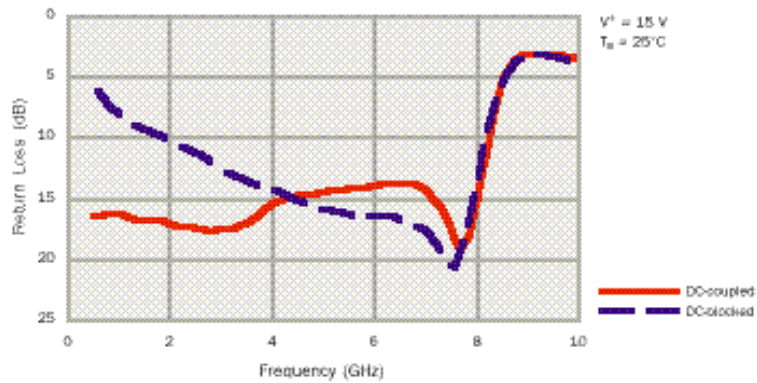

**TYPICAL  
OUTPUT RETURN LOSS**

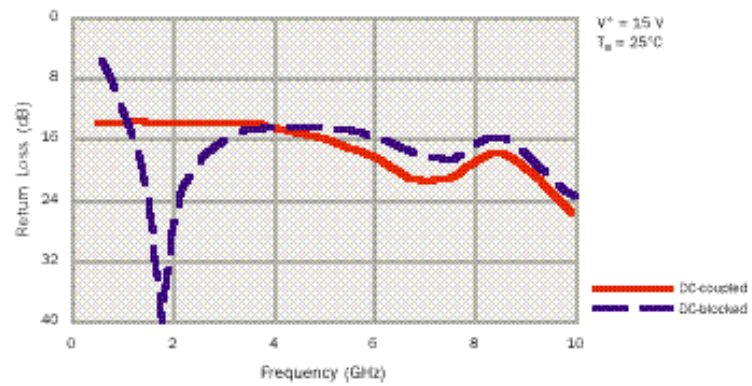

**ABSOLUTE  
MAXIMUM  
RATINGS**

Positive supply voltage, V+	18 V
Power dissipation, P <sub>D</sub> at (or below) 25°C base-plate temperature *	4.4 W
Input continuous-wave power, P <sub>IN</sub>	23 dB
Operating Channel temperature, T <sub>CH</sub> **	150°C
Mounting temperature (30 sec.), T <sub>M</sub>	320°C
Storage temperature range, T <sub>STG</sub>	-65 to 150°C

**Ratings over operating channel temperature range, T<sub>CH</sub> (unless otherwise noted).**

Stresses beyond those listed under "Absolute Maximum Ratings" may cause permanent damage to the device. These are stress ratings only and functional operation of the device at these or any other conditions beyond those indicated under "RF Characteristics" is not implied. Exposure to absolute maximum rated conditions for extended periods may affect device reliability.

\* For operation above 25°C base-plate temperature, derate linearly at the rate of 9.2 mW/°C.

\*\* Operating channel temperature (T<sub>CH</sub>) directly affects the device MTTF. For maximum life, it is recommended that channel temperature be maintained at the lowest possible level.

### TYPICAL S-PARAMETERS

Frequency (GHz)	S <sub>11</sub>		S <sub>21</sub>		S <sub>12</sub>		S <sub>22</sub>		GAIN (dB)
	MAG	ANG(°)	MAG	ANG(°)	MAG	ANG(°)	MAG	ANG(°)	
0.5	0.15	7	2.70	21	0.000	30	0.21	153	8.6
1.0	0.15	-20	3.47	-6	0.001	104	0.20	125	10.8
1.5	0.14	-44	4.01	-27	0.001	124	0.21	100	12.1
2.0	0.14	-73	4.49	-49	0.002	124	0.20	80	13.1
2.5	0.13	-104	4.89	-72	0.004	119	0.20	62	13.8
3.0	0.13	-133	5.14	-95	0.006	110	0.20	48	14.2
3.5	0.14	-155	5.15	-118	0.009	88	0.20	34	14.2
4.0	0.16	-174	5.10	-139	0.008	64	0.19	22	14.2
4.5	0.18	169	5.07	-160	0.007	57	0.17	12	14.1
5.0	0.19	157	5.06	180	0.008	50	0.16	0	14.1
5.5	0.19	148	5.08	160	0.008	37	0.14	-12	14.1
6.0	0.20	140	5.13	140	0.008	21	0.12	-21	14.2
6.5	0.20	130	5.27	119	0.008	-5	0.10	-24	14.4
7.0	0.19	111	5.49	98	0.008	-33	0.08	-14	14.8
7.5	0.13	73	5.97	75	0.011	-68	0.09	-10	15.5
8.0	0.16	-38	6.73	46	0.017	-106	0.11	-24	16.6
8.5	0.50	-117	7.01	3	0.023	-154	0.13	-73	16.9
9.0	0.69	-168	5.07	-38	0.022	165	0.10	-128	14.1
9.5	0.69	162	3.37	-65	0.018	141	0.07	-160	10.6
10.0	0.65	144	2.38	-86	0.015	128	0.05	176	7.5

V<sup>+</sup> = 15 V, T<sub>A</sub> = 25°C, DC-coupled bias and external DC blocks

Reference planes for S-parameter data include bond wires as specified in the "Recommended Assembly Diagram". The S-parameters are also available on floppy disk and the world wide web.

### RF CHARACTERISTICS

PARAMETER		TEST CONDITIONS	TYP	UNIT
G <sub>p</sub>	Small-signal power gain	f = 2 to 6 GHz	13.5	dB
SWR(in)	Input standing wave ratio	f = 2 to 6 GHz	1.4:1	-
SWR(out)	Output standing wave ratio	f = 2 to 6 GHz	1.4:1	-
P <sub>1dB</sub>	Output power at 1-dB gain compression	f = 2 to 6 GHz	17	dBm
NF	Noise figure	f = 2 to 6 GHz	5.5	dB
IP <sub>3</sub>	Output third-order intercept point	f = 2 GHz	26	dBm
		f = 4 GHz	28	
		f = 6 GHz	27	

V<sup>+</sup> = 15 V, T<sub>A</sub> = 25°C, DC-coupled bias and external DC blocks

### DC CHARACTERISTICS

PARAMETER	TEST CONDITIONS	TYP	UNIT	
I <sup>+</sup>	Positive supply current	V <sup>+</sup> = 15 V T <sub>A</sub> = 25°C	68	mA

T<sub>A</sub> = 25°C

**EQUIVALENT SCHEMATIC**

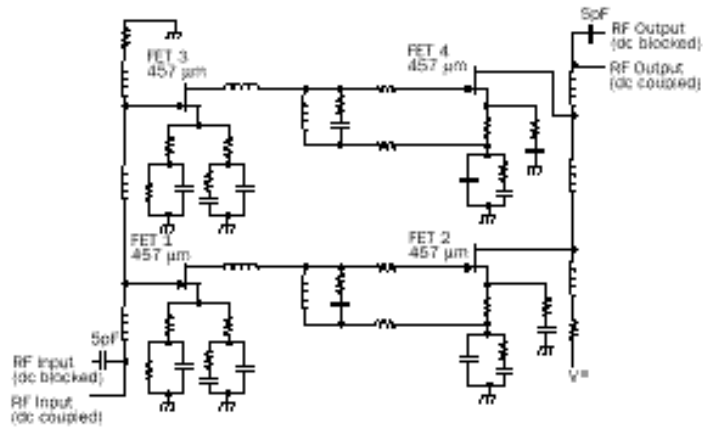

**TYPICAL BIAS NETWORK**

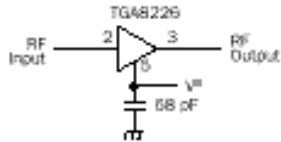

(DC-Blocked Bias Circuit)

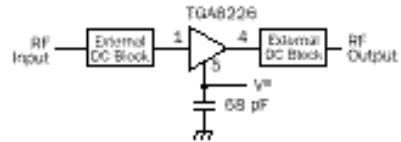

(DC-Coupled Bias Circuit)

**RECOMMENDED  
ASSEMBLY DIAGRAM**  
DC-Blocked Bias Circuit

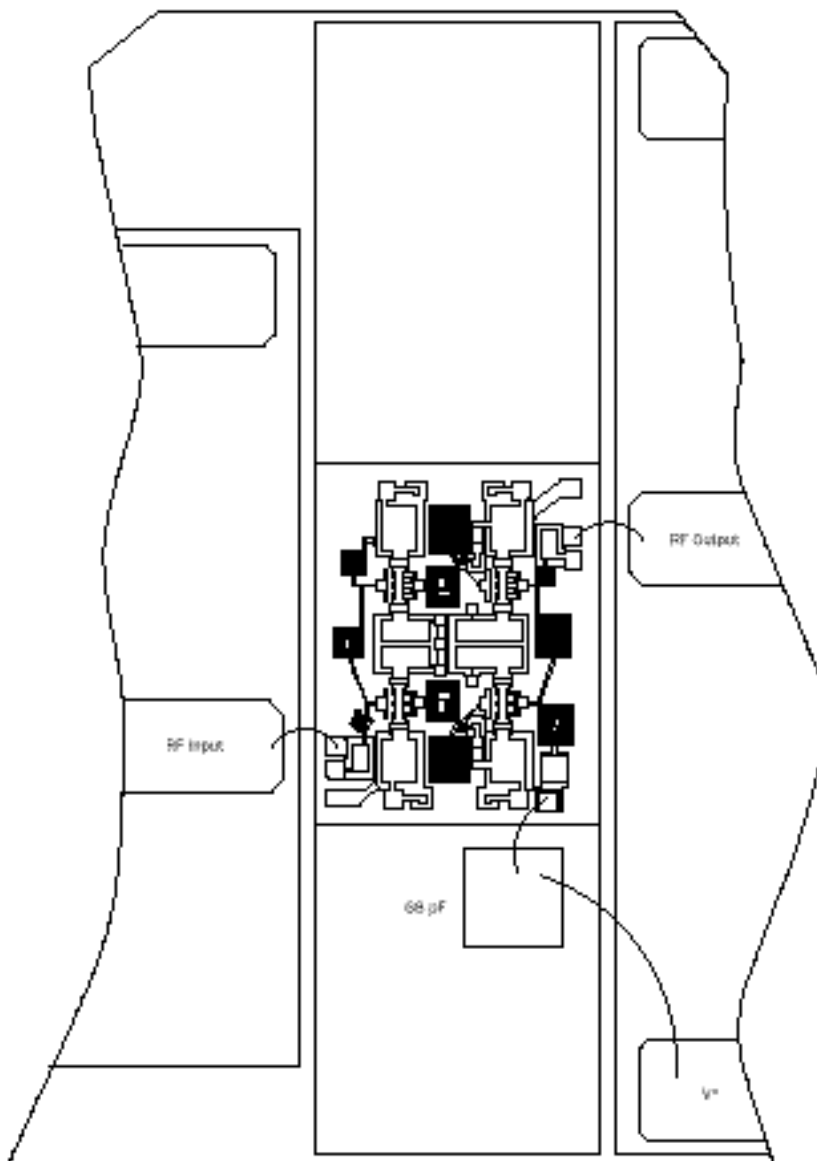

RF connections: Bond using 1-mil diameter, 15-mil-length gold bond wires at both RF Input and RF Output for optimum RF performance.

Close placement of external components is essential to stability.

Refer to TriQuint's Recommended Assembly Instructions for GaAs Products.

**RECOMMENDED  
ASSEMBLY DIAGRAM**  
DC-Coupled Circuit

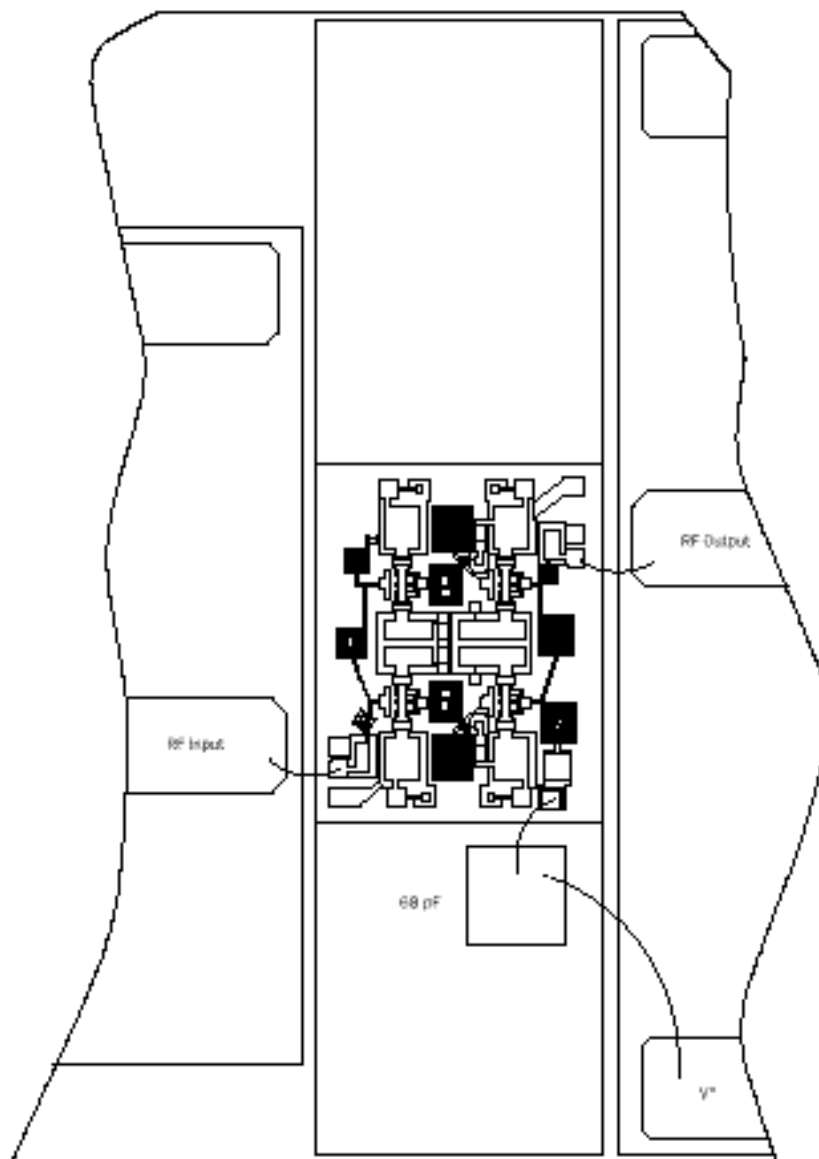

RF connections: Bond using 1-mil diameter, 15-mil-length gold bond wires at both RF Input and RF Output for optimum RF performance.

Close placement of external components is essential to stability.

Refer to TriQuint's Recommended Assembly Instructions for GaAs Products.

***GaAs MMIC devices are susceptible to damage from Electrostatic Discharge. Proper precautions should be observed during handling, assembly and test.***

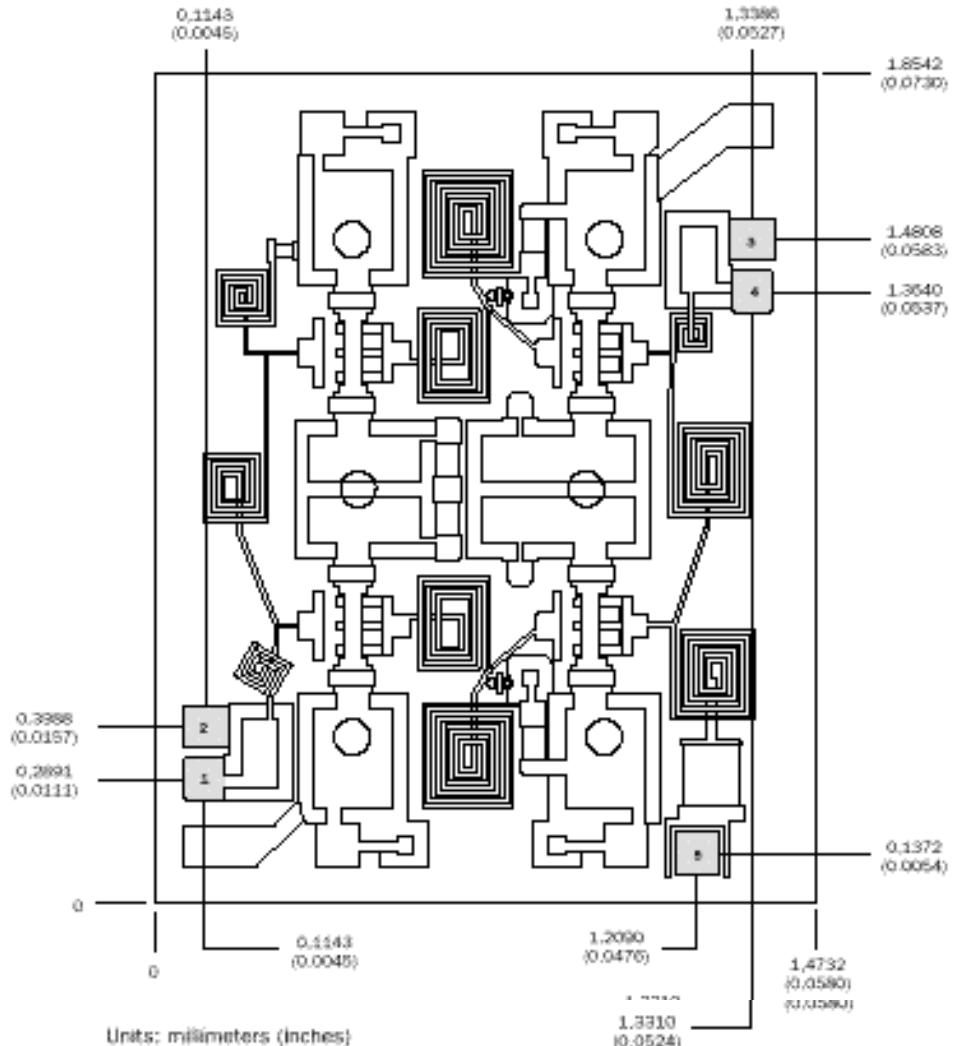

Units: millimeters (Inches)  
 Thickness: 0.1524 (0.006) (reference only)  
 Chip edge to bond pad dimensions are shown to center of bond pad.  
 Chip size tolerance:  $\pm 0.0508$  (0.002)

Bond pad #1 RF Input (dc coupled):	0.0965 x 0.0991 (0.0038 x 0.0039)
Bond pad #2 RF Input (dc blocked):	0.0864 x 0.0991 (0.0034 x 0.0039)
Bond pad #3 RF Output (dc blocked):	0.0889 x 0.0991 (0.0035 x 0.0039)
Bond pad #4 RF Output (dc coupled):	0.0965 x 0.0991 (0.0038 x 0.0039)
Bond pad #5 (V <sup>+</sup> ):	0.0965 x 0.1092 (0.0038 x 0.0043)

**GaAs MMIC devices are susceptible to damage from Electrostatic Discharge. Proper precautions should be observed during handling, assembly and test.**